

# Express

*125 and 250 Lighting control system  
Version 3.1*

Copyright © Electronic Theatre Controls, Inc.

All Rights reserved.

Product information and specifications subject to change.

Part Number: 4110M1008 Rev A

Released: December 2000



# Contents

<b>Chapter 1</b>	
<b>Introduction</b>	1
Using this manual	2
Setting up the console	2
New users	2
Keyboard Help	2
Text conventions	2
Navigation and visual feedback	3
Output level conventions	4
HTP channels	4
LTP Channels	4
Enabling LTP	5
Working with LTP channels	5
Moving light concepts and terms	7
Fixtures	7
Fixture attributes	7
Categories	7
Personalities	7
The Only command	8
When working with fixtures	8
When updating	8
When recalling channels	8
Using the trackpad	9
Trackpad notes:	9
Sensitivity	9
Electronic backup maintenance	10
Troubleshooting	10
Help from ETC Technical Services	11
<b>Chapter 2</b>	
<b>Monitor displays</b>	13
Colors in displays	14
Channel numbers/Standard patch	14
Channel numbers/Fixture patch	14
Channel output levels	14
Changing pages	14
Display features	15
Stage	16
Blind	16
Fader	17
Flexichannel	18
Updating Flexichannel	18
Patch	19
<b>Chapter 3</b>	
<b>System settings</b>	21
Setting the number of dimmers	22
Setting the number of channels	23
Setting default fade times	24
Setting default Level key	25
Setting default fader clear time	25

Setting default sneak time	26
Enable / disable Blackout key	27
Enable / disable Flexichannel	27
Set grandmaster type	28
Set channels / submasters 1-to-1	28
Record lockout	29
Enable / disable bump buttons	29
Setting the clock	30
Clock functions display	30
Daylight Savings Time	31
Set time/date	31
12/24 hour clock	31
Latitude, longitude, time zone	32
About Show	33

## Chapter 4

<b>Patching channels</b>	35
Selecting one-to-one patch	36
Creating a custom patch	37
Proportional patching	38
Unpatching individual dimmers	39
Show labels	39
Dimmer profiles	40
Pre-defined profiles	40
Assigning a profile to a dimmer	41
Profiles display	41
Creating or editing a profile	42
Copying to another profile	42
Clear All	43
Clear to End	43
Fill Between	43
Resetting a profile	43
Captured channels in Patch	44
Dimmer check	45
About Dimmer	46
About Dimmer with ETCLink	47
Setting dimmers to Dimmer Doubling	48
Patching to a Strand CD80 dimmer rack	49

## Chapter 5

<b>Setting channel levels</b>	51
Channel modes	52
Selected channels	52
Captured channels	52
Recorded channels	52
Moving channels	52
Tracked channels	52
Channel Attributes display	53
Editing in the Channel Attributes display	54
Independent channels	54
Flipped channels	54
Channel data type	55
Channel convention	55
Selecting channels	56
Selecting channels in Flexichannel mode	56

Setting channel levels .....	57
Trackpad .....	57
Full .....	57
Level key .....	57
Flash .....	57
Sneak .....	58
Channel check .....	59
About Channel .....	60
Features of the display .....	60

## Chapter 6

<b>Adding moving lights to the show</b> .....	63
Moving Light Functions menu .....	64
Personality Setup .....	65
Go to the Personality Setup display .....	65
Loading personalities into the console .....	66
Viewing a personality .....	67
Deleting personalities .....	67
Resetting defaults .....	67
Patching moving lights .....	68
Go to the Fixture Patch display .....	68
Patching one fixture or a fixture range .....	69
Editing the fixture list .....	70
Attribute Setup .....	71
Go to the Attribute Setup display .....	72
Encoder Setup .....	73
Go to the Encoder Setup display .....	73
Changing assignments .....	74
Working with moving lights .....	75
Moving lights displays .....	75
Go to the Fixture Box window .....	75
Working with fixtures .....	76
Setting levels in the Fixture Box .....	77
Fixture focus with Solo .....	78

## Chapter 7

<b>Cues</b> .....	79
Cue types .....	80
Crossfade .....	80
Allfade .....	80
Effect .....	80
Blocking .....	80
Subroutine .....	80
Recording functions .....	81
Viewing cues .....	81
The oversized show .....	82
Creating the oversized show .....	82
Playing back an oversized show .....	82
Working with cues in Stage .....	83
Recording a cue in Stage .....	83
Working with cues in Blind .....	84
Recording a cue in Blind .....	84
Recording a cue with a single fade time .....	85
Recording a cue with split fade times .....	86
Recording a cue with a wait time .....	87

Recording cues with Link and Follow . . . . .	88
Link . . . . .	88
Follow . . . . .	89
Create playback loops with Link and Follow . . . . .	90
Linking a macro to a cue . . . . .	91
Recording a cue using Solo . . . . .	92
Using Solo to record selected lights . . . . .	92
Using Solo as a pre-recording filter . . . . .	92
Labeling cues . . . . .	93
Modifying a recorded cue live . . . . .	94
Modifying channels in a cue . . . . .	94
Modifying cue attributes . . . . .	95
Updating cues . . . . .	96
Using Update to modify fade rate . . . . .	98
Deleting cues . . . . .	98
Copying cues . . . . .	99
Inserting cues . . . . .	100

## Chapter 8

<b>Track</b> . . . . .	101
Track record . . . . .	102
Using record to create tracks . . . . .	102
Recording modified cues . . . . .	103
Inserting cues . . . . .	105
Blackout cues and tracking . . . . .	108

## Chapter 9

<b>Multipart cues</b> . . . . .	111
Recording a multipart cue . . . . .	112
Converting a standard cue to a multipart cue . . . . .	113
Wait times in multipart cues . . . . .	114
Editing a multipart cue . . . . .	115
Deleting a part from a multipart cue . . . . .	115
Adding, deleting and modifying channels . . . . .	116
Using Update . . . . .	116
Modifying fade and wait times . . . . .	117

## Chapter 10

<b>Playing back cues</b> . . . . .	119
Fader keys . . . . .	121
Clear . . . . .	121
Go . . . . .	121
Hold . . . . .	121
Back . . . . .	121
Cue List . . . . .	122
Fader Status display . . . . .	123
Selecting cues . . . . .	123
Playing a cue . . . . .	124
Go to a different cue . . . . .	124
Controlling fades manually . . . . .	125
Manual override . . . . .	125
Rate override . . . . .	126
Quickstep . . . . .	127

## Chapter 11

<b>Groups</b> .....	129
Recording a group in Stage .....	130
Recording a group from a look on stage .....	130
Recording a group using Solo .....	131
Working with groups in Blind .....	131
Group mode .....	131
Group Editing mode in Blind .....	132
Working with groups in Stage .....	133
Displaying a group .....	133
Modifying a group .....	133
Updating groups .....	134
Labeling groups .....	136
Deleting groups .....	137
Copying groups .....	137
Using cues and submasters as groups .....	138
Modifying cues or submasters .....	139

## Chapter 12

<b>Focus points</b> .....	141
Recording a focus point .....	142
Recording a focus point in Stage .....	142
Creating a focus point from a look on stage .....	142
Recording a focus point using Solo .....	143
Working with focus points in Stage .....	144
Placing a focus point on stage .....	144
Modifying a focus point .....	144
Updating focus points .....	145
Editing a focus point in Blind .....	147
Labeling focus points .....	148
Deleting focus points .....	149
Copying focus points .....	149
Setting levels with focus points .....	150

## Chapter 13

<b>Submasters</b> .....	151
Submaster types .....	152
Pile-on submaster .....	152
Inhibitive submaster .....	152
Effect submaster .....	152
Changing type .....	153
Submaster pages .....	154
Submaster bump buttons .....	155
Bump button status .....	155
Submaster LEDs .....	156
Recording submasters .....	157
Fade and dwell times for submasters .....	157
Adding a rate to a submaster .....	160
Specifying a submaster's page .....	161
Using Except to record a submaster .....	161
Inhibitive submasters .....	162
Creating .....	162
Adding channels .....	163
Deleting channels .....	163

Modifying submasters in Blind .....	164
Modifying submasters in Stage .....	164
Re-recording submasters .....	164
Updating submasters .....	165
Live control of a submaster's rate .....	167
Controlling submaster fades manually .....	167
Labeling submasters .....	168
Copying submasters .....	169
Loading cues or groups to submasters .....	169
Copying cues or groups to submasters .....	170
Clearing submasters .....	170

## Chapter 14

<b>Lists and spreadsheets</b> .....	171
Cue List .....	172
Editing cues .....	172
Submaster List .....	173
Editing submasters .....	174
Deleting submasters .....	175
Group List .....	176
Labeling a group .....	176
Deleting a group .....	177
Focus Point List .....	177
Labeling a focus point .....	178
Deleting a focus point .....	178
Working in spreadsheets .....	179
Cue spreadsheet .....	179
Submaster spreadsheet .....	182
Group spreadsheet .....	184
Focus point spreadsheet .....	186

## Chapter 15

<b>Park</b> .....	189
Using the Park display .....	190
Parking dimmers .....	190
Unparking dimmers .....	191
Unparking one dimmer .....	191
Unparking all dimmers .....	191
Parking channels .....	192
Using the keyboard .....	192
Parking at a focus point .....	192
Unparking channels .....	193
Unparking one channel .....	193
Unparking all channels .....	193
Parking recorded channels .....	194
Unparking recorded channels .....	194
Parking fixtures .....	195
After setting attribute levels from the keypad .....	195
After setting attribute levels at a focus point .....	195
Unparking fixtures .....	196

## Chapter 16

<b>Effects</b> .....	197
Blind Effects display .....	198
Features .....	198



Effects in Stage .....	199
Creating an effect in Blind .....	200
Notes on working with steps in Blind .....	201
Adding channels directly .....	201
Adding groups or focus points .....	202
Adding grouped channels .....	203
Creating an effect in Stage .....	204
Notes on working with steps in Stage .....	204
Adding channels directly .....	204
Adding groups or focus points .....	205
Adding grouped channels .....	206
Modifying the effect .....	207
Using Update .....	207
Editing channel levels .....	208
Adding channels .....	208
Deleting channels .....	209
Inserting steps .....	210
Deleting steps .....	211
Modifying effect attributes .....	212
Modifying step timing and levels .....	213
Effect fade times .....	214
Changing upfade, dwell and downfade .....	215
Changing upfade only .....	215
Changing downfade only .....	215
Changing dwell only .....	216
Resetting hold dwell time .....	216
Setting a random effect rate .....	217
Running an effect cue .....	217
Using an effect submaster .....	217

## Chapter 17

<b>Subroutines</b> .....	219
Steps .....	220
Cue steps .....	220
Style steps .....	221
Subroutine attributes .....	221
Creating subroutines .....	222
Editing a subroutine .....	224
Deleting a step .....	224
Inserting a step .....	224

## Chapter 18

<b>Macros</b> .....	225
Creating macros .....	226
Using Learn .....	226
Using Macro Editing .....	228
Macro wait .....	229
Linking macros .....	230
Using submasters in macros .....	231
Playing macros .....	232
Canceling a macro .....	232
Powerup macro .....	232
Modifying macros .....	233
Clearing macros .....	233
Copying macros .....	234
Sample macros .....	234

<b>Chapter 19</b>	
<b>Link lists</b>	237
Link List overview	238
Setting up a link	239
Inserting a link	240
Moving a link	241
Merging two links	241
Deleting a link	242
Using a link	242
<b>Chapter 20</b>	
<b>Diskette functions</b>	243
Diskette management	244
Formatting diskettes	244
Contents of the showfile	245
Writing to diskette	245
Reading from diskette	246
Read show and configuration	246
Read show components only	247
Read system configuration components only	247
<b>Chapter 21</b>	
<b>Printing</b>	249
Printer options	250
Printing procedure	250
Printouts available	251
Moving lights	251
<b>Chapter 22</b>	
<b>Clear functions</b>	253
Clear functions	254
Clear and reset procedure	254
Clear and reset options	255
<b>Chapter 23</b>	
<b>Dimmer monitoring</b>	257
ETCLink functions	258
Enabling ETCLink	258
Error messages	259
How to enable / disable ETCLink error messages	260
ETCLink displays	261
Dimming system status	261
Dimmer rack status	262
Dimmer status	263
Monitoring dimmers	264
Load Management display	264
Record Loads procedure	265
Load Check procedure	266
Clear Loads procedure	267
Setting and unsetting dimmers	268
Setting a dimmer	268
Unsetting a dimmer	268
Working with Sensor backup looks	269
Recording a backup look	269
Playing a backup look	270

<b>Chapter 24</b>	
<b>Control interfaces</b>	271
MIDI	272
ETC MIDI	272
MIDI Show Control (MSC)	275
Real time programs	280
Go to the Real Time Programs display	280
Enabling / disabling real time programs	281
Creating real time programs	282
Editing real time programs	284
Deleting real time programs	284
Inserting real time programs	284
Copying real time programs	285
Moving real time programs	285
Sorting/recording real time programs	285
Time Code	286
Setting time code frame rate	286
Creating a time code program	287
Sorting/recording events	290
Editing time code programs	290
Re-setting the event list pointer	290
Resetting loop time	291
Deleting time code events	292
Inserting time code events	292
Copying time code events	293
Moving time code events	294
Editing events	295
Running a time code program	297
Remote macros	300
Serial interface	300
Remote trigger	301
<b>Chapter 25</b>	
<b>Accessories</b>	303
Remote Focus Unit (RFU)	304
Alphanumeric keyboard	305
Console lights	306
Expression Off-Line	306
<b>Appendix A</b>	
<b>Installation</b>	307
Console's back panel	308
External device fuse	308
Installing the console and monitor	309
VGA monitor connections	309
Understanding ETCNet	310
Installing interface devices	310
Network wiring	310
Preparing interface devices	310
Connecting dimmers to console	311
Configuring the DMX512 ports	312
Port starting dimmer numbers	312
Setting the port to Dimmer Doubling	313
Setting DMX512 speed	313

Installing an alphanumeric keyboard . . . . .	314
Installing a printer . . . . .	315
Installing Remote Focus Unit . . . . .	315
Installing MIDI . . . . .	316
Installing console lights . . . . .	316
Installing remote macros . . . . .	317
Wiring remote macros . . . . .	318
Upgrading software . . . . .	319
Upgrading a console . . . . .	319
Upgrading remote interface devices . . . . .	319
<b>Appendix B</b>	
<b>References</b> . . . . .	321
Remote Interface devices . . . . .	321
Installing jumpers . . . . .	321
Remote Interface Unit (RIU) . . . . .	321
Remote Video Interface (RVI) . . . . .	323
Installing remote video monitors . . . . .	325
<b>Appendix C</b>	
<b>Error messages</b> . . . . .	327
Diskette error messages . . . . .	327
Other error messages . . . . .	327
ETCLink errors . . . . .	328
Fatal messages . . . . .	328
Secondary Messages . . . . .	329
<b>Appendix D</b>	
<b>Showfile</b> . . . . .	331
Show contents . . . . .	331
Configuration settings . . . . .	332
Read show results . . . . .	332
Read system configuration results . . . . .	332
<b>Appendix E</b>	
<b>Softkeys</b> . . . . .	333
<b>Appendix F</b>	
<b>Time and location</b> . . . . .	341
United States cities . . . . .	341
Cities outside the United States . . . . .	342
<b>Appendix G</b>	
<b>Specifications</b> . . . . .	343
<b>Appendix H</b>	
<b>Declaration of Conformity</b> . . . . .	349
<b>Appendix I</b>	
<b>Limited Warranty</b> . . . . .	351
<b>Index</b> . . . . .	355

# *Chapter 1*

## *Introduction*

This manual covers the installation and operation of lighting systems containing ETC's Express 125 and 250 control consoles operating with version 3.1 system software. The differences between these consoles is shown under [Appendix G Specifications, page 343](#). Throughout the manual, both consoles are referred to as Express unless a distinction is necessary.

Chapter one includes information to orient you to the console and the manual. It includes the following sections:

- Using this manual
- Using Help
- Text conventions
- Navigation and visual feedback
- Output level conventions
- Moving light concepts and terms
- The Only command
- Using the trackpad
- Electronic backup maintenance
- Troubleshooting

## ***Using this manual***

This manual provides instructions for using the console's features and optional accessories.

### ***Setting up the console***

If you are setting up the system for the first time, see [Appendix A Installation, page 307](#), and [Chapter 3 System settings, page 21](#), for information about setting up your system. If the system is already in place, you may not need to refer to these chapters.

### ***New users***

If you are new to lighting systems or to ETC's consoles, read chapters 4 through 13 for instructions about patching conventional lights and moving light fixtures, setting levels and using cues, groups, and submasters. These are the building blocks for creating and running any show. Once you are comfortable with these functions, chapters 16 through 19 provide more advanced information on effects, subroutines, macros and link lists.

## ***Keyboard Help***

Help screens are available for all console keys, including softkeys and wheels. To display help screens, press [Help], then press any key on the console.





## ***Text conventions***

In this manual, console keys and softkeys are indicated by square brackets, such as [Enter] and [S1]. Messages appearing on a console display are printed in boldface, such as **Select channel**. References to other sections of the manual are printed in italics, such as *Chapter 1 Introduction*.

## Navigation and visual feedback

Move through console menus and displays in the ways that work best for you. The console offers alternative navigational techniques and visual feedback that confirms your choices all along the way.

Note how navigation and feedback information is collected in the table below. Tables like this are used throughout this User Manual to help you use console displays. When alternative navigational techniques perform the same function, examples in the text illustrate the technique that many find the most convenient or efficient to use.

Navigation and Feedback - Console menus					
		[S]			
Select a menu item	X		X		X
Highlighted characters	Item selected				

In these Navigation and Feedback tables,



represents the keypad,



represents the softkeys,



represent the up and down keyboard arrows,



represent the right and left keyboard arrows, and



represent the plus and minus keys.

# Output level conventions

The console uses both a highest level, or pile-on, convention and a last action convention to determine levels for channels affected by more than one control. Channels may be defined to operate with either convention.

## HTP channels

The behavior of a pile-on channel is defined by the Highest Takes Precedence (HTP) rule. The console reads all output levels it receives for an HTP channel and sets that channel to the highest of them. A channel controlled by a submaster always obeys the HTP rule, but the Blackout key, Grandmaster control and parked channels all have priority over levels set from the keypad.

For example, if an HTP channel is included in both a submaster and a cue that has played back and is in a fader, the console sets the channel at the higher of the two levels. Or, you may use the keypad to select that channel and set it to any level, regardless of the levels set either by the cue or the submaster.

HTP channels in the console are called “normal” channels.

## LTP Channels

Channels may also be defined in the console to follow the Latest Takes Precedence (LTP) rule. An LTP channel obeys the latest command to set its level. When the command is to fade to a level, an LTP channel can fade either in a physical fader (in the foreground) or in a background fader. Each LTP channel has its own background fader.

An LTP channel fades in the foreground if its level moves to a new level in the next cue. When a channel is fading in the foreground and no change in that channel is commanded by the next cue, the fade continues in the background. A cue stops running in the background when the last of its channels stops fading in the background. Up to 600 cues may run in the background at once.

For example, consider three cues recorded for channels Chan 1, Chan 2 and Chan 3, all of which are set as LTP channels. The cues contain percentage levels for these three channels as follows:

	Chan 1	Chan 2	Chan 3
Cue 1	25	0	0
Cue 2	25	50	0
Cue 3	50	50	50

- When Cue 1 starts, channel Chan 1 starts fading to level 25 with Cue 1 timing.
- If Cue 2 starts before Cue 1 ends, channel Chan 1 continues fading in the background with Cue 1 timing and channel Chan 2 starts fading in the foreground to level 50 with Cue 2 timing.
- If Cue 3 starts before Cue 2 ends, channels Chan 1 and Chan 3 start fading in the foreground to level 50 with Cue 3 timing; channel Chan 2 continues fading in the background with Cue 2 timing.



## Enabling LTP

You can set a channel's status to LTP or HTP as long as the channel is not used in Fixture Patch. If the channel is patched to a fixture, the personality controls the HTP/LTP status. All attributes (channels) are set to LTP by a personality except the intensity attribute. All channels not patched to a fixture default to HTP (considered "normal").

Set channels to HTP or LTP, either singly or in ranges, in the Channel Attributes display using the following procedures.

<b>Keystrokes:</b>	<b>Action:</b>
1. Press [Setup] [1][1] [Enter].	Selects the channel attributes display
2. Press [1] [Thru] [1][0] [Enter].	Specifies channels 1 through 10
3. Press [→] [→] [→] [→].	Move to LTP field
4. Press [1].	Sets channels to LTP

## Working with LTP channels

### Background overrides

Cues running in the background can be stopped, adjusted or otherwise controlled with background overrides.<sup>1</sup> There are five override options, as shown in the table below.

<b>Background Override Operations</b>	
1. <b>Clear Cue(s)</b>	Clears cue levels.
2. <b>Cancel Cue(s)</b>	Stops the fade or effect.
3. <b>Finish Cue(s)</b>	Takes cue channels to their completed levels immediately.
4. <b>Master Cue(s) on X-Wheel</b>	Takes proportional control of cue levels immediately.
5. <b>Alter Rate of Cue(s) on X-Wheel</b>	Adjusts cue timing.

Control background overrides as follows:

<b>Keystrokes:</b>	<b>Action:</b>
1. Press [Stage] [S3], <b>Background Overrides.</b>	Selects the Background Overrides list
2. Press [5] [Enter]. <sup>a</sup>	Specifies cue 5
3. Press [#] [Enter].	Specifies the override operation you want performed

*a. Press [0] in this step to apply an override operation to all cues.*

---

<sup>1</sup> Identify which cue contains a particular channel from the About Channel display, covered under [About Channel, page 60](#).

## ***Effects***

LTP channels may be used to preserve an effect in certain channels regardless of levels in the effect. Also, multiple effects can run simultaneously, and other looks can be provided concurrently with effects.

These features are available in the console when you use LTP channels. When an effect cue is sandwiched between two other cues, LTP channel levels in the effect cue are ignored when determining which control takes precedence. A cue that runs after an effect skips over the previous effect cue to determine what happens to levels. If there is a move in the current cue with respect to the same channel in the cue before the effect, the channel fades in the current cue and is "stolen" from the effect. If no move, the channel continues in the effect.

## ***Blocking cue***

A cue running in the background ends when its last fading channel has finished or a background override ends the cue prematurely. Sometimes, however, you would like to end a background cue prematurely.

The way to do that is to follow the background cue with a blocking cue. A blocking cue does to timing what an allfade cue does to level. As soon as an allfade cue is started, all unused channels are forced to zero. Similarly, when a blocking cue starts, all channels running in background cues are faded to completion in the blocking cue's timing. A blocking cue ends all background cues.

Aside from its initial effect on background cues, the blocking cue runs from that point on just like any other cue, including the possibility that it could be forced to the background itself by the next cue.

# Moving light concepts and terms

## Fixtures

Conventional lights, sometimes called fixtures, are single attribute devices whose intensity can be controlled by a console connected to a dimmer. In this User Manual, however, the term *fixture* is often used to refer to multi-attribute devices such as moving lights to distinguish them from conventional lights. The programming methods in this manual apply to any multi-attribute device controlled by DMX512 as to moving lights.

## Fixture attributes

Every fixture has a set of attributes that you use to control it. For instance, a basic moving light might have only three attributes: intensity, pan and tilt. You control the fixture's brightness by adjusting the level of a DMX512 channel that controls a dimmer assigned to the fixture. Similarly, you control the fixture's horizontal and vertical movements by adjusting the levels of DMX512 channels assigned to the fixture's pan and tilt attributes. This simple fixture would require three channels to fully control it. Other, more complicated fixtures could have additional attributes such as color, focus or gobo, and each additional attribute would require an additional DMX512 channel to control it.

In contrast, a standard ellipsoidal spotlight needs only one DMX512 channel to fully control it, namely the one that controls the dimmer assigned to the spotlight. Only the spotlight's intensity can be controlled by changing the channel level. It has no other attributes.

## Categories

Most attributes can be naturally categorized as affecting the beam, the image, the color or the position. All attributes are initially assigned to one of these four categories or to a fifth one called None. Beam attributes include Intensity, Zoom, Focus, Iris, and Frost. Image attributes include Gobo and F/X. Color attributes include Color, Cyan, Magenta, and Yellow. Position attributes include Pan and Tilt. You can customize the assignment of attributes to categories, including assigning an attribute to multiple categories and assigning as many attributes as you want to a single category.

## Personalities

Every fixture has an electronic personality that describes how it can be controlled. The personality specifies the attributes for the fixture and the order in which these attributes are presented to DMX512 channels. Assigning a personality to a fixture makes channel patching quick and easy. All you need to do is define which console channels and DMX512 addresses are first—the personality directs the rest of the assignment.

Many personalities are included with the console software. Other personalities for leading moving light fixtures on the market are being developed by ETC. As additional personalities become available, these are made available to dealers and placed on the ETC website for downloading. Also available from dealers and at the website is a program called the **Expression Personality Editor** which enables you to create and edit fixture personalities on an IBM-compatible computer. For further information about these options, call ETC Technical Services at 800-775-4382 or visit the ETC website at [www.etcconnect.com](http://www.etcconnect.com).

# The Only command

Only is a particularly powerful console command. Use Only to restrict a selection while programming or creating a look on stage.

## When working with fixtures

Use Only to restrict the selection of fixture attributes by category, such as when you are creating or modifying a cue, submaster, group or focus point. For example, press [S8], **Fixture**, [8] [S4], **Only**, [Position] to place the pan and tilt attributes on the trackpad.

## When updating

Following is a list of things you can select when using Only after the Update command in Stage. If you make selections and change your mind, press [Channel] [0] to reselect all non-zero channels.

- Channels** ..... Example: Press [S4], **Only**, [Channel] [1] [Thru] [5].
- Fixtures** ..... Example: Press [S4], **Only**, [S8], **Fixture**, [1] [And] [2].
- Fixture attributes** ..... Example: Pressing [S8], **Fixture**, [1] [S4], **Only**, [S6], **Attribute**, [6] selects attribute 6 of fixture 1.
- Fixture categories** ..... Example: Pressing [S8], **Fixture**, [1] [S4], **Only**, [Beam] selects all attributes in the Beam category for fixture 1.
- Cues** ..... Example: Pressing [S4], **Only**, [Cue] [5] selects all channels in cue 5 (not for effect cues).
- Submasters** ..... Example: Pressing [S4], **Only**, [Sub] [6] selects all channels in submaster 6 (not for effect submasters).
- Groups** ..... Example: Pressing [S4], **Only**, [Group] [7] selects all channels in Group 7.
- Focus Points** ..... Example: Pressing [S4], **Only**, [Focus Point] [8] selects all channels in Focus Point 8.

## When recalling channels

Use to restrict a selection from among the channels, fixtures and attributes on stage.

The use of Only after the Update command is illustrated with the following examples:

- Press [Group] [1] [S4], **Only**, [Channel] [5] [Thru] [1][0] to select channels in group 1 that lie in the range 5 through 10.
- Press [Group] [1] [S4], **Only**, [Cue] [6] to select channels in Group 1 that are also in cue 6.

## Using the trackpad

Use the Express trackpad to set rates and levels. The trackpad operates in three modes, single mode, double mode, and XY mode, described below. You can also set the trackpad's sensitivity.

<b>Single mode</b>	Most of the time the trackpad is in single mode. If the console prompts you for a rate or a level, moving your finger up on the trackpad increases the rate or level. Moving it down decreases the rate or level.
<b>Double mode</b>	If you use the Link List function to link two or more channels and then select any linked channel, the trackpad automatically switches into double mode. In double mode the trackpad is divided into two regions, The left side controls channels in the X half of the link (colored gold on the display). The right side controls channels in the Y half of the link (colored yellow on the display). Move your finger up or down on either side to control channel levels in the corresponding link.
<b>XY mode</b>	If you use the Link List function to link two or more channels and set the link's position attribute for XY position, then select any linked channel with that attribute, the trackpad automatically switches into XY mode. In XY mode move your finger right or left on the trackpad to control channels in the X half of the link (colored gold on the display). Move your finger up or down to control channels in the Y half of the link (colored yellow on the display).

### **Trackpad notes:**

- If you have channels selected from both kinds of link, the trackpad defaults to double mode.
- In double mode you may only set one side at a time.

### **Sensitivity**

To the left of the trackpad you will find two buttons that control trackpad sensitivity. The top button has a rough texture. Press this to set the trackpad for low sensitivity. The lower button has a smooth texture. Press this to set the trackpad for high sensitivity. Use high sensitivity for precise level or rate adjustments. Use low sensitivity for faster, less precise adjustments.

## ***Electronic backup maintenance***

Information in console memory is preserved by an electronic backup system for approximately 28 days. Within the limits of this system, if power should fail or if you shut down and then re-power, all programmed elements should be the same as they were. For additional security, ETC recommends that you routinely save to diskette as you go along and before shutting down.

**CAUTION:** The electronic backup maintenance system must be recharged periodically to function as intended. You must have the processor on for at least seven hours every 28 days to maintain the necessary charge.

## ***Troubleshooting***

If you have problems using your console, please refer to this manual's index or to the console's Help<sup>2</sup> function for additional information.

If you do not find the answer in the manual, please call your local dealer or ETC Technical Services. Have the following information available before you call:

- Console model and serial number (located on back panel)
- Software version (displayed in the lower right corner of the Setup menu)
- Options installed
- Dimmer installation type
- Dimmer manufacturer

---

<sup>2</sup> See [Keyboard Help, page 2](#).

## ***Help from ETC Technical Services***

If you are having difficulties, your most convenient resources are the references given in the index of this manual and the console Help system, which is explained under [Keyboard Help, page 2](#). To search more widely, try the ETC website at [www.etcconnect.com](http://www.etcconnect.com). If none of these resources are sufficient, contact ETC Technical Services directly at one of the offices identified below. In some cases, calls outside normal business hours are answered electronically and forwarded to a service representative.

When calling for help, please have the following information handy:

- Console model and serial number
- System software version (shown in Setup menu)
- Dimmer manufacturer and installation type

### ***Americas***

ETC Americas  
Technical Services Department  
3030 Laura Lane  
Middleton, WI 53562

800-775-4382  
(608) 831-4116  
[service@etcconnect.com](mailto:service@etcconnect.com)

### ***Europe***

ETC Europe Ltd.  
Technical Services Department  
5 Victoria Industrial Estate  
Victoria Road,  
London W3 6UU England

+44 (0)20 8896 1000  
[service@etceurope.com](mailto:service@etceurope.com)

### ***Asia***

ETC Asia, Ltd.  
Technical Services Department  
Room 605-606  
Tower III, Enterprise Square  
9 Sheung Yuet Road  
Kowloon Bay, Kowloon, Hong Kong

(+852) 2799 1220  
[service@etcasia.com](mailto:service@etcasia.com)





# *Chapter 2*

## *Monitor displays*

Express operates with one color video monitor. This monitor provides information regarding your show, including a cue list, the current status of the console's two fader pairs and a variety of user selectable displays. These displays allow you to create and run shows and to configure your console and your lighting system.

If your system includes ETCNet, additional monitors may be installed at other locations, such as backstage or in the sound booth. These remote monitors show the same displays as the console's monitor. To install remote monitors, see [Installing remote video monitors, page 325](#).

Chapter two includes descriptions of the following displays:

- Stage
- Blind
- Flexichannel
- Patch

## Colors in displays

The colors in which channel numbers and output levels are displayed on screen provide information about the channels. The following list shows the meaning of colors in Stage and Blind displays.

### Channel numbers/Standard patch

**Gray** ..... Unselected channel.  
**White** ..... Channel not selected by Only function.  
**Yellow** ..... Selected channel. Controlled by the level (Y) wheel.

### Channel numbers/Fixture patch

**Gray bar** ..... Surrounds all channels of one fixture.  
**Light gray** ..... Low channels for 16-bit data types.  
**Gold** ..... Channels linked through the link list or fixtures.<sup>3</sup>  
**Yellow** ..... Selected channels of selected fixtures.<sup>3</sup>

### Channel output levels

**White on Red** ..... Channel level when it is being changed.  
**Yellow** ..... In Stage, a channel in yellow was set by a submaster.  
**White** ..... In Stage, a channel in white was set by an effect. In Blind, a channel in white was set by a submaster, group, focus point or an allfade cue.  
**Gray** ..... Channel was recorded into a multipart cue, but not in the currently displayed part (Blind only).  
**Red** ..... In Stage, captured channels are in red. In Blind, channels not recorded are in red.  
**Green** ..... Channel output level is changed from what it was in the previous cue. In Blind only, channel output is lower than it was in the previous cue.  
**Purple** ..... Channel output level is the same as it was in the previous cue (tracking).  
**Blue** ..... In Blind only, channel output level is higher than it was in the previous cue.

### Changing pages

Channels are displayed on several pages in the Stage and Blind displays. Use [S4], **Previous Page**, and [S5], **Next Page**, to switch from page to page. Also, pressing [←] takes you to the first page, pressing [↑] takes you to the previous page (last page if currently on the first page), pressing [↓] takes you to the next page, and pressing [→] takes you to the final page.

---

<sup>3</sup> Only High channels for 16-bit data types.

## ***Display features***

Three of the console displays—Stage, Blind and Patch—share many features, such as a channel display area, command line and softkeys. This chapter's illustrations of these displays are all labeled with these common features, and the explanations are given directly below. If some common features differ slightly for a particular illustration, such as the profile assignment in Patch, that information and other unique information for the display is given with the illustration.

### ***Display name***

Identifies the display shown and the current time.

### ***Keypad corner***

Indicates how the console will interpret the next number entered from the keypad. For example, when the **Keypad corner** displays "Chan" the next number you press will be taken as a channel number. If you enter a range, such as with the [Thru], [And] or [Except] keys, each number is displayed in turn but only the last number in the range remains.

### ***Channel area***

Shows channels, their levels and focus point references, if any, in selected cues, submasters, groups or focus points. Below each channel number is its level, if set. Below each level is the reference to the focus point, if any, used to set the level.

### ***Prompt area***

Shows a prompt or information display related to your next or just-completed action.

### ***Attribute bar***

Shows current settings for the selection, such as a cue, group or submaster.

### ***Softkeys***

Shows additional functions available by pressing console keys [S1] through [S8].

## Stage

The Stage display shows you the current levels of all active channels. Up to 100 channels appear on the display at a time.

The screenshot shows the Stage display interface with the following sections:

- Global settings:** Grandmaster 100%, Sub Page 1, Stage 03:59 PM, Chan, Captured Channels.
- Channel area:** A grid of 100 channels (001-100) with levels and fader status (FL) for various channels.
- Prompt area:** Select channel numbers.
- Fader Status:** Fader A/B Cue 101 Complete 100%, Fader C/D Clear, Cue/Type >101, Time 5, Link Follow Rate.
- Attribute bar:** Cue/Type 101 XF 5, Time 5, Link Follow Rate 103, Cue / Time Code List.
- Softkeys:** 1 Sneak, 2 Update, 3 Backgrnd Overrides, 4 Only, 5 Follow, 6 Park, 7 More Softkeys, 8 Fixture.

### Global settings

Current settings for Grandmaster, Blackout and submaster page.

### Fader Status

Shows current status of both fader pairs, including which cues are running, their fade times, percentage of completion and follow time.

### Cue / Time Code List

Normally, this displays a cue list, but it can be toggled to show a Time Code list. The Cue List shows all cues along with their attributes. The last cue that ran in the faders is highlighted in yellow, and the next cue in sequence is highlighted in white (can be changed from Stage mode, but not from Blind). The Time Code List is a comprehensive listing of all time code events in the show. See [Time Code, page 286](#), for further information.

To toggle between the lists:

1. Press [Setup].
2. Choose **6 - Option Settings** from the Setup menu, then press [Enter].
3. Choose **7 - Display Cue/Time Code List** from the Option Settings menu, then press [Enter].
4. Follow prompt to toggle the display.

### Blind

The Blind display lets you work on cues, groups and submasters without affecting the look on stage. It looks exactly like the Stage display, pictured above, except some of the softkeys are different<sup>4</sup> and it has Blind for the Display Name.

<sup>4</sup> See [Appendix E Softkeys, page 333](#) for a complete tabulation of console softkeys.

## Fader

Express has a special Fader display that allows you to isolate channels in the display according to whether they come from the A/B or C/D fader pairs. You may also separately display channels in background faders.

Enter the Fader display from the Stage display as follows:

1. Press [S7], **More Softkeys**, until **Fader** appears at softkey S4.
2. Press [S4], **Fader**.

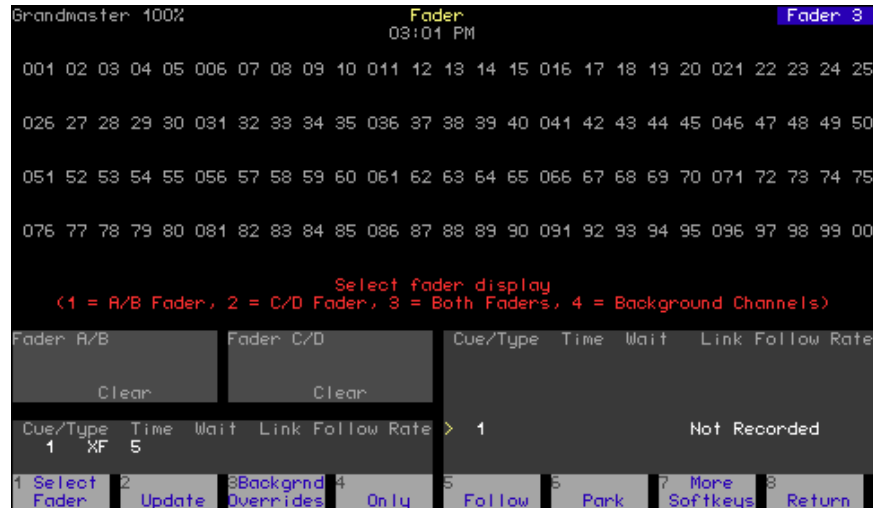

Upon entering the Fader display, you are prompted to select a display from the four options listed below. You can re-select the display at any time by pressing [S1], **Select Fader**.

1. **A/B Fader**
2. **C/D Fader**
3. **Both Faders**
4. **Background Channels**

# Flexichannel

When you enable Flexichannel,<sup>5</sup> only channels used somewhere in the show will appear on the display screens, subject to the following rules:

- Flexichannel displays channels whose levels are set, whether recorded somewhere in the show or not.
- Flexichannel does not display channels whose attributes are changed unless their levels are also set.
- Flexichannel shows the channels for all fixtures patched in the show.
- Flexichannel shows all channels on link lists.
- Flexichannel shows focus point links, if applicable (see focus point links to the right of the levels in the illustration below).

By only displaying channels used in the show, you can reduce the amount of time you spend moving from page to page to find channels. All other screen elements are unchanged.



Working with Flexichannel active differs from working without Flexichannel in only one respect, selecting channels. See [Selecting channels in Flexichannel mode, page 56](#) for more information.

*Note: In Patch mode, channels are highlighted if they appear in the Flexichannel list; they are grayed out if they do not.*

## Updating Flexichannel

When channels that were used in a show are removed from the show, they remain in channel displays until Flexichannel is updated. Press [Setup] [1] [Enter] [S1], **Purge Flexi**, to update Flexichannel. This update follows the same rules for Flexichannel that are given above.

You also update Flexichannel displays when you load another show from diskette or when you cycle the console's power off and on.

---

<sup>5</sup> See [Enable / disable Flexichannel, page 27](#), for information about enabling Flexichannel.

# Patch

The Patch display allows you to create and modify your patch. Patch moving lights in Fixture Patch, covered under [Patching one fixture or a fixture range](#), page 69.

**Display name** **Keypad corner**

Chan	Dimmer/Proportion/Profile
1	1 251 501 751 1001
2	2 252 502 752 1002
3	3 253 503 753 1003
4	4 254 504 754 1004
5	5 255 505 755 1005
6	6 256 506 756 1006

**Patch area** (points to the table)

**Level assigned** (points to '75' in row 3)

**Profile assigned** (points to '74' in row 5)

**Prompt area** (points to the red text: "Select dimmer numbers, then press ENTER to assign to a channel, or press AT to assign a proportion, or press PROFILE to assign a profile")

**Softkeys** (points to the bottom row of buttons: 1, 2, 3, 4, 5, 5 Profile, 7 More Softkeys, 8 Show Labels)

## Patch area

Lists channels in the first column, dimmers patched to channels in the second and subsequent columns, and the levels and/or profiles assigned to those dimmers. In Flexichannel mode, channels that are used are highlighted.

## Profile assigned

Displays the profiles assigned to dimmers.

## Level assigned

Shows the levels assigned to dimmers.





# ***Chapter 3***

## ***System settings***

System settings allow you to customize the console for the number of dimmers and channels in your system, set system modes and screen formats, and choose default settings for a variety of console functions. The following illustration shows default settings.

Chapter three includes the following sections:

- Setting number of dimmers
- Setting number of channels
- Setting default fade times
- Setting default Level
- Setting default fader clear times
- Setting default Sneak time
- Blackout key
- Selecting Flexichannel mode
- Master Type
- Set Channels / Submasters 1-to-1
- Record Lockout
- Bump keys
- Setting the clock
- About Show

## Setting the number of dimmers

Your console is set by default to provide 1,024 DMX512 outputs from its 2 DMX512 ports, where each port provides up to 512 DMX512 outputs. All DMX512 outputs are represented in the Patch display as dimmers. You may reduce the dimmer count to save clutter in the Patch display, but many prefer to leave the dimmer count at the default setting.

If you decide to reduce the dimmer count, you need to take into consideration a number of factors, including how many dimmers are actually in your system, whether you are doubling dimmers and whether you are patching moving lights. The following three rules can help you determine a comfortable dimmer count on a port-by-port basis to arrive at an optimal setting for your circumstances.

1. If the port is doubled, make allowance for the B-components of doubled dimmers that start at DMX512 address 257. ETC recommends that you use the full capacity when a port is doubled.
2. If a moving light is patched to a port, make allowance for all the channels in the fixture's personality even when no external dimmer is required. For instance, a Cyberlight contains its own dimmer and needs 20 channels to control all the fixture's attributes, so 20 DMX512 outputs are required. When one or more moving lights are patched to a port, you can either total the channels needed for all moving and conventional lights on that port, or you can play it safe and use the port's full capacity.
3. If the port is neither doubled nor used for moving lights, the port's dimmer count can be the actual number of dimmers connected to it.

Example: Suppose you have 96 dimmers connected to each of your 2 ports, with port 1 doubled and port 2 used for moving lights. An optimal dimmer setting would be unchanged from the default at 1,024 dimmers (512+512).

If you increase the number of dimmers, the additional dimmers are initially patched to channel zero. From there, you can assign them to the channel of your choice.

Follow these steps to set the dimmer count for your console:

<b>Keystrokes:</b>	<b>Action:</b>
1. Press [Setup].	Selects Setup display
2. Select [1], <b>System Settings</b> , and press [Enter].	Selects System Settings menu
3. Select [1], <b>Number of Dimmers</b> , and press [Enter].	Prompt reads: <b>Select number of dimmers, then press ENTER</b> <b>(Note: Fixtures require one dimmer for every control channel)</b>
4. Press [8][0][0] to enter the desired number of dimmers.	Corner reads: <b>Dim 800</b>
5. Press [Enter].	Number of dimmers is set to 800

## Setting the number of channels

You may find that in some circumstances you don't need all the channels available in your console. The system default is the maximum number of channels the console can address. By reducing the channel count below this maximum, you can significantly reduce processing time and free console memory for other purposes.

If you plan to reduce the number of channels, note that when patching fixtures you need one channel for every attribute in a fixture's personality (two channels for each 16-bit attribute). For example, a fixture's personality might require the assignment of 20 channels for the mix of attributes and data types used by that fixture. If you patched five of those fixtures, your console would need to provide 100 channels.

Follow these steps to set the channel count for your console:

<b>Keystrokes:</b>	<b>Action:</b>
1. Press [Setup].	Selects Setup display
2. Select [1], <b>System Settings</b> , and press [Enter].	Selects System Settings menu
3. Select [2], <b>Number of Channels</b> , and press [Enter].	Prompt reads: <b>Select number of channels, then press ENTER</b> <b>Note: Fixtures require one channel for every control output)</b>
4. Press [1][0][0] to enter the desired number of channels.	Corner reads: <b>Chan 100</b>
5. Press [Enter].	Number of channels is set to 100

## Setting default fade times

The console assumes default values for upfade and downfade times, but you can change them. Change all fade times at once by changing the default values, as explained below. You can also change fade times individually as explained under [Recording a cue with a single fade time, page 85](#), and also under [Recording a cue with split fade times, page 86](#).<sup>6</sup>

Fade times may be programmed from 0.1 seconds to 99:59 minutes. The number may be entered in normal time format or in decimal format. When entered with a decimal point, the number must be less than one minute (0.1 to 59.9 seconds) to be accepted. When entered without a decimal point, a 2-digit number will be treated as seconds if less than 60 and as a calculated value of minutes and seconds if between 60 and 99. For example, if you enter 70, the time will display as 1:10. If you enter either a 3-digit or a 4-digit number, the last two digits, up to 59, are interpreted as seconds. For example, if you enter 9930, the time will display as 99:30.

Follow these steps to assign new default fade times.

<b>Keystrokes:</b>	<b>Action:</b>
1. Press [Setup].	Selects Setup display
2. Select [1], <b>System Settings</b> , and press [Enter].	Selects System Settings menu
3. Select [3], <b>Default Fade Time</b> , and press [Enter].	Prompt reads: <b>Enter default up fadetime</b>
4. Press [6] to enter a six second upfade time.	Corner reads: <b>UpTime 6</b>
5. Press [Enter].	Prompt reads: <b>Enter default down fadetime</b>
6. Press [3] to enter a three second downfade time. <sup>a</sup>	Corner reads: <b>DnTime 3</b>
7. Press [Enter].	Fade times are reset

*a. If you want the upfade and downfade times to be the same, skip steps 6 and 7. The downfade would take whatever value you assigned to the upfade time in step 4.*

---

<sup>6.</sup> The factory-set default fade time is five seconds.

## Setting default Level key

The console allows you to assign a value to the [Level] key. The default value is 100 percent. You may assign [Level] any value between zero and 100.

Follow these steps to assign a value to [Level]:

<b>Keystrokes:</b>	<b>Action:</b>
1. Press [Setup].	Selects Setup display
2. Select [1], <b>System Settings</b> , and press [Enter].	Selects System Settings menu
3. Select [4], <b>Default Level</b> , and press [Enter].	Prompt reads: <b>Enter default level (Press FULL button for 100%)</b>
4. Use the keypad to enter the two-digit number (00-99). <sup>a</sup>	New default for [Level] is set

*a. To enter a level between one and nine percent, you must precede the number with a zero. You may also press [Level] or [Full] for the assignment.*

## Setting default fader clear time

The default fader clear time determines the fade time for both [Clear] keys. Pressing the [Clear] key above one of the fader pairs clears the cue from the fader, fading all channels in that fader to zero. Channels black out immediately when clear time is zero.

Fader clear times can be programmed from 0.1 second to 99:59 minutes. See [Setting default fade times, page 24](#), for information about entering the time value.

Follow these steps to set a new default fade time.<sup>7</sup>

<b>Keystrokes:</b>	<b>Action:</b>
1. Press [Setup].	Selects Setup display
2. Select [1], <b>System Settings</b> , and press [Enter].	Selects System Settings menu
3. Select [5], <b>Default Fader Clear Time</b> , and press [Enter].	Prompt reads: <b>Enter default fader clear time</b>
4. Press [9] to enter the time value you wish to assign.	Corner reads: <b>Time 9</b>
5. Press [Enter].	New default time is set to nine seconds

---

<sup>7.</sup> *The factory-set default fader clear time is zero seconds.*

## Setting default sneak time

The sneak function allows you to fade or restore channel levels on stage in a specified time.

The console allows you to assign a default Sneak time.<sup>8</sup> For more information about the Sneak function, see [page 58](#).

Follow these steps to set a new Sneak time:

<b>Keystrokes:</b>	<b>Action:</b>
1. Press [Setup].	Selects Setup display
2. Select [1], <b>System Settings</b> , and press [Enter].	Selects System Settings menu
3. Select [6], <b>Default Sneak Time</b> , and press [Enter].	Prompt reads: <b>Enter default sneak time</b>
4. Enter the time you wish to assign as the Sneak time and press [Enter].	Sets the new default Sneak time

---

<sup>8.</sup> The factory-set default sneak time is five seconds.

## ***Enable / disable Blackout key***

The console's [Blackout] key may be enabled or disabled. The default condition is enabled.

Follow these steps to enable or disable [Blackout]:

<b>Keystrokes:</b>	<b>Action:</b>
1. Press [Setup].	Selects Setup display
2. Select [1], <b>System Settings</b> , and press [Enter].	Selects System Settings menu
3. Select [8], <b>Blackout Key</b> , and press [Enter].	Prompt reads: <b>Enable/disable blackout key (1 = Enable, 0 = Disable)</b>
4. Press [1] or [0].	Corner reads: <b>Black 1</b> Or... <b>Black 0</b>
5. Press [Enter].	[Blackout] is enabled or disabled

## ***Enable / disable Flexichannel***

The console's Command display can be set to operate in full display mode or in Flexichannel mode. In full display mode, channel displays show all channels and their current status. In Flexichannel mode, only channels with a recorded level or that are on the Link List appear. The console defaults to full channel display.

Follow these steps to enable or disable Flexichannel:

<b>Keystrokes:</b>	<b>Action:</b>
1. Press [Setup].	Selects Setup display
2. Select [1], <b>System Settings</b> , and press [Enter].	Selects System Settings menu
3. Select [9], <b>Flexichannel</b> , and press [Enter].	Prompt reads: <b>Enable/disable flexichannel (1 = Enable, 0 = Disable)</b>
4. Press [1] or [0].	Corner reads: <b>Flexi 1</b> Or... <b>Flexi 0</b>
5. Press [Enter].	Flexichannel mode is enabled or disabled

## Set grandmaster type

You may set the Master slider to one of three control options.

- **Disabled** Master slider does nothing.
- **Grandmaster** Master slider controls all levels on stage except parked channels and independent channels.
- **Sub Grandmaster** Master slider controls all levels on stage set by submasters.

To configure your Grandmaster, follow these steps:

Keystrokes:	Action:
1. Press [Setup].	Displays Setup menu
2. Press [1], <b>System Settings</b> , [Enter].	Displays System Settings menu
3. Press [1][0], <b>Master Type</b> , [Enter].	Prompt reads: <b>Select master type and press ENTER (0 = Disabled, 1 = Grandmaster, 2 = Sub Grandmaster)</b>
4. Press [1] [Enter].	Master is set as Grandmaster

## Set channels / submasters 1-to-1

Set Channels / Submasters 1-to-1 sets your console's channels to a one-to-one match with your submasters. Thus, channel 1 is patched to submaster 1, channel 2 to submaster 2, and so on. Channel levels are set to Full and up/dwell/down times are set to 0/Manual/0.

To reset your channels and submasters, follow these steps:

Keystrokes:	Action:
1. Press [Setup].	Displays Setup menu
2. Press [1], <b>System Settings</b> , [Enter].	Displays System Settings menu
3. Press [1][1], <b>Set Channels/ Submasters 1-to-1</b> , [Enter].	Prompt reads: <b>Select page to default, then press ENTER (0 = All pages)</b>
4. Press [Enter].	Channels are assigned to submasters. The display returns to Setup menu



## Record lockout

You may set the console to disable the Record function. This protects a finished show from inadvertent changes.<sup>9</sup>

To disable the Record function in your system, follow these steps:

<b>Keystrokes:</b>	<b>Action:</b>
1. Press [Setup].	Selects Setup display
2. Press [1], <b>System Settings</b> , [Enter].	Selects System Settings menu. Menu indicates current status of Record Lockout
3. Press [1][3], <b>Record Lockout</b> , [Enter].	Prompt reads: <b>Enable/Disable record lockout (1 = Enable, 0 = Disable)</b>
4. Press [1] to lock out the record function.	Record is locked out. If you attempt to record anything, the prompt reads: <b>Record is locked out (Press CLEAR to continue)</b>

## Enable / disable bump buttons

The console's submaster bump buttons (also known as bump keys) may be enabled or disabled. The default condition is enabled.

Follow these steps to enable or disable all submaster bump buttons:

<b>Keystrokes:</b>	<b>Action:</b>
1. Press [Setup].	Selects Setup display
2. Select [1], <b>System Settings</b> , and press [Enter].	Selects System Settings menu
3. Select [1][4], <b>Bump keys</b> , and press [Enter].	Prompt reads: <b>Enable/disable bump keys (1 = Enable, 0 = Disable)</b>
4. Press [1] or [0].	Corner reads: <b>BpStat 1</b> Or... <b>BpStat 0</b>
5. Press [Enter].	Submaster bump buttons are enabled or disabled

---

<sup>9</sup> As always, the best way to safeguard your show is to make backups. See [Chapter 20 Diskette functions, page 243](#), for instructions on backing up a show to diskette.

## Setting the clock

The console clock is called a real time clock because it is set with respect to the true time for your location, not a relative time such as would exist for a time code signal. The console's real time clock also functions as an astronomical clock, which means that you can set it for the latitude, longitude and time zone at your location and thereby control real time programs with respect to sunrise or sunset. Astronomical data for many cities in the world is given in [Appendix F Time and location, page 341](#).<sup>10</sup>

### Clock functions display

Before running real time programs you must set the clock. The six options available to set the clock are shown in the Clock Functions display. Go to the Clock Functions display as follows.

Keystrokes:	Action:
1. Press [Setup].	Selects Setup display
2. Press [1][4] [Enter].	Selects Clock Functions menu



Set the clock functions using one or more of the procedures below.

---

<sup>10</sup>. See [Setting the clock, page 30](#), to set the Real Time Clock.

## ***Daylight Savings Time***

### **Keystrokes:**

1. Press [1] [Enter].
2. Press [1] [Enter].

### **Action:**

Prompt reads:  
**Select Daylight Savings Time  
(1 = daylight time,  
0 = standard time)**

Enables Daylight Savings Time.<sup>a</sup>

- a. The clock does not automatically adjust for changes between daylight and standard times. These must be re-set manually.*

## ***Set time/date***

In the following procedure, press [Enter] to scroll through the fields on the screen.

### **Keystrokes:**

Press [2] [Enter].

### **Action:**

Prompt reads:  
**Enter current standard time (12  
hour clock). (To start clock, press  
[Record] - to cancel, press [Clear]**

- Enter the current time in hours and minutes. (In 24- hour format, 930 = 9:30 AM, 1625 = 4:25 PM) (In 12-hour format, use [+] to select AM or PM. Press [Enter].
- Enter the day of the month (1-31). Press [Enter].
- Enter the month (1-12). Press [Enter].
- Enter the year (00-99). Press [Enter].
- Enter the day of the week (1= Monday thru 7= Sunday). Press [Enter].
- Press [Record] to reset Real Time Clock with the new settings.

## ***12/24 hour clock***

### **Keystrokes:**

1. Press [3] [Enter].
2. Press [0] [Enter].

### **Action:**

Prompt reads:  
**Enter 12 or 24 hour clock  
(0 = 12 hour, 1 = 24 hour)**

Sets 12 hour clock.

## ***Latitude, longitude, time zone***

Choose the latitude, longitude and time reference data from **Appendix E** for the city closest to you. The example below is for Middleton, Wisconsin at 43° 04' N latitude, 89° 23' W longitude and 6 time zones west of Greenwich, England.

### **Keystrokes:**

1. Press [4] [Enter].
2. Press [4][3][+] [Enter].<sup>a</sup>
3. Press [0][4][Enter].
4. Press [5] [Enter].
5. Press [8][9][+] [Enter].
6. Press [2][3][Enter].
7. Press [6] [Enter].
8. Press [6][0][0][+] [Enter].<sup>b</sup>

### **Action:**

Prompt reads: **Enter latitude in degrees, then press + for North, or press – for South**

Enters 43 degrees North

Prompt reads:

**Enter minutes of latitude**

Enters 4 minutes.

Prompt reads:

**Enter longitude in degrees, then press + for West, or press – for East**

Enters 89 degrees West.

Prompt reads:

**Enter minutes of longitude**

Enters 23 minutes.

Prompt reads:

**Enter time offset from Greenwich Mean Time in hours/minutes, then press + for West, or press – for East**

Enters 6 hours West.

*a. The + used in this step and the others in this procedure may be optional. Latitude defaults to North, longitude defaults to West and time zone defaults to West.*

*b. Three digits are used for time zones to allow for fractional zones.*

## About Show

About Show provides you with information about the currently loaded show. It tells you how many channels and dimmers your show is configured for and your utilization of recordable entities such as cues, submasters, groups, focus points, macros and time code events. This is important because not enough memory is available to store the maximum number of all recordable entities at the same time.

Use About Show to monitor your memory usage as the complexity of your show increases. If you fill the available memory, reclaim some of it by clearing recorded entities that you are no longer using, for example by reducing how many channels and dimmers are patched.

Press [About] [Enter] to go to the **About Show** display.



The screenshot shows a terminal window titled "About: Show" with the following content:

```
Label: MyShow
Number of channels: 240
Number of dimmers: 1024

Recorded    % Memory    Remaining
Cues:       4           1%         596
Subs:       3/3         1%         21/237
Groups:     3           0%         497
Focus Points: 2           0%         97
Macros:     0           0%         2000
Time Code:  0           0%         3000
System setup: -           34%         -

Memory left: 64%
```

- **Label** Your show's name. The show may be named with Expression Off-Line. See [Expression Off-Line, page 306](#).
- **Number of channels** Shows the value set in the System Settings menu. See [Setting the number of channels, page 23](#).
- **Number of dimmers** Shows the value set in the System Settings menu. See [Setting the number of dimmers, page 22](#).
- **Recorded** Shows how many of each item in the first column that have been recorded.
- **% Memory** Shows what percentage of console memory is consumed for each item in the Recorded column.
- **Remaining** Shows how many more of each item in the first column may be recorded before reaching the console maximum.
- **System setup** Shows how much console memory is used for your setup and configuration settings.
- **Memory left** Shows what percentage of console memory is remaining for your show.



# Chapter 4

## Patching channels

Before you begin creating cues for a show you should first create your patch. The patch assigns individual dimmers to control channel numbers. The console's Patch display allows you to assign any of the dimmers available to any of the control channels your console can address.

You can use the console's default one-to-one patch, or you may create a custom patch. In addition, the console's proportional patching capability allows you to set dimmer output levels and assign one of 33 output profiles to dimmers.

If you are patching dimmers in a Strand CD80 dimmer rack, see [page 49](#) for special instructions.

Before patching, make certain that your dimmer and channel settings are the way you want them. See [Setting the number of dimmers, page 22](#), and [Setting the number of channels, page 23](#), for information on setting the dimmer and channel counts. Setting these counts configures the Patch display for your specific needs and, when channel count is reduced, reduces memory utilization and speeds processing.

Chapter four includes the following sections:

- Selecting one-to-one patch
- Creating custom patch
- Proportional patching
- Labeling dimmers
- Assigning a profile to a dimmer
- Capturing channels in patch
- Dimmer check
- About Dimmer
- Setting dimmers to dimmer doubling
- Patching to a Strand CD80 dimmer rack

## Selecting one-to-one patch

The one-to-one patch assigns dimmer 1 to channel 1, dimmer 2 to channel 2 and so on. If there are more dimmers than channels, the one-to-one patch assigns the first extra dimmer to channel 1, the second extra dimmer to channel 2, and so on.

**NOTE:** Selecting the one-to-one patch unpatches all moving light fixtures.

Follow these steps to select the console's default one-to-one patch.

<b>Keystrokes:</b>	<b>Action:</b>
1. Press [Setup] to display the Setup menu.	Selects Setup display
2. Press [4], <b>Clear Functions</b> [Enter].	Prompt reads: <b>Select function number, then press ENTER</b>
3. Press [9], <b>Reset Patch 1 to 1</b> [Enter].	Prompt reads: <b>To reset patch, press ENTER</b> <b>To cancel, press CLEAR</b>
4. Press [Enter] to confirm your selection of one-to-one default patch, or press [Clear] to cancel the operation.	Sets patch to default one-to-one patch



## Creating a custom patch

The console's custom patching capability allows you to create virtually any dimmer to channel configuration you like. (Groups of dimmers may be assigned to single channels, but only one channel may be patched to a dimmer.)

*Hint: If you use the same patch for several shows, create the patch, and record it on a disk before you record any cues. Label the disk **Standard patch**. When you start your next show, read the Standard patch show into the console, then begin writing cues to avoid reentering the patch.*

Follow these steps to patch dimmers to control channels.

<b>Keystrokes:</b>	<b>Action:</b>
1. Press [Patch].	Selects Patch display
2. Press [Dim]. (If the LED in the [Dim] key is lit, you may omit this step.)	
3. Use the keypad to enter the numbers of the dimmers you want to patch. Use [And], [Thru] or [Except] for multiple selections. <sup>a</sup>	Prompt reads: <b>Select dimmer numbers, then press ENTER to assign to a channel, or press AT to assign a proportion, or press PROFILE to assign a profile</b>
4. Press [Enter] or [Channel].	Prompt reads: <b>To assign dimmers, select channel number, then press ENTER</b> <b>To delete dimmers, press UNPATCH</b>
5. Enter the channel number to which you want to patch the selected dimmers and press [Enter].	Dimmer(s) are patched to the channel
6. Repeat steps 2 through 4 to patch additional dimmers.	

a. For a dimmer set to Dimmer Double, press [S2], **A**, or [S3], **B**, after entering the dimmer number. If you select a doubled dimmer without specifying A or B, the selection defaults to A.

## Proportional patching

Normally, dimmers output with a linear profile at 100 percent unless you scale them to a lower level.<sup>11</sup> The console allows you to proportionally scale the output of an individual dimmer in the Patch display.<sup>12</sup> For example, if you enter a dimmer proportional level of 60 in Patch and set that channel to full in a cue or submaster, the dimmer will output at 60 percent.

Follow these steps to assign a proportional dimmer output level:<sup>13</sup>

- | Keystrokes:  | Action:  |
|--|--|
| 1. Press [Patch].  | Selects Patch display  |
| 2. If the [Dim] LED is unlit, press [Dim] to indicate that the next number entered will be a dimmer.   | Prompt reads:<br><b>Select dimmer numbers, then press ENTER to assign to a channel, or press AT to assign a proportion, or press PROFILE to assign a profile</b> |
| 3. Use the keypad to enter the desired dimmer number(s). Use [And], [Thru] or [Except] for multiple selections. <sup>a</sup>   |  |
| 4. Press [At]  | Prompt reads:<br><b>Select dimmer proportion</b>   |
| 5. Use the keypad to enter the desired maximum output level for the dimmer(s). Full is displayed until a new level is entered. Enter a zero before single-digit levels (i.e., <b>08</b> ). | Dimmer's proportional level is set   |
- a. *If a dimmer is doubled (see [Setting dimmers to Dimmer Doubling, page 48](#), for an explanation) Use [S2], **A**, and [S3], **B**, along with the numeric keypad, to enter dimmer numbers as you create your patch. If you select a doubled dimmer without specifying **A** or **B**, the system defaults to **A**.*

---

<sup>11</sup>. See [Dimmer profiles, page 40](#), to alter a dimmer's profile. The profile takes effect after the dimmer proportion, if any, is first applied.

<sup>12</sup>. Available only for 8-bit channels—applying dimmer scaling to 16-bit channels will yield unexpected results.

<sup>13</sup>. Note: If the dimmer's level is highlighted (white on red), you may use [+] and [-] to adjust the level. Press [Enter] to record the edited level.

## Unpatching individual dimmers

When you unpatch dimmers, they are assigned to channel zero. Channel zero functions as a holding area in which you may store dimmers not included in your patch. It is not an actual control channel.

Before you begin creating a custom patch, you may find it helpful to assign all dimmers to channel zero. Then when you begin patching, you can select dimmers from channel zero and patch them to channels as you like.

Dimmers assigned to channel zero are listed at the end of the channel list in the Patch display as "--." These dimmers are not assigned to any channel but remain on the patch screen.

Follow these steps to assign dimmers to channel zero.

Keystrokes:	Action:
1. Press [Patch].	Selects Patch display
2. If the [Dim] LED is unlit, press [Dim] to indicate that the next number entered will be a dimmer.	Prompt reads: <b>Select dimmer numbers, then press ENTER to assign to a channel, or press AT to assign a level, or press PROFILE to assign a profile</b>
3. Use the keypad to enter the desired dimmer number(s) Use [And], [Thru] or [Except] for multiple selections.	
4. Press [S6], <b>Unpatch</b> .	Selected dimmers are unpatched and assigned to channel zero (- -)

## Show labels

Express allows you to show or hide labels assigned to dimmers.<sup>14</sup> Hiding labels provides additional space in the Patch display to show additional dimmers. In the Patch display, press [S8], **Show/Hide Labels**, to toggle between these two conditions.

---

<sup>14</sup> *Labeling for Express can be done in Expression Off-Line. See [Expression Off-Line, page 306](#).*

## ***Dimmer profiles***

A dimmer profile is a variable level sent to a dimmer during a fade that is related in some way to the percentage of fade completion. By varying the dimmer profile, you can compensate for nonlinear characteristics or other time-dependent variations in lighting instruments as well as warm filaments more slowly to increase lamp life. Dimmer profiles are not available for 16-bit channels, only for 8-bit channels.

A dimmer may have both a proportional level assigned to it as well as a dimmer profile.<sup>15</sup> In the control sequence for a particular channel, the channel's level is first modified by the dimmer scaling, if different from 100%. Then the resulting dimmer level is modified during the channel's fade by the dimmer profile, if different from a linear profile, to yield the dimmer's final output.

The console has 33 dimmer profiles, of which 32 are editable. Profile 0, the default profile, is a linear profile<sup>16</sup> and is not editable. Profiles 1 through 9 have preset, nonlinear profiles and are all editable. Profiles 10 through 32 default to linear profiles and are all editable.

### ***Pre-defined profiles***

- 0 - Linear (not editable)
- 1 - IES square
- 2 - Slow bottom
- 3 - Fast bottom
- 4 - Slow top
- 5 - Fast top
- 6 - Full at 1%
- 7 - Preheat at 5%
- 8 - Preheat at 10%
- 9 - Hot patch

---

<sup>15.</sup> See [Proportional patching, page 38](#), for information about how to make the dimmer output proportional to a scaling factor.

<sup>16.</sup> A linear profile is one that has an intensity level directly proportional to the fade time at all points in the fade time. Thus, when the fade is 50% complete, the intensity level is 50% of the full value.

## Assigning a profile to a dimmer

You may assign one of the 32 alternative profiles to a dimmer. If you assign none, the console sets the dimmer to default profile 0, the uneditable linear profile. Following is the procedure for assigning a profile to a dimmer.<sup>17</sup>

### Keystrokes:

1. Press [Patch].<sup>a</sup>
2. Enter the number of the dimmer to assign on the keypad.
3. Press [S7], **More Softkeys**, [S6], **Profile**.
4. Enter the number of the desired profile.
5. Press [Enter].

### Action:

Prompt reads:

**Select dimmer numbers, then press [Enter] to assign to a channel, or press [At] to assign a proportion, or press Profile to assign a profile**

Prompt reads:

**Select dimmer profile number**

*a. Press [Dim] if the dimmer LED is not lit.*

## Profiles display

Press [Setup] [1][0], **Profiles**, [Enter] to go to the Profiles display.

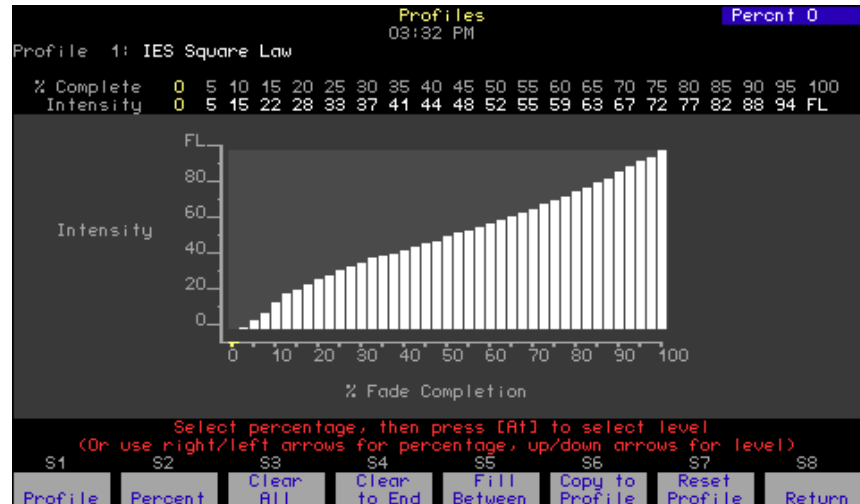



The Profiles display contains a bar chart, with the total time for completion of the fade broken down into 40 equally spaced bars. The height of each bar represents the percentage of the full fade level defined as intensity. Twenty of these bars are editable for intensity and are called fade points. In between the 20 editable fade points are the remaining 20 bars, and these indicate the calculated intensity levels between fade points.

<sup>17</sup>. See [Proportional patching, page 38](#), if you want to use this procedure to assign a proportional level to the dimmer.

Also, the Profiles display contains the following information:

- The profile's number and name (if labeled - see **Labeling Profiles** below).
- For each fade point, the percent of the fade complete at that point. Each fade point contributes 5% to the total fade.
- For each fade point, the intensity at that point.

Navigation and Feedback - Profiles display					
		[S]			±
Select a fade point	X	X		X	
Change the intensity	X		X		X
Yellow numbers	Fade point percentage and intensity values				
Yellow bar	Fade percent point selected				

**Note:** Use [At] to set the level with the keyboard or use [At] [+] or [At] [-] to bump the level by one.

### Creating or editing a profile

If you need a profile that is different from any of the ten provided, you can either edit one of those that already exists (but not default profile 0) or create a new one. As you edit, the profile changes to display the results.

Edit intensities in the Profiles display as follows:

- | Keystrokes:  | Action:   |
|--|---|
| 1. Press [S1], <b>Profile</b> , [1][2] [Enter].                | Selects profile 12<br>Prompt reads:<br><b>Select percentage, then press [At] to select level (Or, use right/left arrows for percentage, up/down arrows for level)</b> |
| 2. Press [S2], <b>Percent</b> , and enter a fade point number. | Selects a fade point  |
| 3. Enter a new intensity on the keypad.                        | Selects an intensity for the face point   |
| 4. Press [Enter] if finished or go back to step 2.             |   |

### Copying to another profile

One convenient way to create a new profile is to copy one of the existing ones to a new profile number and edit the new one. Use softkey [S6], **Copy to Profile**, in the Profile display to copy a profile.

## **Clear All**

For a selected profile, Clear All changes the intensity of all fade points to undefined.<sup>18</sup>

## **Clear to End**

For a selected profile, the Clear to End command sets as undefined the intensity of all those fade points above the selected one.<sup>18</sup>

## **Fill Between**

When intensities in a profile are undefined, such as when you use Clear All or Clear To End, you can use Fill Between to have them automatically filled in with a linear profile. For Fill Between to work, you must have defined intensities on both sides of an undefined range (zero intensity is a defined value). Here is how Fill Between can be used to fill in undefined intensities throughout a particular range.

<b>Keystrokes</b>	<b>Action</b>
1. Press [S1], <b>Profile</b> , [1][5]	Selects profile 15.
2. Press [S2], <b>Percent</b> , [5][0]	Selects the 50% fade point.
3. Press [S4], <b>Clear to End</b> , [Enter]	Changes all fade points above 50% to undefined.
4. Press [S2], <b>Percent</b> , [7][5]	Selects the 75% fade point.
5. Press [At] [1][0]	Sets the 75% fade point to intensity 10
6. Press [S5], <b>Fill Between</b> , [Enter]	Fills between the 50% and 75% fade points with a straight line. Fade points above 75% are unaffected.
7. Finish profile to end.	Set inattentiveness of fade points between 75% and 100%

## **Resetting a profile**

Press [S7], **Reset**, eliminates all editing performed on a selected profile.<sup>19</sup> When profiles 1-9 are reset, the original relationships shown under *Pre-defined profiles, page 40*, are restored. When profiles 10 through 32 are reset, they return to linear relationships.

---

<sup>18.</sup> Undefined intensities are marked \*\* on the Intensity line.

<sup>19.</sup> You may reset all profiles at once by selecting Clear Profiles from the Clear Functions menu.

## ***Captured channels in Patch***

The console lets you select and capture channels without returning to Stage mode. This allows you to bring channels up on stage to view the proportional settings of dimmers assigned to a channel while you set them.

To select channels from the patch screen, follow these steps:

<b>Keystrokes:</b>	<b>Action:</b>
1. Press [Patch].	Selects Patch display
2. Press [Channel].	Prompt reads: <b>Select channel numbers</b>
3. Use the keypad to enter the desired channel number(s) Use [And] and [Thru] if you want to select more than one channel.	Prompt reads: <b>Select channel numbers</b>
4. Press [Full] to set channel level at 100 percent, [Level] to set channel at the default level, or press [At] and enter a level setting.	Selected channels are set at the indicated level
5. Press [Rel] to release channel(s).	



## Dimmer check

The console's dimmer check allows you to raise unpatched dimmers to a specified level on stage, one at a time.<sup>20</sup> Select the starting dimmer, set it at a level and then use [+] to check consecutive dimmers. You may do a dimmer check in any display except Patch and Park.

Perform a dimmer check with the following procedure.

- | <b>Keystrokes:</b>  | <b>Actions:</b>   |
|---|---|
| 1. Press [Dim].   | Prompt reads:<br><b>Enter dimmer number(s), then press AT to select level</b>   |
| 2. Press [1] to start dimmer check with dimmer 1.   | Keypad corner reads:<br><b>Dim 1</b>  |
| 3. Press [At].  | Prompt reads:<br><b>Select dimmer level (Press FULL button for 100%)</b>  |
| 4. Press [7][5] to set the dimmer's level at 75 percent. You may also press [Full] or [Level] to set the dimmer at 100 percent or at the [Level] setting. | Prompt reads:<br><b>To unpatch dimmer for dimmer check, press ENTER</b>   |
| 5. Press [Enter].   | Dimmer 1 is set at 75 percent<br>Dimmer Check window appears<br>Prompt reads:<br><b>Press [+] or [-] to step through dimmers. Press [Clear] to cancel dimmer check.</b> |
| 6. Press [+] to select dimmer 2. Repeat as necessary. Press [Clear] to end dimmer check. <sup>a</sup>   | Dimmer 1 returns to zero, dimmer 2 is set at 75 percent   |
- a. If the dimmer is doubled, the dimmer check is performed on dimmer A of the doubled dimmer first. Pressing [+] moves to dimmer B of the doubled dimmer.*

---

<sup>20.</sup> *If a dimmer is parked, the Dimmer Check window displays a "Parked" message and shows the level at which it is parked. The Dimmer Check does not change a parked dimmer's level on stage.*

# About Dimmer

The About Dimmer display tells you about the characteristics, patch and use of individual dimmers. For the contents of the About Dimmer display when using ETCLink, see [About Dimmer with ETCLink, page 47](#). For similar information about channels, see [About Channel, page 60](#).

Go to the About Dimmer display as follows.<sup>21</sup>

Keystrokes:	Action:
1. Press [About] [Dim].	Prompt reads: <b>About: Select dimmer number, then press ENTER</b>
2. Press [3].	Keypad corner reads: <b>Dim 3</b>
3. Press [Enter].	About Dimmer window is displayed



- **Label** The dimmer's label, if any.<sup>22</sup>
- **Channel** The channel to which the dimmer is assigned.
- **Proportion** The dimmer's assigned proportional level.
- **Profile** The dimmer profile's number and name, if assigned.<sup>22</sup>
- **Console dimmer level** The output level the console currently is sending to the dimmer.
- **Parked** Whether or not the dimmer is parked.
- **DMX512 Port** Port number / address on the port.

---

<sup>21.</sup> Press [Clear] to remove the About window.

<sup>22.</sup> You can assign labels in Expression Off-Line. See [Expression Off-Line, page 306](#).

## About Dimmer with ETCLink

If your console uses ETCLink to monitor dimmers in an ETC Sensor dimming system, the About Dimmer window displays additional dimmer monitoring information. The following expanded About Dimmer window appears if dimmer monitoring is enabled.

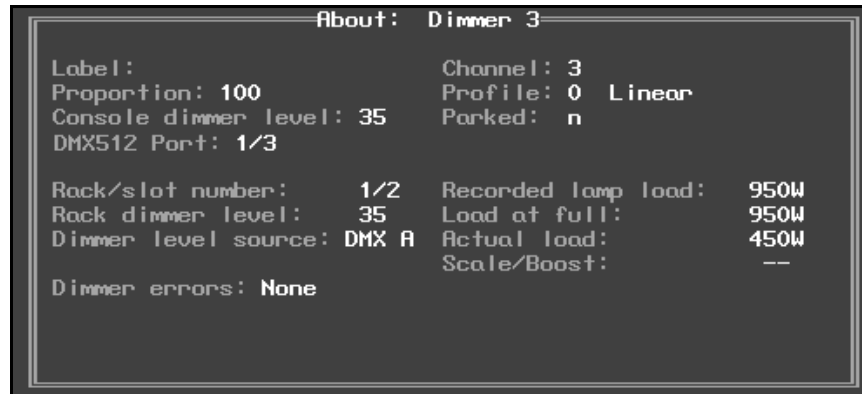

- **Label:** The dimmer's label, if any.<sup>22</sup>
- **Channel:** The channel to which the dimmer is assigned.
- **Proportion:** The dimmer's assigned proportional level.
- **Profile:** The dimmer profile's number and name, if assigned.<sup>22</sup>
- **Console dimmer level:** The dimmer output level the console is sending to the dimmer.
- **Parked** Whether or not the dimmer is parked.
- **DMX512 Port** Port number / address on the port.
- **Rack/Slot number:** The rack and slot in which this dimmer is located.
- **Rack dimmer level:** The actual output level at which the dimmer is set.
- **Dimmer level source:** The source of the control signal which set the dimmer's level. Possible sources include:
  - DMX A**
  - DMX B**
  - Rack #**

The following information is available on Sensor Advanced Features dimming systems.

- **Recorded lamp load:** The load at which the selected dimmer was recorded.
- **Load at full:** The estimated load on the dimmer when the level is at Full.
- **Actual load:** The actual load currently on the dimmer.
- **Scale/Boost:** The dimmer's scale or boost level. Scale is reported in volts (V) and Boost is reported in percentage (%).
- **Dimmer errors:** Describes errors, if any.

## Setting dimmers to Dimmer Doubling

ETC's Dimmer Doubling technology can increase the controllable circuits of a 115 volt, 60 Hz dimming system.<sup>23</sup> Dimmer Doubling converts the output of a single ETC Sensor or L86 dimmer into two separate signals. Both signals then provide discrete levels for two ETC Source Four lights.<sup>24</sup>

You must configure the console by setting the mode of the dimmer and the dimmer's port before the dimmer will function in Dimmer Doubling mode. Each dimmer and port is set individually. Before patching, set the port mode with the procedure given under [Setting the port to Dimmer Doubling, page 313](#).

When a dimmer is doubled, it is functionally split into two dimmers that are distinguished by A and B. For example, dimmer 1 becomes dimmer 1A and dimmer 1B. For each doubled port, the A components of each dimmer are controlled by DMX512 outputs 1-256 and the B components of each dimmer are controlled by DMX512 outputs 257-512. The console represents doubled dimmers in the Patch display as dimmers in the range 1-256, parts A and B.

If a channel was patched to the dimmer before it was doubled, the channel is assigned to both the A and B parts, thus keeping the number of controlled circuits the same rather than doubled. To assign the doubled parts of a dimmer independently, see [Creating a custom patch, page 37](#).

Set dimmers to doubled with the procedure below.

Keystrokes:	Action:
1. Press [Patch].	Selects Patch display
2. Press [Dim] [1][8] [Thru] [3][5]. <sup>a</sup>	Selects dimmers 18 through 35 Prompt reads: <b>Select dimmer numbers, then press ENTER to assign to a channel, or press AT to assign a proportion, or press PROFILE to assign a profile</b>
3. Press [S1], <b>Dimmer Double</b> .	Sets selected dimmers to doubled mode

*a. Often there is no need to press [Dim] in this step because the Patch display defaults on entry to dimmer input.*

---

<sup>23.</sup> *Dimmer Doubling is available only for ETC dimming systems operating nominally at 115 volts, 60 Hz. It is not available for systems operating at other voltages or frequencies.*

<sup>24.</sup> *The Source Four lights should be running 77V HPL lamps when operated by a doubled dimmer.*

## Patching to a Strand CD80 dimmer rack

Strand CD80 dimmer racks have 48 dimmer slots. Each dimmer slot holds either two 2.4kW dimmers or one 6kW or 12kW dimmer. The console requires that you include all 96 possible dimmer numbers per rack in the patch.

Refer to the charts below to determine dimmer numbers for each slot on each rack. When patching 6kW or 12kW dimmers, enter the slot's odd dimmer number under the desired channel number. Enter the slot's even dimmer number under channel zero.

For example, to patch a 6kW dimmer into the last dimmer slot on the first rack, enter dimmer 95 in the desired channel number and dimmer 96 in channel zero.

1	3	5	7	9	11
2	4	6	8	10	12
13	15	17	19	21	23
14	16	18	20	22	24
25	27	29	31	33	35
26	28	30	32	34	36
37	39	41	43	45	47
38	40	42	44	46	48
49	51	53	55	57	59
50	52	54	56	58	60
61	63	65	67	69	71
62	64	66	68	70	72
73	75	77	79	81	83
74	76	78	80	82	84
85	87	89	91	93	95
86	88	90	92	94	96

97	99	101	103	105	107
98	100	102	104	106	108
109	111	113	115	117	119
110	112	114	116	118	120
121	123	125	127	129	131
122	124	126	128	130	132
133	135	137	139	141	143
134	136	138	140	142	144
145	147	149	151	153	155
146	148	150	152	154	156
157	159	161	163	165	167
158	160	162	164	166	168
169	171	173	175	177	179
170	172	174	176	178	180
181	183	185	187	189	191
182	184	186	188	190	192



# ***Chapter 5***

## ***Setting channel levels***

Setting channel levels is the first step in recording cues, submasters and groups. Setting channel levels in Stage mode brings light levels up on stage. Setting channel levels in Blind mode does not affect stage lights.

This chapter includes the following sections:

- Channel modes
- Channel attributes
- Selecting channels
- Setting channel levels
- Channel check
- About Channel

## **Channel modes**

The color and behavior of channels depends upon their modes.

### **Selected channels**

Selected channels are channels over which you have immediate control with the keypad or level wheel. Their channel numbers are displayed in yellow and their levels displayed in red. You can select channels in all display modes. Press [Rel] once to release selected channels.

### **Captured channels**

Captured channels have levels set in the Stage or Fader displays by any source except faded cues or submasters and take precedence over levels set by faded cues or submasters. For example, if you capture a channel at 50 that was faded to 100 percent, you set it to 50 percent. When one or more channels are captured, the message "Captured Channels" appears in red near the top right corner of the display.

Captured channels may be released in a particular order. If no channels are selected and you press [Rel], all dependent channels are released. If you press [Rel] a second time, all independent channels are released. If you had selected one or more channels before pressing [Rel], the first time, only those selected channels would have been released, and further presses of [Rel] would be in the same order as explained above.<sup>25</sup>

Captured channels in fixtures are released essentially the same way. If no fixtures are selected and you press [Rel], all dependent channels are released, including the dependent channels in all fixtures. If you press [Rel] again, all independent channels are released, including the independent channels in all fixtures. If you select a fixture first before you press [Rel], only the dependent channels of that selected fixture are released. Pressing [Rel] a second time releases all independent channels of that selected fixture. Pressing [Rel] on or two times again releases remaining dependent and independent channels as explained above.

### **Recorded channels**

Recorded channels have been recorded in a cue, group, focus point or submaster. Recorded channels may be either moving or tracked in Blind mode (see below). Channel levels controlled by effects are in white in Stage or Fader displays. Channel levels controlled by submasters other than effect submasters are in yellow in Stage displays.

### **Moving channels**

Moving channels are channel levels that change from one cue to the next. In Stage mode, all moving channels are displayed in green. In Blind, moving channels are displayed in green if they are moving down or blue if they are moving up.

### **Tracked channels**

A tracked channel is a channel whose level is unchanged from the preceding cue. Tracked channels are displayed in purple.

---

<sup>25</sup>. See [Channel Attributes display, page 53](#), for a discussion of independent and dependent channels.



# Channel Attributes display

The Channel Attribute display shows the following settings for every console channel.

- Independent**  
 Designates whether a channel is dependent upon or independent of Grandmaster, Flash, Release, Solo, and Blackout control. Independent channels have a “y” in the **Ind** field, while all others have no entry in the **Ind** field. You must press [Rel] twice, or in some cases, three times to release independent channels.
- Flip**  
 Means that the channel’s output is reversed. A flipped channel’s DMX output is at full when the channel is set to zero and at zero when the channel is set to full. In this display, a flipped channel is identified with a “y” in the **Flip** field, while unflipped channels have no entry in the **Flip** field.
- 16-bit**  
 Designates whether a channel is used for 8-bit or 16-bit data. For 8-bit data, there is no entry in the **16b** field. For 16-bit data, the **16b** field can have a “Hi” or a “Lo” label signifying whether the channel sends the higher or lower bits of a 16-bit control signal.
- LTP**  
 Designates whether a channel obeys the Highest Takes Precedence (HTP) or the Latest Takes Precedence (LTP) convention. HTP channels have no entry in the **LTP** field of the display, while LTP channels are identified by a “y” in the **LTP** field.
- Label**  
 You cannot assign labels to channels with an Express console. However, you may make labeling assignments for Express in Expression Off-Line and those assignments will remain when the show is read into an Express console. See [Expression Off-Line, page 306](#).

The screenshot shows the 'Channel Attributes' display with a title bar 'Channel Attributes' and 'Chan' on the right. The time '10:43 AM' is displayed. Below the title is a table with columns: Chan, Ind, Flip, 16b, LTP, Label. The table lists channels 1 through 36. At the bottom, there is a red prompt: 'Select channel number(s) (Channels in ML fixture patch cannot be edited except label)'. Below the prompt is a control panel with buttons labeled S1 through S8.

Chan	Ind	Flip	16b	LTP	Label	Chan	Ind	Flip	16b	LTP	Label
1	y		Hi	y		19	y	y		y	
2	y		Lo	y		20					
3	y		Hi	y		21			Hi	y	
4	y		Lo	y		22			Lo	y	
5	y			y		23			Hi	y	
6	y			y		24			Lo	y	
7	y			y		25				y	
8	y			y		26				y	
9	y	y		y		27				y	
10	y			y		28				y	
11	y		Hi	y		29		y		y	
12	y		Lo	y		30				y	
13	y		Hi	y		31			Hi	y	
14	y		Lo	y		32			Lo	y	
15	y			y		33			Hi	y	
16	y			y		34			Lo	y	
17	y			y		35				y	
18						36				y	

Select channel number(s)  
(Channels in ML fixture patch cannot be edited except label)

S1 S2 S3 S4 S5 S6 S7 S8  
 Independent Flip 16 Bit Previous Page Next Page LTP Link List Return

## ***Editing in the Channel Attributes display***

Channels not patched to fixtures may be fully edited in the Channel Attributes display.<sup>26</sup> Use [Thru], [And] and [Except] if you wish to select multiple channels.

## ***Independent channels***

A channel is normally controlled by the Grandmaster, Flash, Release, Solo, and Blackout functions but can be made independent of them.<sup>27</sup> Use the procedure below to make one channel or a range of channels independent.

<b>Keystrokes:</b>	<b>Action:</b>
1. Press [Setup].	Selects Setup menu
2. Press [1][1] [Enter].	Selects Channel Attributes display
3. Enter channel number(s).	Selects channel(s)
4. Press [S1], <b>Independent</b> .	Prompt reads: <b>Enable/disable independent channel(s) (1 = Enable, 0 = Disable) (Channels in ML fixture patch cannot be edited except label)</b>
5. Press [1] [Enter].	Each selected channel is set as independent

## ***Flipped channels***

Two lights can be made to work in opposite directions if the output of one of them is flipped. For example, if a flipped conventional light and a normal conventional light both are recorded to a submaster, one will brighten and the other darken as the submaster slider is moved. Use the procedure below to flip one channel or a range of channels.

<b>Keystrokes:</b>	<b>Action:</b>
1. Press [Setup]	Selects Setup menu.
2. Press [1][1] [Enter]	Selects Channel Attributes display.
3. Enter channel number(s).	Selects channel(s)
4. Press [S2], <b>Flip</b> .	Prompt reads: <b>Enable/disable flipped channel(s) (1 = Enable, 0 = Disable) (Channels in ML fixture patch cannot be edited except label)</b>
5. Press [1] [Enter]	Each selected channel is set as flipped.

---

<sup>26.</sup> Use the Expression Personality Editor to edit fixture attributes.

<sup>27.</sup> See [Captured channels, page 52](#), for information about releasing channels on stage when they're independent.

## Channel data type

Channels normally contain 8-bit data but may be enabled to contain 16-bit data. Enabling for 16-bit data always involves the next channel in order as well. The enabled channel is called the "HI" channel because it holds the high-order bits of the 16-bit data. The subsequent channel is called the "LO" channel because it holds the low-order bits. Either may be reassigned to 8-bit data, but when you do that, both channels of a 16-bit pair are reassigned at once. Use the procedure below to enable one channel or a range of channels for 16-bit data.

Keystrokes:	Action:
1. Press [Setup].	Selects Setup menu.
2. Press [1][1] [Enter].	Selects Channel Attributes display.
3. Enter channel number(s).	Selects channel(s)
4. Press [S3], <b>16b</b> .	Prompt reads: <b>Enable/Disable 16 bit channel(s)</b> <b>(1=Enable, 0=Disable)</b> <b>(Channels in ML fixture patch cannot be edited except label)</b>
5. Press [1] [Enter].	Each selected channel is set for 16-bit use

## Channel convention

Channels normally operated in HTP mode but may be enabled to operate in LTP mode.<sup>28</sup> Use the procedure below to enable one channel or a range of channels for LTP mode.

Keystrokes:	Action:
1. Press [Setup].	Selects Setup menu.
2. Press [1][1] [Enter].	Selects Channel Attributes display.
3. Enter channel number(s).	Selects channel(s)
4. Press [S6], <b>LTP</b> .	Prompt reads: <b>Enable/Disable "last takes precedence" channel(s)</b> <b>(1=LTP, 0= Normal)</b> <b>(Channels in ML fixture patch cannot be edited except label)</b>
5. Press [1] [Enter].	Each selected channel is set as LTP

---

<sup>28</sup>. See [Output level conventions, page 4](#), for a comparative discussion of HTP and LTP channels.

## Selecting channels

Using the keypad to set channel levels involves two steps: selecting the channels whose levels you want to modify, then entering output levels.

- To select a single channel, enter the channel number preceded by [Channel] if the [Channel] LED is not lit. For example, [Channel] [1] selects channel 1 or just entering 1 will do it if the [Channel] LED is lit.
- To select two channels that are not consecutively numbered, enter the number of the first channel, then press [And] and enter the number of the second channel. For example, [Channel] [1] [And] [7] selects channels 1 and 7.
- To select a group of consecutively numbered channels, enter the number of the first channel, then press [Thru] and enter the last number. For example, [Channel] [1] [Thru] [9] selects channels 1, 2, 3, 4, 5, 6, 7, 8, and 9.
- To exclude consecutive channels from a selected group of channels, press [Except] before entering the channels to exclude. For example, [Channel] [1] [Thru] [1][5] [Except] [5] [Thru] [1][3] selects channels 1, 2, 3, 4, 14, and 15.
- Use [And] to select each non-consecutive channel to include in a selection. For example, [Channel] [1] [Thru] [5] [And] [8] [And] [1][1] selects channels 1, 2, 3, 4, 5, 8 and 11.
- Use [Except] to exclude each non-consecutive channel from a selection. For example, [Channel] [1] [Thru] [5] [Except] [1] [Except] [5] selects channels 2, 3 and 4.
- If no channels are selected, press [Enter] to select all channels currently at a level above zero.

Once you have entered your channel selections, you are ready to set channel levels.

## Selecting channels in Flexichannel mode

In Flexichannel mode, only channels that are used in the show appear on the Stage, Blind and Fader displays. See [Flexichannel, page 18](#), for information on enabling and updating Flexichannel.

When Flexichannel mode is enabled, the [Thru] key functions slightly differently. For example, in normal mode, pressing [1] [Thru] [5] selects all channels from 1 to 5. In Flexichannel mode, pressing [1] [Thru] [5] selects all **visible** channels from 1 to 5.

To select all channels from 1 to 5, including channels that haven't been used in the show so far, press [1] [Thru] [Thru] [5]. Pressing [Thru] a second time alerts the system to ignore Flexichannel for that channel selection.

## Setting channel levels

You assign output levels to channels using the basic format [Channel] [#] [At] [#] where the first number is the channel and the second is the level. For example, [Channel] [4] [At] [7][5] sets channel 4 at 75 percent. If you enter a single digit for the level, the console multiplies it by ten and you must follow it with [Enter]. In other words, [Channel] [4] [At] [1] [Enter] sets channel 4 to 10 percent. To set channel 4 to 1 percent, enter [Channel] [4] [At] [0][1].<sup>29</sup>

### Trackpad

To set channel levels with the trackpad, select the channels whose levels you want to modify, then move your finger up or down on the trackpad to set the desired output level.

There are two ways to select channels for trackpad adjustment. You can specify them on the keyboard or you can select all those channels at once whose levels are above zero. As an example of the first of these, press [Channel] [1] [Thru] [5]. To select all non-zero channels, press [Enter].

### Full

Press [Full] to set selected channel levels to 100 percent. For example, press [Channel] [1] [Thru] [3] [Full] to set channels 1, 2 and 3 to 100 percent.

### Level key

[Level] sets selected channel levels to the output level assigned to the [Level] key. The default value for [Level] is 100 percent. (See [Setting default Level key, page 25](#), for instructions on changing the Level key's setting.) For example, if Level is set at 75 percent, press [1] [Thru] [5] [Level] to set channels 1, 2, 3, 4, and 5 to 75 percent.

### Flash

Flash sets the selected channel's level to 100 percent if the channel is currently at a level at or below 50 percent. If the channel's level is above 50 percent, **Flash** sets it to zero. Levels set by Flash are only maintained while the key is pressed. For example, press [Channel] [5], then press and hold [S8], **Flash**, to set channel 5 to either 100 or zero.

---

<sup>29</sup> To clear channels, press [At] [Clear].

# Sneak

Sneak is a softkey that you can use to fade channels on stage to a level you choose in a specific time or to restore channels to the last level at which they were set with a fader or submaster. For example, if you bring up a cue, then change the look, you can use sneak to go back to the look created by the original cue. You can use Sneak with groups, submasters and focus points as well as with cues.

If you do not indicate a time, the sneak occurs in the default sneak time, set in System Settings.

Follow these steps to use Sneak to set a channel level.

Keystrokes:	Action:
1. Press [Stage].	Selects Stage display mode
2. Press [S1], <b>Sneak</b> .	Selects Sneak mode Prompt reads: <b>Sneak mode - Select channels, then press ENTER to sneak, or AT to select sneak level, or TIME to select sneak time</b>
3. Select the channel(s) you want to sneak and the level to which you want it to fade. For example, press [5] [At] [5].	Selects channel 5. Sets level at 50 percent Prompt reads: <b>Sneak mode - Select level</b>
4. Press [Time] and enter the time for the sneak. For example, press [Time] [1][0].	Selects Sneak time of ten seconds Prompt reads: <b>Sneak mode - Select time</b>
5. Press [Enter].	Fades channel 5 to 50 percent over ten seconds

Follow these steps to restore a channel to its last fader or submaster level.<sup>30</sup>

Keystrokes:	Action:
1. Press [Sneak] and select the channel(s) you want to restore. For example, press [5].	Selects channel 5 to sneak Prompt reads: <b>Sneak mode - Select channels, then press ENTER to sneak, or AT to select sneak level, or TIME to select sneak time</b>
2. Press [Enter].	Fades channel 5 back to its most recent cue or sub level

---

<sup>30</sup>. Press [Sneak] [Enter] to restore all channels to their current fader or submaster levels.

## Channel check

Use a Channel Check to check which channel controls which light. The console allows you to check channels by selecting a single channel and flashing it to a level.<sup>31</sup> Once you have selected a channel you can then advance sequentially through the channels, checking one at a time. You may start a channel check with any channel.

Follow these steps to run a channel check:

<b>Keystrokes:</b>	<b>Actions:</b>
1. Press [Stage].	Selects Stage display Prompt reads: <b>Select channel numbers</b>
2. Press [Channel] [1].	Corner reads: <b>Chan 1</b>
3. Press [S7], <b>More Softkeys.</b>	
4. Press and hold [S8], <b>Flash.</b>	Sets channel 1's level to 100 percent if its current level is at or below 50 percent or... Sets channel 1's level to zero if its current level is above 50 percent
5. While holding [S8], press [+] or [-] to select the next or previous channel.	Flashes each channel in turn
6. Once you have checked all the channels, release [S8], <b>Flash.</b>	

---

<sup>31.</sup> *If a channel is independent, it will not flash in response to a channel check.*

## About Channel

The About Channel display gives you information about the characteristics, patch and use of individual channels. It can be displayed while in any other display. For similar information about dimmers, see [About Dimmer, page 46](#).

Go to the About Channel display as follows.

Keystrokes:	Action:
1. Press [About] [Channel].	Prompt reads: <b>About: Select channel number, then press ENTER</b>
2. Press [6].	Keypad corner reads: <b>Chan 6</b>
3. Press [Enter].	About Channel window is displayed. <sup>a</sup>

a. Press [Clear] to remove the window.

### Features of the display

Following is an About Channel display for a channel patched to a fixture attribute. When a channel is either unpatched or patched to a conventional light, the Fixture and Type fields shown below are replaced by a Link field. When a name or label is indicated below, see [Expression Off-Line, page 306](#), for information about assigning labels,



- **Label** Name, if any, assigned to the channel.
- **Fixture** (Only for channels patched to a fixture)  
Number and name, if any, assigned to the channel in Fixture Patch.
- **Type** (Only for channels patched to a fixture)  
Name of the personality used for this fixture.
- **Link** Link number, if any.
- **Device** If channel is patched to a fixture, Device shows the assigned fixture attribute. If channel is on a Link List, Device shows which trackpad axis is assigned.



- **Attributes** Channel characteristics, such as:
  - ▼ **Ind** The channel is independent.<sup>32</sup>
  - ▼ **16b Hi** The channel controls the high bits portion of 16-bit data.<sup>32</sup>
  - ▼ **16b Lo** The channel controls the low bits portion of 16-bit data.<sup>32</sup>
  - ▼ **Flip** The channel's output has been reversed.<sup>33</sup>
  - ▼ **LTP** The channel's convention is LTP.<sup>32</sup>
- **Source** Identifies how the channel is being controlled, e.g. cue number, background cue number, captured, fader pair, submaster number.
- **First used** The first cue in which this channel appears.
- **Last used** The highest numbered cue in which this channel appears.
- **Number of cues** The total number of cues in which this channel appears.
- **Number of moves** The total number of cues in which this channel moves.
- **Level** The channel's current level and focus point reference, if any.
- **Inhibited** The inhibitive submaster, if any, which is controlling the level of the channel.
- **Dimmers** The dimmers assigned to the channel, as space permits.

---

<sup>32.</sup> Editable in the Channel Attributes display except for channels patched to ML fixtures. This feature is editable for ML fixtures in the Expression Personality Editor.

<sup>33.</sup> Editable in the Channel Attributes display except for channels patched to ML fixtures. Editable in Fixture Patch for channels patched to ML fixtures.



# *Chapter 6*

## *Adding moving lights to the show*

The first step in working with moving lights is to add them to your show. Then, when your console has information about what types of fixtures, personalities and fixture attributes you are using, you are ready to customize your console to work most efficiently with them. Both steps are initiated from the Moving Light Functions menu.

This chapter contains the following sections:

- The Moving Lights Function menu
- Personality setup and editing
- Patching moving light fixtures and fixture editing
- Attribute setup and category editing
- Encoder setup
- Using the moving lights Fixture Box
- Fixture focus with Solo

## Moving Light Functions menu

Go to the Moving Lights Functions menu by pressing [Setup] [1][5] [Enter].



1. **Personality Setup** - The console comes with default personalities already included in its system software code. These may not be sufficient for your purposes, however, and you may need to add additional ones. Work directly with personalities here.
2. **Fixture Patch** - Once you have the personalities in the console that you need, begin the task of patching fixtures with those personalities. In addition to patching, you can customize here by labeling and modifying the standard patching.<sup>1</sup>
3. **Attribute Setup** - Go to this display to customize the assignment of fixture attributes to categories. Later during the creation of your show, this categorization will help you grab the moving light attributes you want by color, position or other traits to set levels, create cues, etc. The attributes used in your show are highlighted in the Attribute Setup display.
4. **Encoder Setup** - This display allows you to customize the assignment of the trackpad to fixture attributes for greater level-setting convenience. The console helps you here too by highlighting those fixture attributes you are using so you can easily put them where you want them.

---

<sup>1</sup> You can assign labels to dimmers in *Expression Off-Line*. See [Expression Off-Line, page 306](#).

# Personality Setup

You may find that the default personalities embedded in console software are sufficient for your needs. If not, you may be able to get the personality you need from ETC or create it yourself. See [Personalities, page 7](#), to learn about these options.

All personalities can be included in your show or deleted from it to save console memory. You may also inspect a personality in your show.

## Go to the Personality Setup display

1. Press [Setup] [1][5] [Enter] to display the Moving Lights Functions menu.
2. Press [1] [Enter] to go to the Personality Setup display

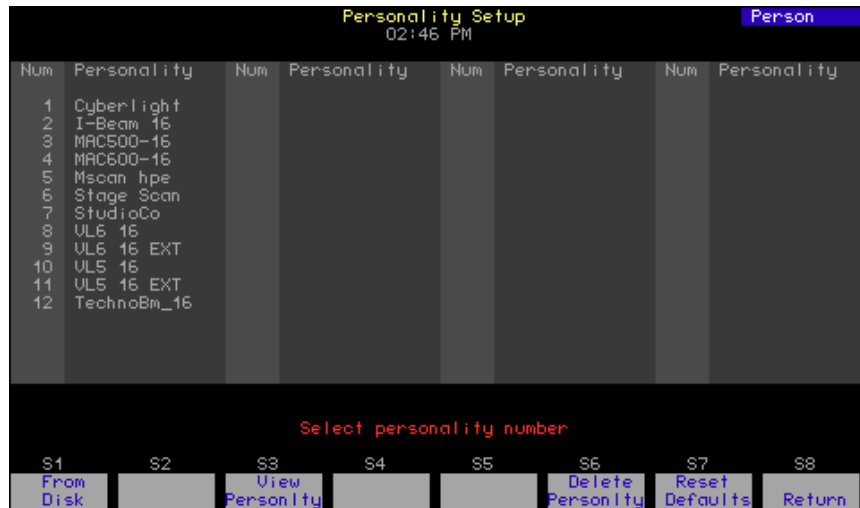

Navigation and Feedback - Personality Setup display					
		[S]			
Select a personality	X		X		X
Yellow highlighting	Personality selected in the display				
Purple highlighting	Personalities in use in the show				

## Loading personalities into the console

You may load additional personalities to your show if you find that the default personalities are not sufficient for your needs. Any personalities loaded to your show are saved with your show.

Load personalities to your show from a diskette. If you obtained the extra personalities from ETC's internet website, store them first on your hard drive, preferably in the Shows directory set up by Expression Off-Line. See the Expression Off-Line QuickGuide for information about using Off-Line to create and edit shows for your console.

When you are ready to load personalities to your show, transfer what you need from your computer to a diskette. The console loads all files from the diskette to your show at once. Follow the procedure below to load personality files.

1. Insert the 3.5-inch diskette in the console disk drive.
2. From the Personality Setup display, Press [S1], **From Disk**, [Enter].
3. Remove and store the diskette when the transfer is complete.

**WARNING** - If possible, always load personalities before patching. If you try loading a personality with the same name as one you already have in your show, you will get the warning shown below. If you are replacing a personality with one that assigns more channels, the automatic repatching will cause erroneous overlapping. Such overlapping can cause unexpected or inconsistent behavior from recorded elements such as groups and cues used in the show. You may need to repatch fixtures.

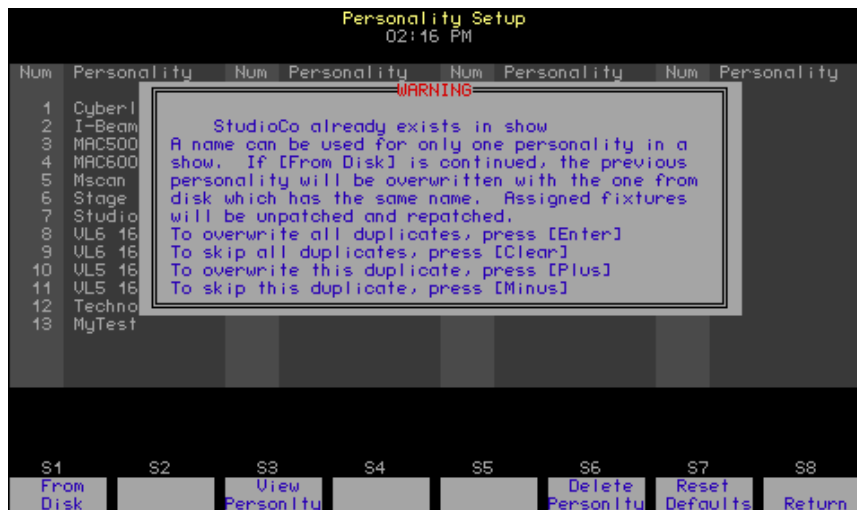

## ***Viewing a personality***

1. From the Personality Setup display, type the number of the personality you want to view.
2. Press [S3], **View Personality** and the view display appears. To view another personality, scroll with the [+ ] or [- ] keys.
3. Press [S8], **Return**, to return to the Personality Setup display.

## ***Deleting personalities***

You may delete personalities from the show either one at a time or in groups using the [+], [-], [And] or [Thru] keys.

1. From the Personality Setup display, press [S6], **Delete Personality**.
2. Type the number of the personality you want to delete, followed by [Enter] to confirm your choice. If you change your mind after selecting a personality, press [Clear] to begin again.

## ***Resetting defaults***

You may restore any of the default personalities that were deleted. When restoring the default personalities, any uploaded personalities are deleted. To reset defaults, go to the Personality Setup display, Press [S7], **Reset Defaults**, and complete the action by pressing [Enter].

**WARNING** - *Resetting restores default personalities. If you loaded a personality with the same name as a default and used it in your show, the fixtures patched with that personality will be repatched using the default.*

## Patching moving lights

Fixtures are installed in the Fixture Patch display in numerical order, either singly or in ranges.

### Go to the Fixture Patch display

There are two ways to get to the Fixture Patch display. Either select option 2 from the Moving Light Functions menu or press [S8], **Fixture Patch**, in the Patch display.<sup>2</sup>

Fixture Number	Label	Personality	Start Chan	DMX512 Start	Remote Dimmer	Swap Focus	Flip	Intens Chan
1		2 I-Beam 16	1	1/1	n			8
2		2 I-Beam 16	11	1/11	n			18
3		2 I-Beam 16	21	1/21	n			28
4		2 I-Beam 16	31	1/31	n			38
5		2 I-Beam 16	41	1/41	n			48
6		1 Cyberlight	51	1/51	n			68
7		1 Cyberlight	71	1/71	n			88
8		1 Cyberlight	91	1/91	n			108
9		1 Cyberlight	111	1/111	n			128
10		1 Cyberlight	131	1/131	n			148

Select fixture number(s)

S1 Select Fixture   S2 Label   S3 Personality   S4 Previous Page   S5 Next Page   S6 Delete Fixture   S7 More Softkeys   S8 Return

Navigation and Feedback - Fixture Patch display					
		[S]			
Select a fixture	X	X	X		X
Select a feature		X		X	
Make a change	X				X
White line	Indicates fixture selected				
Yellow coloration	Indicates feature selected				

<sup>2</sup> Pressing [S8], **Return**, in Fixture Patch returns you either to the Moving Lights Functions menu or to the Patch display, depending upon which of the two you were in just prior.



## Patching one fixture or a fixture range

The following procedure makes use of the automatic cursor movement from field to field for efficient data entry. When patching a range, all range members receive the same assignments except as noted below. Alternatively, you can use softkeys at any time to make entries in specific fields, such as to individualize labels when fixtures are patched as a range.

1. **Fixture Number:** Enter the fixture number or range. Fixtures are entered in order, starting with “1”. Press [Enter].
2. **Label:** Can be assigned with Expression Off-Line. See [Expression Off-Line, page 306](#).
3. **Personality:** Enter the number of the personality from the list of personalities you have available. Alternatively, scroll through the personality choices with the [+] or [-] keys. Press [Enter] to select.
4. **Start Channel**<sup>3, 4</sup>: Enter a number for the first channel to be assigned to the fixture(s). If entering a range, picking the Start Channel assigns a sequential start channel to every fixture in the range. Press [Enter].
5. **DMX512 Start**<sup>3, 5</sup>: Enter the number of the desired DMX port. Press [Enter]. The cursor remains in the DMX512 start field but moves to the right of a slash inserted in the field. Enter an address for the fixture within the DMX port (1-512). If entering a range, picking the DMX address assigns a sequential address at that port to every fixture in the range. Press [Enter].
6. **Remote Dimmer:** If the personality signals that the fixture has its own dimmer, an “n” automatically appears in this field. If the fixture needs a remote dimmer, enter the dimmer’s number. If entering a range, picking the dimmer number automatically assigns a unique dimmer to every fixture in the range. Press [Enter].
7. **Swap Focus:** If you use a pointing device, pan level adjustment is normally on the X-axis and tilt level adjustment is normally on the Y-axis. Regardless of where pan and tilt level adjustments are assigned, you may reverse these assignments with Swap Focus. Follow the onscreen prompt or toggle with the [+] or [-] keys to switch between swap and normal. Press [Enter].
8. **Flip:** Normally, when the control to which pan or tilt is assigned is increased, the level increases too. You may invert this relationship for pan or tilt with Flip, which can be used to “mirror” two moving lights. In Fixture Patch, Pan is prompted first, tilt second. For each, follow the onscreen prompt or toggle with the [+] or [-] keys to switch between flip and normal. Press [Enter] to complete each assignment.
9. **Intensity Channel:** Identifies the channel number of the fixture’s intensity channel.

---

3. An **Advisory** appears if you choose a Start Channel or DMX512 Start address that overlaps patchings for other fixtures. A **Warning** appears if the start address is too high. Press [Clear] to remove the **Advisory** or the **Warning** and make other selections.

4. After a fixture’s start channel is selected, levels can be set for the fixture’s attributes and recorded into cues. The console will not control the moving light, however, until DMX512 addresses have been set.

5. The port and starting address must be set so that there are enough DMX512 outputs for all the attributes of all the fixtures.

## ***Editing the fixture list***

You may edit or delete fixtures individually or in groups in the Fixture Patch display.<sup>6</sup>

### ***Editing a fixture***

1. From the Fixture Patch display, enter the fixture number(s).
2. Use the left/right arrow keys to move to the field where you want to make a change. Enter a numeric value or scroll with the [+] or [-] keys to make the change. Press [Enter].

### ***Deleting a fixture or a range of fixtures:***

1. From the Fixture Patch display, press [S6], **Delete Fixture**. If **Delete Fixture** is not displayed as a softkey, press [S7], **More Softkeys**, first, then press [S6], **Delete Fixture**.
2. Enter the fixture number(s).
3. Press [Enter] to delete, or press [Clear] to re-select.

---

<sup>6</sup> *When an edit field and fixture are selected, you can move quickly to other edit fields or fixtures with the arrow keys. Use the left/right arrows to move to other edit fields and the up/down arrows to move to other fixtures.*

## Attribute Setup

Personalities may have as many as 64 attributes. Most of the 64 attributes have names that describe the function to which they are assigned, such as pan, tilt, gobo or strobe. The rest have either User or Reserved designations and are unassigned.

The system software assigns each attribute to one of five categories by default, but you can change these assignments. The category assignments affect all fixtures in the show alike. See the list of categories and examples of attributes assigned to them in the table below.

Categorization provides a way for you to refer to attributes during programming in relation to their function (such as position or color) rather than to attributes by their individual names. Use the Only command when referencing attribute categories.

Default attribute category assignments	
<b>Position</b>	Position attributes, such as pan and tilt, control the direction of the fixture.
<b>Beam</b>	Beam attributes, such as intensity and zoom, control the quality of the fixture's field.
<b>Image</b>	Image attributes, such as gobo and F/X, control the shape of the fixture's field.
<b>Color</b>	Color attributes, such as cyan and magenta, control the color of the fixture's beam.
<b>None</b>	None are those attributes, such as speed and control, not included in the other four categories.

## Go to the Attribute Setup display



The Attribute Setup display lists all attributes and identifies their category assignments. You can change the categories to which an attribute is assigned by adding or removing them in this display. Every attribute must be assigned to at least one category. Multiple category assignments are allowed except when an attribute is assigned to the None category.

1. Press [Setup] [1][5] [Enter] to display the Moving Light Functions menu.
2. Press [3] [Enter] to go to the Attribute Setup display.

Attribute		Category	Attribute		Category
1	Intens	Beam	17	Zoom	Beam
2	Pan	Posit	18	Focus	Beam
3	Tilt	Posit	19	Iris	Beam
4	Color	Color	20	Frost	Beam
5	Color2	Color	21	Pan Ro	Posit
6	Cyan	Color	22	TiltRo	Posit
7	Magent	Color	23	Beam1a	Beam
8	Yellow	Color	24	Beam1b	Beam
9	Gobo	Image	25	Beam2a	Beam
10	GoboRo	Image	26	Beam2b	Beam
11	Gobo2	Image	27	Beam3a	Beam
12	Gobo2R	Image	28	Beam3b	Beam
13	F/X	Image	29	Beam4a	Beam
14	F/X Ro	Image	30	Beam4b	Beam
15	Prism	Beam	31	BeamRo	Beam
16	Strobe	Beam	32	Speed	None

Select attribute number

S1	S2	S3	S4	S5	S6	S7	S8
Select Attribute	Category		Previous Page	Next Page		Reset Defaults	Return

Navigation and Feedback - Attribute Setup display					
		[S]			±
Select an attribute	X	X	X		X
Select a category		X		X	
Make a change	X				
Purple coloration	Attributes used in the show				
Gray coloration	Attributes not used in the show				
Yellow coloration	Item selected				

### Changing an attribute's category assignment:

1. Enter the number of the attribute. Press [Enter].
2. For each category to be added or removed, enter its assignment number (0=**None**; 1=**Position**; 2=**Image**; 3=**Color**; 4=**Beam**). Entering the number either adds or removes the category depending upon whether the attribute is already assigned to it or not.
3. Press [Enter] after you have made all changes. You may start over at any time by pressing [Clear] or typing 0 to choose None.

### Resetting defaults:

Each of the 64 attributes has a unique default category assignment. To reset all attributes to their category defaults, go to the Attribute Setup Display. Then, Press [S7], **Reset Defaults**, followed by [Enter].

# Encoder Setup

Encoders are rotating level setting devices that are either installed in some consoles or available as an attachment. Express consoles do not use encoders but can make use of encoder pages to provide easier access to a number of fixture attributes.

The encoder Setup display allows you to change the assignment of fixture attributes among your level-setting devices and pages. For Express, that means you can choose which attributes are assigned to the two axes of the trackpad, TX and TY, for the six pages available.

The default assignment is to have the pan and tilt attributes on the trackpad for every page. That means you can retain the convenience of having the position attributes on the trackpad for one of those pages and make alternate attribute assignments on the remaining 5 pages.

## Go to the Encoder Setup display

1. Press [Setup] [1][5] [Enter] to display the Moving Light Functions menu.
2. Press [4] [Enter] to go to the Encoder Setup display.



Navigation and Feedback - Encoder Setup					
		[S]			$\pm$
Select an encoder	X	X	X		X
Select a page	X	X		X	X
Assign attribute	X				X
Purple coloration	Attributes used in the show				
Gray coloration	Attributes not used in the show				
Yellow coloration	Encoder/page selections				
White coloration	Attribute field selected				

## Changing assignments

Encoders and other level setting devices are assigned to 44 of the 64 available attributes by default. You may change the default settings to suit your individual needs, such as to reassign attributes that you most commonly select to suit your individual setup or preferences. You may not, however, assign an attribute to more than one location on a page.

There are three ways to change assignments in the Encoder Setup display: individually, automatically and back to defaults.

### Change individually

1. Select a trackpad axis with the up/down arrows.
2. Select Page 1 with the left/right arrows. Press [Enter].
3. Select an attribute with the [+ ] or [- ] keys.
4. Continue making changes until done.

### Change automatically

The console can make automatic level setting assignments for all fixture attributes you are using in your show. One reason you may want to use this automatic assignment feature is to ensure that all your attributes are included in the encoder setup (20 do not appear in a default setup). Another reason is to quickly concentrate your attributes on the lower-numbered pages, thus reducing the need to change pages when setting levels. Only attributes in the current show are assigned. pan and tilt are assigned to the trackpad on every page.

This feature is available as a softkey called Autoload Encoders in Fixture Patch or in the Encoder Setup display (in Fixture Patch, you may need to press [S7], **More Softkeys**, first). In the Encoder Setup display, press [S6], **Autoload Encoders** (you must press [Enter] twice to confirm). After executing an Autoload assignment, the Encoder Setup display resembles the one shown in the illustration below.

Encoder	Page 1	Page 2	Page 3	Page 4	Page 5	Page 6
1	Intens	GoboRo	Focus			
2	Color	Gobo2	Iris			
3	Color2	Gobo2R	Frost			
4	Cyan	F/X	Speed			
5	Magenta	Prism	Contrl			
6 X	Yellow	Strobe				
7 Y	Gobo	Zoom				
8 TX	Pan	Pan	Pan			
9 TY	Tilt	Tilt	Tilt			

Select encoder number

S1 Select Encoder	S2 Page	S3 Attribute	S4	S5	S6 Autoload Encoders	S7 Reset Defaults	S8 Return
----------------------	------------	-----------------	----	----	-------------------------	----------------------	--------------

### Resetting defaults

You may return to the default level setting assignments anytime you wish. In the Encoder Setup display, press [S7], **Reset Defaults**, and press [Enter] twice to confirm.

# Working with moving lights

## Moving lights displays

Moving lights and conventional lights use the same Blind and Stage displays. Each moving light, however, is distinguished in these displays by a gray bar surrounding the numbers of all channels in the fixture. Also, channels that carry the low order bits of 16-bit attributes have dimmed channel numbers.

Levels are set for the channels of moving light fixtures in a Fixture Box window that pops up in Blind and Stage displays when a fixture is selected.<sup>7</sup> The list under the screen shot below identifies the contents of the Fixture Box window.

## Go to the Fixture Box window

1. Press the [Stage] or [Blind] key.
2. Press [S8], **Fixture**.
3. Enter a fixture number(s). The fixture box appears.



Following are features of the Fixture Box.

- The fixture is identified by number, label (if assigned) and personality.
- Page numbers are shown in white if any of the fixture's attributes are on that page. The current encoder page is identified in yellow.
- The fixture's attributes on the current page are identified in gold.
- The level assigned to each identified attribute is identified in the "Value" line. For 8-bit data types, the level is given as a percentage. For 16-bit data types, the level is given as a value in the range 0-65535.
- The level setting device assigned to each identified attribute is identified, where TX and TY are the axes of the trackpad.<sup>8</sup>

<sup>7</sup> When a range of fixtures is selected, the Fixture Box contains information pertaining only to the last fixture in the range.

<sup>8</sup> E1-E5 are for encoders; X and Y are for wheels. These settings are inapplicable to Express consoles which have neither encoders nor wheels.

## ***Working with fixtures***





Following are some principles to keep in mind when setting fixture attribute levels.

- If a fixture has a strobe attribute, that attribute must be set above zero so that the light can be seen.
- The intensity attribute is selected by default unless you select an attribute. Use this as a shortcut method to set fixture intensities. For example, set the intensity of three moving lights on stage by pressing [Stage] [S8], **Fixture**, [1] [thru] [3] [Full].
- If you wish, you can assign attribute levels without using the Fixture Box. For instance, if a fixture is patched to channels 1 through 20, you can set the levels of channels 7 and 8 as follows: press [Stage] [Channel] [7] [And] [8] [At] [5] [Enter].
- If you are working with fixtures directly but don't want the Fixture Box on the screen, press [Clear] to remove it. The encoders remain active when the Fixture Box is cleared. You can clear away the Fixture Box even in the midst of a lengthy command sequence without altering the results. For instance, set the intensity of fixtures 1 through 3 to full and clear away the Fixture Box in one command sequence as follows: press [Blind] [S8], **Fixture**, [1] [thru] [3] [Clear] [Full].



## Setting levels in the Fixture Box

Use the procedure below this Navigation and Feedback table to set attribute levels in the fixture box.

Navigation and Feedback - Fixture Box display				
				
Select fixture	X			X
Select page		X		
Select attribute			X	
Page highlighted white	Fixture attributes exist on page			
Page highlighted yellow	Selected page			
Attribute gold	Attribute of selected fixture			
Attribute highlighted yellow	Selected attribute			

1. With a fixture in the Fixture Box, press the up/down arrows to select a page.
2. Select an attribute with the left/right arrows.
3. Adjust the level of the selected attribute with the trackpad.<sup>9</sup>
4. If there are other fixture attributes on the same page that you wish to set, repeat steps 2 and 3 above. Continue until finished with all attributes on that page.
5. If attributes of this fixture are on a different page, repeat steps 1 through 4 above. Continue for all pages on which the fixture's attributes are located.
6. To set the channel levels of another fixture, select the fixture with the [+] or [-] keys.
7. Repeat steps 1 through 6 until finished with all fixtures.

<sup>9.</sup> *Pan and tilt are always selected together when either is selected. Whichever of these two attributes is selected is placed on one axis of the trackpad and the other of the two is placed on the second axis.*

## ***Fixture focus with Solo***

Solo provides a convenient way to point or otherwise adjust a selected moving light without the interference of others. Even better, you can increment through fixtures one at a time, adjusting as you go, with a single execution of the solo function.

There is no reason to use solo in Blind because the Fixture Box has a similar incrementing feature. If you do use it in Blind, however, be aware that solo leaves the levels for the selected fixture set and all the rest at zero.

### **Example:**

1. Patch fixtures 1-10.
2. Press [Stage].
3. Select fixtures 1-10 and set levels.
4. Press [S8], **Fixture**, [1] [S7], **More Softkeys**, [S5], **Solo**.  
Brightens fixture 1 and darkens all other lights.
5. Adjust the fixture.
6. Press the **+** or **-** keys to solo the next fixture.  
Solo the next fixture.
7. Repeat steps 4 and 5 until finished.  
Increment through all fixtures.
8. Press [S5], **Solo**.  
Return to the complete look on stage.

# Chapter 7

## Cues

The console allows you to save up to 600 cues per show.<sup>10</sup> Cues consist of channel levels and cue attributes. Multiple attributes can be applied to one cue.

This chapter shows you how to create and modify cues as well as copy and delete them. Play back a recorded cue using the procedures given in [Chapter 10 Playing back cues, page 119](#).

The examples in this chapter assume there are no cues stored in the console. To clear all cues in memory, press [Setup] [4] [Enter] [2] [Enter] [Enter]. Before you do that, however, consider saving the contents of memory as a show using the procedures given in [Chapter 20 Diskette functions, page 243](#).

Chapter seven contains the following sections:

- Cue types
- Record functions
- Creating cues
- Viewing cues
- Working with cues in Stage mode
- Recording a cue in Stage
- Working with cues in Blind mode
- Recording a cue in Blind
- Recording a cue with a single fade time
- Recording a cue with split fade times
- Recording a cue with a wait time
- Recording cues with Link and Follow
- Recording a cue using Solo
- Labeling cues
- Modifying a recorded cue live
- Modifying cue attributes
- Using Update to modify a cue
- Deleting cues
- Copying cues
- Inserting cues

---

<sup>10.</sup> *If you need more than 600 cues in your show, see [The oversized show, page 82](#).*

## **Cue types**

[Type] displays all but one of the fade type options described below. The subroutine option is discussed under [Chapter 17 Subroutines, page 219](#).

To select a cue fade type in Stage, Blind or Fader modes, press [Type], and enter the type number given in the prompt. If you change a cue's fade type, you must re-record the cue. For example, [Cue] [2] [Type] [2] [Record] [Enter] records cue 2 with an allfade. Cues default to crossfade when you do not enter a fade type.

### **Crossfade**

In a crossfade cue, channel levels that increase fade to their new level in the assigned upfade time. Channel levels that decrease fade to their new level in the assigned downfade time. The cue starts when you press [Go]. You may use a wait time to delay the start of the upfade or downfade.

### **Allfade**

An allfade cue forces all unused channels to zero intensity when you press [Go] and clears the other fader. Allfade is useful for forcing an end cue when tracking channels. For more information on using allfade cues for tracking, see [Chapter 8 Track](#).

### **Effect**

An effect cue contains an effect. Effects allow you to assign channels to a series of steps. When you play back the effect, the steps run in assigned chase patterns, or in random order. For more information on using effects, see [Chapter 16 Effects](#).

### **Blocking**

A blocking cue forces all LTP channels to fade to completion in background cue timing and then runs in a physical fader like any other cue. One use for a blocking cue is to end background effect cues under program control. For more information on blocking cues in relation to LTP channels, see [Working with LTP channels, page 5](#).

### **Subroutine**

A subroutine is a cue that controls the playback of a series of recorded cues. Subroutines are similar to linked cues, except that you have more playback options. For more information on using subroutines, see [Chapter 17 Subroutines](#).

## ***Recording functions***

The console has two record functions: Record and Track. Record saves all channels as they appear on the screen (what you see is what you get) in the cue, group or submaster you specify. When you use Record to record a cue, levels are recorded in only one cue.

Track is a record function that works only with cues. It allows you to build a new cue from the previous cue's channel settings. Tracked channels are channels whose levels do not change from one cue to the next. A *track* often runs through several cues for the length of a scene or an act.

Track also allows you to add tracked channels through existing cues. For example, if you have created all cues for a scene, and then decide to add a few new channels to all cues, or adjust the level of a channel throughout the cues, Track lets you do so with one short record command. To do the same thing with Record would require you to add the new channels to each cue individually.

*Note: When a channel level that tracks through a series of cues reaches an Allfade cue, the track ends.*

We use the standard Record function for all cues in this chapter. Instructions for using the Track function are included in [Chapter 8 Track](#).

## ***Viewing cues***

You can view stored cues in two ways, live in Stage or Fader displays or on the monitor in Blind mode.

To view cues live, you must select the cue and play it back in a fader. See [Chapter 10 Playing back cues, page 119](#), for instructions.

To view a cue only on the screen, select Blind mode and enter the desired cue number. To view a different cue, press [Cue] and the new cue number that you want to see.

In Blind mode you can also use [+] and [-] to move through recorded cues and cue parts, one at a time. Press [Cue], then press [+] to display the next cue or part. Press [-] to display the previous cue or part.

## ***The oversized show***

If your show requires more than 600 cues, you can still run it by creating the show in segments, with each segment having less than 600 cues. Follow the procedures below to create and play back an oversized show as a series of separate show segments.

### ***Creating the oversized show***

Let's assume that you want to create a show containing 800 cues. Create the intended show as two, separate shows using the following procedure:

1. Create a show containing the first 400 cues and store it on a diskette called *Beginning*. You will have the show called *Beginning* stored on diskette as well as in console memory.
2. Next, erase all cues from the show in the console memory (not the one on diskette).
3. Re-program that show in memory for the remaining 400 cues you need.
4. Store that second show on a new diskette called *End*.

### ***Playing back an oversized show***

1. When it's time to play back the show, load and play back the show called *Beginning*.
2. When all cues in *Beginning* have been played, load and play back the show called *End*. Arrange the break between shows *Beginning* and *End* so that it occurs during a natural break in the show or between cues.

**Note:** If you load in show *End* while playing a cue from show *Beginning* in the faders, you will not be able to view that *Beginning* cue in the Blind display. Instead, the Blind display will show the first cue in show *End*.

## Working with cues in Stage

When recording in Stage, such as to record a cue, group or submaster, you will commonly want to start without any live channels. For instance, you may want to create a new cue without using any of the lights placed on stage from a previous fade or channel selection. To clear lighting from the stage, use one or all of the following procedures:

- If the lights are from a cue in a fader, press the fader's [Clear] key one or more times.
- If the lights are captured, press [Rel] two or more times.
- If from a submaster, lower the slider to zero.
- If from channels running in the background, press [S3], **Background Overrides**, [Enter] [Enter].

## Recording a cue in Stage

There are several ways you can create a cue from a look on stage. If you have several cues already stored, you may want to base a new cue on the look already recorded for another cue. You would do that by playing the cue in the faders and then modifying the resulting look on stage.

In other circumstances, you may want to enter all channel levels manually. That is the procedure used below. When creating this cue, you will only set channel levels. Default settings will determine all other attributes of the cue. You can change most default settings from the System Settings menu. See [Chapter 3 System settings](#), for information about setting and changing defaults.

Follow these steps to record cue 1:<sup>11</sup>

<b>Keystrokes:</b>	<b>Action:</b>
1. Press [Stage].	Selects Stage display mode Prompt reads: <b>Select channel numbers</b>
2. Press [1] [Thru] [1][0].	Selects channels 1 through 10
3. Press [At].	Prompt reads: <b>Enter intensity</b>
4. Press [5][0].	Sets a level of 50 percent for channels 1 through 10
5. Press [Record].	Prompt reads: <b>To record cue, select number and press ENTER</b> <b>To cancel, press CLEAR</b>
6. Press [1].	Selects cue 1
7. Press [Enter].	Records cue 1 containing channels 1 through 10 at 50 percent
8. Press [Rel].	Releases captured channels

---

<sup>11</sup>. Note that the keypad defaults to cue mode when you press [Record].

## Working with cues in Blind

Blind mode allows you to create, preview or modify cues without affecting the current look on stage. If you prefer to work with live looks, you should work in Stage mode.

### Recording a cue in Blind

#### Keystrokes:

1. Press [Blind].
2. Press [2].
3. Press [Channel] [1][3] [And] [1][5].
4. Press [Full].<sup>a</sup>
5. Press [Record].
6. Press [Enter].

#### Action:

Selects Blind display mode  
Prompt reads:  
**Select cue number**  
**To select cue type, press TYPE**

Selects cue 2

Selects channels 13 and 15  
Prompt reads:  
**Select channel numbers**

Sets channels at full intensity level

Prompt reads:  
**To record cue, select number and press ENTER**  
**To cancel, press CLEAR**

Records cue 2 with channels 13 and 15 at Full

*a. Note that when using [Full], you do not have to press [At] first.*

When you record the cue, channel levels set by a fader change from red (indicating a channel level set on the keypad) to colors based on the channels' level movements from cue to cue.<sup>12</sup>

---

<sup>12.</sup> See [Navigation and visual feedback, page 3](#), for more information on what channel level colors mean.



## ***Recording a cue with a single fade time***

Unless you tell it otherwise, the console assigns default fade times to any cue you record. If you prefer, you may record cues with custom fade times instead.

Fade times can be zero seconds to 99:59 minutes long. They may be expressed in minutes and seconds, or as fractions of seconds (in decimal format). Acceptable time values include: 0.2 (.2 seconds), 00:12 (12 seconds), 5.5 (5.5 seconds), or 5:30 (five minutes, 30 seconds).

Follow these steps to record a cue with a custom fade time:

<b>Keystrokes:</b>	<b>Action:</b>
1. Press [Stage] or [Blind].	Selects display mode
2. Press [Cue].	Prompt reads: <b>Select cue number</b> <b>To select cue type, press TYPE</b>
3. Press [3].	Selects cue 3
4. Press [Time].	Prompt reads: <b>Enter upfade time</b>
5. Press [8].	Enters a fade time of 8 seconds. Corner reads: <b>UpTime 8</b>
6. Press [Enter] [Enter].	Enters matching downfade time
7. Press [Record]. <sup>a</sup>	Prompt reads: <b>To record cue, select number and press ENTER</b> <b>To cancel, press CLEAR</b>
8. Press [Enter].	Records cue 3 with fade time of eight seconds

*a. If the cue already exists, you may omit steps 7 and 8.*

## ***Recording a cue with split fade times***

The console allows you to record cues with different upfade and downfade times. These cues are said to have *split* fade times. On the console's display, the time to the left of the "/" refers to the upfade time; the number to the right refers to the downfade time.

Follow these steps to record a cue with split upfade and downfade times:

<b>Keystrokes:</b>	<b>Action:</b>
1. Press [Stage] or [Blind].	Selects display mode
2. Press [Cue].	Prompt reads: <b>Select cue number</b> <b>To select cue type, press TYPE</b>
3. Press [4].	Selects cue 4 Corner reads: <b>Cue 4</b>
4. Press [Time].	Prompt reads: <b>Enter upfade time</b>
5. Press [1][0].	Enters an upfade time of ten seconds Corner reads: <b>UpTime 10</b>
6. Press [Enter].	Prompt reads: <b>Enter downfade time</b>
7. Press [1][5].	Enters a downfade time of 15 seconds Corner reads: <b>DnTime 15</b>
8. Press [Record]. <sup>a</sup>	Prompt reads: <b>To record cue, select number and press ENTER</b> <b>To cancel, press CLEAR</b>
9. Press [Enter].	Records cue 4 with upfade time of ten seconds and downfade time of 15 seconds

*a. If the cue already exists, you may omit steps 8 and 9.*

## ***Recording a cue with a wait time***

Wait time is the time that elapses between when you press [Go] and when the actual fade begins. You can record cues with a wait time of up to 99:59 minutes.

Wait time may be entered in normal time format or in decimal format. When entered with a decimal point, the number must be less than one minute (0.1 to 59.9 seconds) to be accepted. When entered without a decimal point, a 2-digit number will be treated as seconds if less than 60 and as a calculated value of minutes and seconds if between 60 and 99. For example, if you enter 70, the time will display as 1:10. If you enter either a 3-digit or a 4-digit number, the last two digits, up to 59, are interpreted as seconds. For example, if you enter 9930, the time will display as 99:30.

The console allows you to program a wait time for either the upfade or the downfade; not both. You can see which type of wait you have in the Wait field of the Attribute Bar. If an upwait, a small up arrow (↑) is shown next to the time. If a downwait, a down arrow (↓) is shown instead. If you do not enter a wait time, the console assigns the cue a wait time of zero.

Follow these steps to change the upfade and/or downfade wait time.

<b>Keystrokes:</b>	<b>Action:</b>
1. Press [Stage] or [Blind].	Selects display mode
2. Press [Cue].	Prompt reads: <b>Select cue number</b> <b>To select cue type, press TYPE</b>
3. Press [5]	Selects cue 5
4. Press [Wait] once or... Press [Wait] twice.	Prompt reads: <b>Enter upfade wait time</b> or... <b>Enter downfade wait time.</b>
5. Press [6].	Enters a wait time of six seconds Corner reads: <b>UpWait 6</b> or... <b>DnWait 6</b>
6. Press [Enter].	Records cue 5 with wait time of six seconds

## Recording cues with Link and Follow

When you record a cue, it automatically becomes part of the Cue List. The Cue List is a list of all cues, organized in numeric sequence. Normally, when you press [Go] to execute cues, the console plays them back in the sequence in which they appear in the Cue List. [Link] allows you to modify the sequence in which cues play back. [Follow] allows you to play back multiple cues automatically.

### Link

[Link] allows you to play back cues out of sequence by linking them together. If you link cue 10 to cue 1, then cue 10 follows cue 1.

Follow these steps to record a linked cue.<sup>13</sup>

Keystrokes:	Action:
1. Press [Stage] or [Blind].	Selects display mode
2. [Cue] [1].	Selects cue 1
3. Press [Link].	Prompt reads: <b>To link to cue, select cue number</b> <b>To link to macro, press ENTER</b> <b>MACRO</b>
4. Press [1][0] [Enter]. <sup>a</sup>	Links cue 10 to cue 1. After you play cue 1, press [Go] to playback cue 10

*a. Press [Clear] in this step to remove an existing link.*

---

<sup>13.</sup> You can also link macros to cues. For more information, see [Linking a macro to a cue, page 91](#).

## **Follow**

[Follow] allows you to play a series of cues automatically. The [Follow] time indicates how long the console waits after the cue starts before the next cue runs. [Follow] plays back the next cue on the Cue List unless you use [Link] to specify a different sequence.

Follow times may be expressed in minutes and seconds, or as fractions of seconds, up to 99:59 minutes.

Follow these steps to record a cue with [Follow].

<b>Keystrokes:</b>	<b>Action:</b>
1. Press [Stage] or [Blind].	Selects display mode
2. Press [Cue] [7].	Selects cue 7 Prompt reads: <b>Select cue number</b> <b>To select cue type, press TYPE</b>
3. Press [Follow].	Prompt reads: <b>Enter follow time (or press ENTER to confirm default time (Press CLEAR to cancel follow time)</b>
4. Press [5] [Enter]. <sup>a</sup>	Records cue 7 with a Follow time of five seconds. After you start cue 7, the next cue in the Cue List plays automatically five seconds later

*a. Press [Clear] in this step to remove an existing follow time.*

## **Create playback loops with Link and Follow**

You can use Link and Follow to create cue playback loops in which a group of cues play back automatically and repeat.<sup>14</sup>

Stop a loop that was created by Link and Follow by pressing GO after the loop has played through at least one time. If you press GO before the loop plays through, you will only advance to the next cue in the loop sequence. If you press GO after it plays through at least one time, you temporarily override the Link sequence and advance instead to a non-loop cue. The non-loop cue that would play is the next one in order after the linked cue. For example, if cue 6 is linked to cue 10 in a loop, the non-loop cue played when you stop the loop would be cue 7.

Follow these steps to create a five-cue loop:

<b>Keystrokes:</b>	<b>Action:</b>
1. Create five cues numbered 1, 2, 3, 4, and 5.	Cue list displays cues 1 through 5
2. Press [Cue], then press [1], the number of the first cue you want to include in the playback loop.	Selects the first cue
3. Press [Follow] [5] [Enter].	Assigns a follow time of five seconds to the first cue
4. Repeat steps 2 and 3 for cues 2 through 5.	Assigns a follow time of five seconds to the remaining cues
5. Press [Cue], then press [5], the number of the last cue in the playback loop.	Selects the last cue in the playback loop
6. Press [Link], then press [1], the number of the first cue in the playback loop. Press [Enter].	Creates a loop by linking the last cue to the first cue

---

<sup>14</sup>. You may also use effects to create loops. See [Chapter 16 Effects](#) for more information.

## ***Linking a macro to a cue***

[Link] allows you to automatically run a macro when a cue runs. If you link macro 6 to cue 1, then macro 6 runs when you play cue 1. If you want the macro to delay before running, one way is to start the macro with a Macro Wait of the desired length.<sup>15</sup> You can also delay the macro by assigning a follow time to the cue.<sup>16</sup>

Follow these steps to link a macro to a cue:

<b>Keystrokes:</b>	<b>Action:</b>
1. Press [Stage] or [Blind].	Selects display mode
2. [Cue] [1].	Selects cue 1
3. Press [Link].	Prompt reads: <b>To link to cue, select cue number</b> <b>To link to macro, press ENTER</b> <b>MACRO</b>
4. Press [Enter Macro].	Prompt reads: <b>To link to macro, select macro number</b> <b>To link to cue, press CUE</b>
5. Press [7] [Enter].	Records macro 7 linked to cue 1. When you press [Go] to play cue 1, macro 7 will run at the same time

---

<sup>15.</sup> See [Chapter 18 Macros](#) for information about creating macros.

<sup>16.</sup> See [Recording cues with Link and Follow, page 88](#).

## ***Recording a cue using Solo***

Solo is useful for setting existing channels to zero temporarily while you view or record selected channels. You can use Solo in Blind or Stage. When used in Stage, you can use solo to cut all lights except those selected, thus using it to identify specific lights. Or, you can use Solo a different way to cut all channels except those selected, which is a way of filtering channels for recording. Both procedures are given below.

### ***Using Solo to record selected lights***

In the Stage procedure below, all but selected lights are cleared the first time you press Solo. They are restored as before when you press Solo a second time (Stage only). This use of Solo will not NOT clear independent channels, such as those controlling most moving light attributes. It will, however, clear the intensity channel of a moving light fixture.

<b>Keystrokes:</b>	<b>Action:</b>
1. Press [Stage].	Selects the Stage display mode
2. Press [Cue] [1][0] [Go].	Plays cue 10 in a fader pair to set a look on stage
3. Press [2][0] [Thru] [3][0].	Selects channels 20 through 30
4. Press [S7], <b>More Softkeys</b> , until [S3] reads <b>Solo</b> .	
5. Press [S3], <b>Solo</b> .	Sets all channels other than 20 through 30 to zero Prompt reads: <b>To clear all channel levels, press SOLO</b>
6. Press [2][0] [Thru] [3][0] [Full].	Selects channels 20 through 30 and sets them to full
7. Press [Record] [Cue] [7] [Enter].	Records channels 20 through 30 into cue 7
8. Press [S3], <b>Solo</b> .	Restores the channels that were cleared by Solo

### ***Using Solo as a pre-recording filter***

The following procedure, which has an equivalent in Blind, uses Solo to restrict the recording to selected channels, clearing all others whether independent or not. Stage levels are unaffected by this procedure.

<b>Keystrokes:</b>	<b>Action:</b>
1. Press [Stage].	Selects the Stage display mode
2. Press [Cue] [1][0] [Go].	Plays cue 10 in a fader pair to set a look on stage
3. Press [Chan] [2][0] [Thru] [3][0] [Full].	Selects channels 20 through 30 and sets them to full
4. Press [Record] [Cue] [7] [Solo].	Records selected channels into cue 7



## Labeling cues

If you have Expression Off-Line, you may assign labels to your cues.<sup>17</sup> Labels can consist of any combination of letters, numbers and symbols and may be up to 16 characters long.

Follow these steps to label a cue:

- | <b>Keystrokes:</b>   | <b>Action:</b>   |
|--|--|
| 1. Press [Stage] or [Blind].   | Selects display mode   |
| 2. Press [Cue] [1][2] [Label]. <sup>a</sup>  | Selects Cue 12<br>Prompt reads:<br><b>Type cue label</b><br><b>(F6 = clear to end,</b><br><b>F7 = last cue label,</b><br><b>F8 = next cue label)</b> |
| 3. Use the alphanumeric keyboard to type the desired label. For example, call cue 12 "Toad exits." | Enters cue label<br>Corner reads: <b>Label Toad exits</b>  |
| 4. Press [Enter]. <sup>b</sup>   | Records Cue 12 with label "Toad exits"   |

*a. The Label key is not available on the Express console. You may type keyboard equivalent "B" in Expression Off-Line as a substitute for the Label key.*

*b. If the cue did not previously exist, press [Record] [Enter] in step 4. This will create the cue and label, all in one step.*

---

<sup>17.</sup> For information about Expression Off-Line and how to order it, see [Expression Off-Line, page 306](#).

## ***Modifying a recorded cue live***

Previous examples in this chapter illustrated how to record new cues. If you want to modify channels in a recorded cue, you can play back the cue in Stage, make the changes, and then re-record the cue.<sup>18</sup> The modifications immediately affect the look on stage. You can also record the live look you created to another cue.

### ***Modifying channels in a cue***

Add new channels or modify channel levels with the procedure given below. You can use all the same techniques for channel or fixture selection or for setting levels that are available to you for initial cue recording.

#### **Keystrokes:**

1. Press [Stage].
2. Press [Cue], enter cue number and press [Go].
3. Select channels and set channel levels to make the desired changes to the cue.
4. Press [Record] [Enter].<sup>a</sup>

#### **Action:**

- Selects Stage display mode
- Plays back selected cue
- Selects channels, which can be the same as those already in the cue or additional ones, and set levels
- Re-records cue with desired modifications

- a. *Insert a different cue number between [Record] and [Enter] in this step to record the look to another cue. When you record to another cue, the modifications are not reflected in the fader. If you don't want to lose the look from stage, run the cue through a fader before you release channels.*

---

<sup>18</sup>. *If you are not familiar with procedures for playing back cues, see [Chapter 10 Playing back cues, page 119](#).*

## ***Modifying cue attributes***

If all you want to do is modify a cue attribute, such as cue timing, you can do that in Stage without first playing back the cue. Use the procedure below to modify cue attributes.

### **Keystrokes:**

### **Action:**

1. Press [Stage] or [Blind].      Selects display mode
2. Press [Cue] then enter the number of the desired cue.      Selects the desired cue
3. Press the key that corresponds to the attribute you want to modify. Options include: Type, Time, Wait, Link Follow.
4. Enter the new setting for the attribute.      Modifies cue attribute
5. Press [Enter].<sup>a</sup>      Re-records cue with modifications

*a. Note that if you change the cue's type, press [Record] [Enter] in step 5. Type changes will not take effect unless recorded.*

## Updating cues

Update allows you to modify previously recorded cues, groups, submasters or focus points in Stage. Update takes levels from all captured and selected channels, and those selected may be restricted with the Only command.<sup>19</sup>

### Updating an active cue

The following procedure illustrates how to update a cue that has been played back.

Keystrokes:	Action:
1. Press [Stage].	Selects Stage display mode
2. Press [Cue], enter cue number and press [Go].	Plays back selected cue, bringing up its current levels
3. Modify channel levels as desired.	Sets cue levels or selects additional channels and sets their levels
4. Press [S2], <b>Update</b> .	Prompt reads: <b>To update cue, select number and press ENTER (TRACK + ENTER for tracking) To cancel, press CLEAR</b>
5. To restrict channels in the update, use Only here. <sup>a</sup>	Selects channels to update Prompt reads: <b>Select channel numbers To cancel, press CLEAR</b>
6. Press [Enter]. <sup>b</sup>	Updates the active cue

*a. Optional step.*

*b. If you want the update to track into subsequent cues, press [Track] before pressing enter.*

---

<sup>19</sup> For an explanation of captured channels, see [Channel modes, page 52](#). For an explanation of Only, see [The Only command, page 8](#).

## ***Updating a recorded cue***

You need not play back the cue to update it. The following procedure illustrates how to update any recorded cue.

<b>Keystrokes:</b>	<b>Action:</b>
1. Press [Stage].	Selects Stage display mode
2. Press [S8], <b>Fixture</b> , [1] [Thru] [8], [Full].	Selects fixtures 1 through 8 and sets their intensities to full
3. Set the pan and tilt levels. <sup>a</sup>	Sets the levels of the position attributes for all selected fixtures
4. Press [S2], <b>Update</b> , [3].	Selects cue 3 to update Prompt reads: <b>To update cue, select number and press ENTER (TRACK + ENTER for tracking) To cancel, press CLEAR</b>
5. Press [Only] [S8], <b>Fixture</b> , [6] and [7]. <sup>b</sup>	Restricts the update to fixtures 6 and 7 Prompt reads: <b>Select fixture number(s) To cancel, press CLEAR</b>
6. Press [Enter]. <sup>c</sup>	Updates cue 3

*a. Use your trackpad.*

*b. Optional step. If you don't use Only, all non-zero channels are included in the update.*

*c. If you want the update to track into subsequent cues, press [Track] before pressing enter.*

## Using Update to modify fade rate

You may also use the Update function to record manually modified fade rates into cues.

Follow these steps to update a rate for a cue running in a fader:

<b>Keystrokes:</b>	<b>Action:</b>
1. Press [Rate] key for the fader in which the cue is running.	Activates rate control
2. Move rate wheel to adjust fade rate.	Fades are placed under control of the rate wheel. The Fader Status window shows the current rate
3. Press [S2], <b>Update</b> .	Prompt reads: <b>To update cue, select number and press ENTER (TRACK + ENTER for tracking) (Press ONLY + ENTER to update only those channels already in cue)</b>
4. Press [Enter].	New rate is recorded into cue

## Deleting cues

You can delete a cue in either Blind or Stage. Follow the procedure below to delete a cue in Blind. Follow the same procedure in Stage except press [S7], **More Softkeys**, after pressing [Stage] to display the **Delete** key as softkey [S6].

<b>Keystrokes:</b>	<b>Action:</b>
1. Press [Blind].	Selects Blind mode
2. Press [S6], <b>Delete Cue</b> .	Prompt reads: <b>To Delete cue, press ENTER - Delete cue and tracking, press TRACK + ENTER</b> <b>To cancel, press CLEAR</b>
3. Enter number of cue to delete. <sup>a</sup>	Selects cue to delete
4. Press [Enter]. <sup>b</sup>	Prompt reads: <b>To confirm, press ENTER</b> <b>To cancel, press CLEAR</b>
5. Press [Enter].	Deletes cue

*a. Optional if deleting the currently selected cue.*

*b. To delete the cue and any channels that track, press [Track] before [Enter]. For more information on tracking, see [Chapter 8 Track](#).*

## Copying cues

You may want to use a cue's channel levels as the foundation for a new cue, group or submaster.<sup>20</sup> Use the following procedure to perform a copy operation. This copy may be performed either in Blind or in Stage.

To copy a cue to another cue in Stage, follow the procedure below. If copying in Blind rather than in Stage, omit step 3 from this procedure.

### Keystrokes:

1. Press [Stage].
2. Press [Cue] [1].
3. Press [Go].
4. Press [Record].
5. Press [2].<sup>a</sup>
6. Press [Enter].

### Actions:

Selects the Stage display

Prompt reads:

**Select cue number**

**To select cue type, press TYPE**

Prompt reads:

**To record cue, select number and press ENTER**

**To cancel, press CLEAR**

Corner reads: **Cue 2**

Cue copy is complete. Channel levels have been copied from cue 1 to cue 2. You can now modify the new cue

- a. Press [Sub] or [Group] before the number in step 5 if you want to copy a look from a cue to a submaster or a group.*

---

<sup>20</sup> You cannot copy an effect cue to a group.

## ***Inserting cues***

You may want to insert a cue between recorded cues. For example, you may want to modify cue 1 slightly and insert it between cues 1 and 2. You can number cues with a one-digit decimal. Therefore, you can insert up to nine cues between 1 and 2 (1.1, 1.2, etc.).

Follow these steps to insert a cue between existing cues:

### **Keystrokes:**

### **Action:**

1. Press [Blind] or [Stage].  
Selects display mode
2. Press [Cue] and enter the number of the cue to modify, then press [Enter].  
Selects the desired cue
3. If you are working in Stage mode, press [Go].  
Brings up cue on stage and on the display
4. Add or modify channels and cue attributes.  
Cue is modified
5. Press [Record].  
Prompt reads:  
**To record cue, select number and press ENTER**  
**To cancel, press CLEAR**
6. Enter cue number with a decimal to insert it between cues (e.g., [1].[5]). If you do not enter a new cue number, you will overwrite the existing cue.  
Corner reads: **Cue 1.5**
7. Press [Enter].  
New cue 1.5 is recorded between cues 1 and 2



# Chapter 8

## Track

### **Track record function**

Track record is a way of recording new cues or modifying existing ones when you want certain channels or channel levels to continue unchanged in playback from cue to cue. Levels recorded into a tracked cue continue unchanged in subsequent cues until a new level is encountered. Track record gives you the power to modify a range of cues automatically by changing just the first in the sequence.<sup>21</sup> You can also use track record for new cue recording to pull levels from the previous cue into the new cue.

---

<sup>21</sup>. **WARNING:** This procedure although automatic can be time-consuming. Attempting it while running a show could have serious consequences.

## Track record

When you record a series of cues, you typically record the first cue, then build the second cue from the first. Some of the channels change, but many remain the same. The third cue is built from the second and so on. This procedure results in many channels being set to a level in one cue and staying at that level for several cues.

A channel whose level does not change through a series of consecutive cues is said to “track” from cue to cue. That same sequence of unchanged levels is also referred to as a “track.” The [Track] key in Blind tracks into the new cue by pulling channel levels from the previous cue. In Stage or Blind, the [Track] key adds tracks to subsequent cues.

The following examples demonstrate how Track works. They include five cues, each with five channels. In these examples, when a channel changes level from one cue to the next it is printed in **bold**; tracked channels are printed normally. This corresponds to how Blind displays levels – channels that rise or fall are displayed in blue or green; tracked channels are displayed in purple.

### Using record to create tracks

Use the following keystrokes in Stage to create the five cues illustrated below (see [Recording a cue in Stage, page 83](#)). Each cue adds channels to the previous cue.

```
Cue 1 [1] [Full] [Record] [1] [Enter]
Cue 2 [2] [Full] [Record] [2] [Enter]
Cue 3 [3] [Full] [Record] [3] [Enter]
Cue 4 [1] [At] [2][5] [4] [Full] [Record] [4] [Enter]
Cue 5 [1] [Thru] [4] [At] [0][0] [Record] [5] [Enter]
```

These keystrokes produce the results shown in the following illustration. Notice the channel tracks that develop as a channel remains at the same level through a number of cues. For example, channel 1 tracks from cue 1 to cue 3.<sup>22</sup>

---

	Chan 1	Chan 2	Chan 3	Chan 4	Chan 5
Cue 1	<b>FF</b>				
Cue 2	FF	<b>FF</b>			
Cue 3	FF	FF	<b>FF</b>		
Cue 4	<b>25</b>	FF	FF	<b>FF</b>	
Cue 5	<b>00</b>	<b>00</b>	<b>00</b>	<b>00</b>	

---

---

<sup>22</sup>. When a channel is not set at any level (such as channel 5 above) it is considered tracked at clear.

## Recording modified cues

The difference between Record and Track is apparent when you modify a cue or insert a new cue between two existing cues. Record and Track produce different results.

### Using Record

The following keys were pressed to release captured channels and play back cue 1.

#### Keystrokes:

1. Press [Stage] [Rel] [Rel].
2. Press [Cue] [1] [Go].
3. Press [1] [At] [5][0].
4. Press [Record].
5. Press [Enter].

#### Actions:

Releases captured channels  
Prompt reads:

**Select channel numbers**

Plays back cue 1

Modifies channel 1

Prompt reads:

**To record cue, select number and  
press ENTER**

**To cancel, press CLEAR**

Records cue 1

With cue 1 in a fader, channel 1 is modified to 50 percent. Because cue 1 is re-recorded with [Record], none of the subsequent cues are affected by the procedure.

Following is an illustration of the use of [Record] when modifying cue 1. Note that channel 1 is not affected in cues 2 and 3. Also note that when you record a modified cue that is in a playback fader, the changes are reflected in the fader. That is, when you release the channels you have modified, they remain on stage.

---

	Chan 1	Chan 2	Chan 3	Chan 4	Chan 5
Cue 1	<b>50</b>				
Cue 2	<b>FF</b>	<b>FF</b>			
Cue 3	FF	FF	<b>FF</b>		
Cue 4	<b>25</b>	FF	FF	<b>FF</b>	
Cue 5	<b>00</b>	<b>00</b>	<b>00</b>	<b>00</b>	

---

## Using Track

If you have tracked channels (all with the same level), you can make them track at a different level. Also, you can track channels at a focus point, but you cannot track through a channel set at a focus point. To illustrate, suppose you have tracked channels as shown in the example under [Using record to create tracks, page 102](#). In that example, channel 1 is tracked at full through cues 1-3. Change the tracked level of channel 1 in those cues with the following procedure:

### Keystrokes:

1. Press [Stage] [Rel] [Rel].
2. Press [Cue] [1] [Go].
3. Press [1] [At] [5][0].
4. Press [Track].
5. Press [Enter].

### Actions:

- Releases captured channels  
Prompt reads:  
**Select channel numbers**
- Plays back cue 1
- Modifies channel 1
- Prompt reads:  
**To record cue & tracking, select number and press ENTER**  
**To cancel, press CLEAR**
- Re-records cue 1 and tracks channel 1 into subsequent cues

The results of using Track rather than Record are illustrated below. The modified level is recorded in the current cue and carries through cues 2 and 3 until stopped at cue 4, where the level is different.

---

	Chan 1	Chan 2	Chan 3	Chan 4	Chan 5
Cue 1	<b>50</b>				
Cue 2	50	<b>FF</b>			
Cue 3	50	FF	<b>FF</b>		
Cue 4	<b>25</b>	FF	FF	<b>FF</b>	
Cue 5	<b>00</b>	<b>00</b>	<b>00</b>	<b>00</b>	

---

## Inserting cues

If you insert a cue in this sequence, Record and Track produce different results. Record saves changes only in the cue you insert while Track saves the changes you make and tracks them through the following cues.

The example given below is in Stage. You can get the same results in Blind but with the additional advantage that you can pull channels from the immediately previous cue. An illustration of pulling channels when inserting a cue is given after the comparison between Record and Track in Stage.

### Using Record

The following keys were pressed to release captured channels and play back cue 1. With cue 1 in a fader, channel 4 is added at 50 percent. The new look is inserted as cue 1.1.

#### Keystrokes:

1. Press [Stage] [Rel] [Rel].
2. Press [Cue] [1] [Go].
3. Press [4] [At] [5][0].
4. Press [Record].
5. Press [1][.][1] [Enter].

#### Actions:

Releases captured channels  
Prompt reads:

**Select channel numbers**

Plays back cue 1

Modifies channel 4

Prompt reads:

**To record cue, select number and  
press ENTER**

**To cancel, press CLEAR**

Records cue 1.1

The following diagram illustrates what happens when you insert cue 1.1 using [Record]. Note that the channel in cue 1.1 is not added to the cues that follow it. In fact, that channel is faded out when cue 2 is played.

---

	Chan 1	Chan 2	Chan 3	Chan 4	Chan 5
Cue 1	<b>50</b>				
Cue 1.1	50			<b>50</b>	
Cue 2	50	<b>FF</b>		<b>00</b>	
Cue 3	50	FF	<b>FF</b>		
Cue 4	<b>25</b>	FF	FF	<b>FF</b>	
Cue 5	<b>00</b>	<b>00</b>	<b>00</b>	<b>00</b>	

---

## Using Track

When you insert a cue with Track, new channels track through the following cues until the console encounters a cue with a level previously recorded for that channel.

The following procedure illustrates this use of Track, and the following illustration shows what results. Note that the channel in the new cue is tracked into subsequent cues until a pre-recorded level stops it.

### Keystrokes:

1. Press [Stage] [Rel] [Rel].
2. Press [Cue] [1] [Go].
3. Press [4] [At] [5][0].
4. Press [Track].
5. Press [1][.][1] [Enter].

### Actions:

- Releases captured channels  
Prompt reads:  
**Select channel numbers**
- Plays back cue 1
- Modifies channel 4
- Prompt reads:  
**To record cue & tracking, select number and press ENTER**  
**To cancel, press CLEAR**
- Records cue 1.1 and tracks for channel 4 through subsequent cues

---

	Chan 1	Chan 2	Chan 3	Chan 4	Chan 5
Cue 1	<b>50</b>				
Cue 1.1	50			<b>50</b>	
Cue 2	50	<b>FF</b>		50	
Cue 3	50	FF	<b>FF</b>	50	
Cue 4	<b>25</b>	FF	FF	<b>FF</b>	
Cue 5	<b>00</b>	<b>00</b>	<b>00</b>	<b>00</b>	

---

## ***Pulling channels in Blind***

If you insert in Blind using [Track], you can get a start on a new cue by using levels already defined in the previous cue. You can then add channels or modify levels in the new cue. From that point on, you can use either [Record] or [Track] analogously to the procedures explained above, depending upon whether or not you want the channels in the inserted cue to track into subsequent cues.

Press the following keys to insert cue 2.5 in Blind by pulling in levels from previous cue 2.0 and adding channel 5 at 70 percent. Note that the new cue in this example will track into subsequent cues as well because of the second use of [Track] in step 5.

### **Keystrokes:**

1. Press [Blind] [2][.][5].
2. Press [Track] [Enter].
3. Press [Channel] [5] [At] [5][0].
4. Press [Track].
5. Press [Enter].

### **Actions:**

- Displays empty cue 2.5  
Prompt reads:  
**Select cue number**  
**To select cue type, press TYPE**
- Pulls in previous cue's channels
- Adds channel 5 at 50 percent  
Prompt reads:  
**Select channel numbers**
- Prompt reads:  
**To record cue & tracking, select number and press ENTER**  
**To cancel, press CLEAR**
- Records cue 2.5

The following illustration shows this insertion and subsequent tracking.

---

	Chan 1	Chan 2	Chan 3	Chan 4	Chan 5
Cue 1	<b>50</b>				
Cue 2	50	<b>FF</b>		<b>00</b>	
Cue 2.5	50	FF		00	<b>70</b>
Cue 3	50	FF	<b>FF</b>		70
Cue 4	<b>25</b>	FF	FF	<b>FF</b>	70
Cue 5	<b>00</b>	<b>00</b>	<b>00</b>	<b>00</b>	70

---

## ***Blackout cues and tracking***

Sometimes you may add a channel to a sequence of cues that have not used that channel yet. For example, you may want to add a channel to all cues in a scene. To do this, add the channel to the first cue in the sequence and use Track to track the change through the remaining cues.

However, the last cue in sequence may be a blackout cue. When you track the channel, the new channel tracks until it runs into a different recorded level. To ensure that channels are not tracked through a blackout cue, make the blackout cue an allfade cue. An allfade cue assigns a level of zero to any unused channels. This blocks any potential tracks. An allfade cue also clears the opposite fader.

Figure 6 displays what happens when we track channel 5 through the sequence when cue 5 is a regular crossfade cue.

---

	Chan 1	Chan 2	Chan 3	Chan 4	Chan 5
Cue 1	<b>50</b>				<b>FF</b>
Cue 1.1	50			<b>50</b>	FF
Cue 2	50	<b>FF</b>		<b>00</b>	FF
Cue 3	50	FF	<b>FF</b>		FF
Cue 4	<b>25</b>	FF	FF	<b>FF</b>	FF
Cue 5	<b>00</b>	<b>00</b>	<b>00</b>	<b>00</b>	FF

---

*Figure 6*

Channel 5 tracks through cue 5 and ruins the blackout cue.



If cue 5 is an allfade, the console records all unused channels at 00 percent. In the example below, an allfade enters 00 in channel 5, cue 5. When you track channel 5 through the sequence, it won't track through the blackout cue.

To select the allfade type for cue 5, enter these keystrokes:

[Blind] [5] [Type] [2]Selects allfade fade type.  
 [Record] [Enter]Re-records cue.

Now when we track channel 5 through the sequence, cue 5 blocks the track. The result is illustrated in Figure 7.

---

	Chan 1	Chan 2	Chan 3	Chan 4	Chan 5
Cue 1	<b>50</b>				<b>FF</b>
Cue 1.1	50			<b>50</b>	FF
Cue 2	50	<b>FF</b>		<b>00</b>	FF
Cue 3	50	FF	<b>FF</b>		FF
Cue 4	<b>25</b>	FF	FF	<b>FF</b>	FF
Cue 5	<b>00</b>	<b>00</b>	<b>00</b>	<b>00</b>	<b>00</b>

---

*Figure 7*

For more information on cue fade types, see [Cue types, page 80](#).



# *Chapter 9*

## *Multipart cues*

A multipart cue consists of up to eight parts, each of which is essentially an independent cue with its own channel levels and timing information. You may set the upfade, downfade and wait times for each part of a multipart cue. Create a cue as a multipart cue or record it first as a standard, one-part cue and then split it later into parts.

Each part of a multipart cue may consist of any number of channels, but a channel may only be included in one part of a multipart cue. If you record a channel in a part and that channel is already included in another part, the channel will be placed in the new part and be removed from the older part automatically.

Wait times in multipart cues allow you to program fades that do not start immediately when you play the multipart cue. When you press [Go] to start a multipart cue, some parts may start immediately and others may start up to 99:59 minutes later, depending on the assigned wait time. The total duration of a multipart cue is equal to the combined wait and fade times of the longest part.

When you display a multipart cue, channel levels that are higher than they were in the previous cue are displayed in blue; channel levels that are lower than they were in the previous cue are displayed in green; and channel levels that are unchanged from the levels in the previous cue are displayed in purple. When a part is selected, channel colors remain the same in that part but channels in other parts are grayed.

Multipart cues can be recorded in either Stage or Blind mode. They are stored like normal cues in the console's memory and on disk.

This chapter includes the following sections:

- Recording a multipart cue
- Converting a standard cue to a multipart cue
- Wait times in multipart cues
- Editing a multipart cue

## Recording a multipart cue

In the procedure below, one or more parts are recorded to a cue. The maximum number of parts you may record to a cue is eight. Follow, Link and Label attributes may be assigned to the overall cue.

### Keystrokes:

1. Press [Stage].
2. Press [S7], **More Softkeys**, until **Part** appears as softkey [S1].
3. Select channels, enter channel levels and press [Enter].
4. Press [Record].
5. Enter the cue's number followed by [Enter].<sup>a</sup>
6. Press [S1], **Part**.
7. Enter the number of the part you want to record, followed by [Enter].<sup>b</sup>
8. Press [Rel] [Rel].
9. Repeat steps 2 through 8, adding channels for each part you want to include in the multipart cue.

### Action:

- Selects Stage display mode
- Finds the Part softkey
- Prompt reads:  
**Select channel numbers**
- Prompt reads:  
**To record cue, select number and press ENTER**  
**To cancel, press CLEAR**

- Indicates the selected cue as a multipart cue
- Prompt reads:  
**Select part number to record**  
**To cancel, press CLEAR**

- Records the part
- Prompt reads:  
**Select channel numbers**

- Releases captured channels

- Records subsequent parts.

*a. If recording several parts to the same multipart cue, you do not need to enter the cue number for subsequent parts after recording the first part.*

*b. You may select any part number in the range 1-8, regardless of previous parts recorded for this cue.*

## ***Converting a standard cue to a multipart cue***

If you have already created a single-part cue, the console allows you to reconfigure it as a multipart cue. You can convert a standard cue to a multipart cue in either Stage or Blind mode, but it's easier in Blind because levels are highlighted.

Once you create the first part, all channels not assigned to that part are automatically assigned to part 8. As you create additional parts from channels in part 8, they are deleted from part 8 and added to the selected part.

Follow these steps to convert cue 1, assumed to be a standard cue, to a multipart cue. This example is in Blind. To perform the equivalent procedure in Stage, run the cue in the faders before preceding with step 3.

<b>Keystrokes:</b>	<b>Action:</b>
1. Press [Blind].	Selects [Blind] display
2. Press [Cue] [1].	Selects cue 1
3. Press [Channel] and select the channels for a part. <sup>a</sup>	
4. Press [S7], <b>More Softkeys</b> , until <b>Part</b> appears as softkey [S1].	Finds the Part softkey
5. Press [S1], <b>Part</b> , followed by the part's number and then [Enter].	Creates the designated part.
6. Repeat steps 3-5 to create the other parts, as desired.	Creates more parts for this cue.

*a. If in Stage, selection defaults to channels so you do not need to press [Channel].*

## ***Wait times in multipart cues***

You can set individual wait times of up to 99:59 minutes for each part of a multipart cue. The wait time is the delay between when you press [Go] and when the part begins. If no wait is recorded, all parts run simultaneously when you press [Go].

Follow these steps to assign a wait time to a part:

<b>Keystrokes:</b>	<b>Action:</b>
1. Press [Cue], then enter the cue number.	Selects cue number Prompt reads: <b>Select cue number</b>
2. Press [S7], <b>More Softkeys</b> , until <b>Part</b> appears as softkey [S1].	Finds the Part softkey
3. Press [S1], <b>Part</b> , then enter the part number.	Selects part number Prompt reads: <b>Select part number</b>
4. Press [Wait] [1][0].	Selects wait time of ten seconds Prompt reads: <b>Enter wait time</b>
5. Press [Enter].	Sets wait time for the part to ten seconds. Part will wait ten seconds, then run

## Editing a multipart cue

Once you have created a multipart cue, you can add or delete parts, add or delete channels from the parts, change channel levels, or change fade and wait times. Except for Update, all multipart cue editing is done in Blind.

### Deleting a part from a multipart cue

Deleting a part from a multipart cue is the reverse of creating a multipart cue from a standard cue. When a part is deleted, the channels in the deleted part do not leave the cue but transfer to part 8, where they can be reassigned if desired. Channel levels are unaffected.

Follow these steps to delete part 1 from a multipart cue in Blind:

<b>Keystrokes:</b>	<b>Action:</b>
1. Press [Blind].	Selects Blind display mode
2. Press [Cue] [4].	Selects the cue
3. Press [S7], <b>More Softkeys</b> , until <b>Part</b> appears as softkey [S1].	Finds the Part softkey
4. Press [S1], <b>Part</b> , [1].	Selects the part
5. Press [S6], <b>Delete Part</b> .	Prompt reads: <b>To delete part, press ENTER – Delete part &amp; tracking, press TRACK + ENTER</b> <b>To cancel, press CLEAR</b>
6. Press [Enter]. <sup>a</sup>	Prompt reads: <b>To confirm, press ENTER</b> <b>To cancel, press CLEAR</b>
7. Press [Enter].	Deletes part 1 from cue 4

*a. If the part to be deleted has tracking channels and you want those tracking channels removed from subsequent cues, press [Track] before [Enter].*

## ***Adding, deleting and modifying channels***

Follow these steps to edit channels in a multipart cue:

<b>Keystrokes:</b>	<b>Action:</b>
1. Press [Blind].	Selects Blind display mode
2. Enter the cue number.	Prompt reads: <b>Select cue number</b> <b>To select cue type, press TYPE</b>
3. Press [S7], <b>More Softkeys</b> , until <b>Part</b> appears as softkey [S1].	Finds the Part softkey
4. Press [S1], <b>Part</b> , then press [+] or [-] until the desired part is displayed.	Prompt reads: <b>Select part number</b>
5. Press [Channel], and select the desired channels.	Prompt reads: <b>Select channel numbers</b>
6. Set channel levels. Press [At] [Clear] to delete the selected channels.	If the channels are new, this adds them to the part at the level indicated. If already in the part, this modifies their level
7. Press [S7], <b>More Softkeys</b> , until <b>Part</b> appears as softkey [S1].	Finds the Part softkey again
8. Press [Record] [S1], <b>Part</b> , [2] [Enter].	Records the changes into part 2 of the cue

## ***Using Update***

With Update, you can do live editing of cue parts in Stage and see the results immediately on stage. Use the procedure below to add channels and set levels, assuming you previously created multipart cue 1.

<b>Keystrokes:</b>	<b>Action:</b>
1. Press [Stage]	Selects stage display
2. Press [S8], <b>Fixture</b> , [4]	Selects fixture 4
3. Set intensity, pan and tilt levels.	
4. Press [S2], <b>Update</b> .	Prompt reads: <b>To update cue, select number and press ENTER (TRACK + ENTER for tracking)</b> <b>To cancel, press CLEAR</b>
5. Press [Cue] [1].	Selects multipart cue 1 to update
6. Press [S7], <b>More Softkeys</b> , until <b>Part</b> appears as softkey [S1].	Finds the Part softkey
7. Press [S1], <b>Part</b> , [2] [Enter].	Updates part 2 of cue 1



## Modifying fade and wait times

If you do not assign fade and wait times to a part, the console assigns default times.<sup>23</sup> No wait time will be recorded. Follow these steps to assign fade and wait times to parts to a multipart cue:

### Keystrokes:

1. Press [Blind].
2. Enter the cue number.
3. Press [S7], **More Softkeys**, until **Part** appears as softkey [S1].
4. Press [S1], **Part**, then press [+] or [-] until the part you want to edit is displayed.
5. Press [Time].
6. Enter an upfade time between .1 second and 99:59 minutes and press [Enter].
7. If you want a downfade time that is different from the upfade, enter the desired time and press [Enter]. If not, just press [Enter].
8. Press [Wait].
9. Enter wait time and press [Enter]. Wait time is the delay between when you press [Go] and when the part begins. If you do not enter a wait time, the console assigns a wait time of zero.

### Action:

- Selects Blind display mode
- Prompt reads:  
**Select cue number**  
**To select cue type, press TYPE**
- Finds the Part softkey
- Prompt reads:  
**Select part number**
- Prompt reads:  
**Enter upfade time**
- Prompt reads:  
**Enter downfade time**
- Fade times are set for the part
- Prompt reads: **Enter wait time**
- Wait time is set for the part

---

<sup>23</sup>. See [Setting default fade times, page 24](#).



# ***Chapter 10***

## ***Playing back cues***

The console has two timed faders that allow you to play back recorded cues. Cue selection and playback can be automated, or you can control them manually.

This chapter includes the following sections:

- Selecting cues
- Timed faders
- Playback Cue List
- Fader Status display
- Selecting and playing cues
- Go to a different cue
- Controlling fades manually
- Quickstep

## Timed faders

The console has two timed fader pairs, called the A/B and C/D fader pairs, that allow you to play back recorded cues (A/B pair illustrated at right). The left slider (A and C) of each fader pair controls upfades. The right slider (B and D) of each fader pair controls downfades. When reference is made in this and other sections of this User Manual to a fader, you should assume that both sliders of the fader pair are implied unless otherwise noted.

You may play back a cue using the timing information programmed into it, or you may take manual control of the slider(s). Taking manual control of faders is covered under [Controlling faders manually, page 125](#).

You may play back cues one at a time through the same fader, or you may simultaneously play back a different cue in each fader. For example, you may play a ten-minute sunset cyc cue in one fader and play several cues during the same period in the other fader. You may also play a cue in one fader, leave it there, and then play another cue in the second fader.

The faders function in level override mode. This means that the fader sliders control the percentage of completion of the fade.

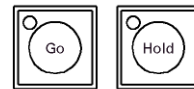
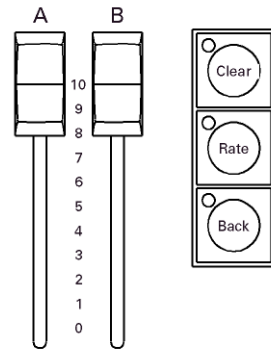

# Fader keys

## Clear

Each fader is equipped with a Clear key. To remove a cue from the fader, press the appropriate Clear key. Clear an effect cue by pressing either once or twice. If the effect cue is in an upfade or dwell time, pressing [Clear] once starts a downfade and pressing [Clear] again ends the downfade in the fader clear time. Pressing [Clear] while an effect is in a downfade ends the downfade in the fader clear time.<sup>24</sup>

## Go

Each fader has its own Go key. If you press [Go] before a cue finishes playing, the previous cue stops, and the new cue begins from the levels at which the previous cue was interrupted. Press [Go] to play back the cue selected on the Cue List. Press [Go] to resume a fade that has been interrupted by pressing [Hold].

## Hold

Each fader has its own Hold key. If a cue is running, press [Hold] to pause playback of the cue. Press [Hold] a second time to cancel playback of the cue in the fader, leaving it in the fader where it stopped, or press [Go] to resume the fade.

## Back

Each fader has its own Back key. Press [Back] to replay the cue most recently played on that fader. Press [Back] again to play the cue before it on the Cue List, and so forth, moving backward through the Cue List. Cues play back using the fade and wait times recorded with the cue.

The cue following the cue replayed by pressing [Back] becomes the first cue in the Cue List. If you then press [Go], that cue plays. Replaying with Back ignores cue links.

This example demonstrates the use of the Go, Hold and Back keys:

<b>Keystrokes:</b>	<b>Action:</b>
1. Press [Stage].	Selects Stage mode display
2. Press [Cue] [2].	Selects cue 2
3. Press [Go].	Runs cue 2
4. While cue is running, press [Hold].	Running cue pauses
5. Press [Go].	Cue resumes
6. Once cue finishes, press [Back].	Previous cue fades up on stage

---

<sup>24</sup> The default fader clear time is zero, which means that pressing [Clear] ends a downfade immediately. For instructions on changing fader clear time, see [Setting default fader clear time, page 25](#).

## Cue List

The Cue List in the Stage and Blind displays, shown below, is a short list of cues in the show. Shown along with cues are cue attributes, such as fade timing, linking and the cue's label, if any.

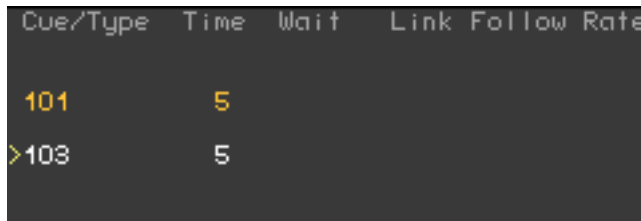

Cue/Type	Time	Wait	Link	Follow	Rate
101	5				
>103	5				

### Cue indicators

The color in which a cue is displayed provides information about the cue's current status.

**Gray**..... Cue is not selected and is not in a fader.

**White**..... Pending cue, will play back next time either Go key is pressed.

**Yellow** ..... Cue is in a fader, and is selected in Stage.

**Gold**..... Cue is in a fader, but is not selected in Stage.

**Light red** ..... Cue is currently running and is selected in Stage.

**Dark red** ..... Cue is currently running, but is not selected in Stage.

**>** ..... Cue is selected in Stage or Blind.

## Fader Status display

The fader status display consists of two windows located near the bottom of the Stage and Blind displays. These are illustrated below.

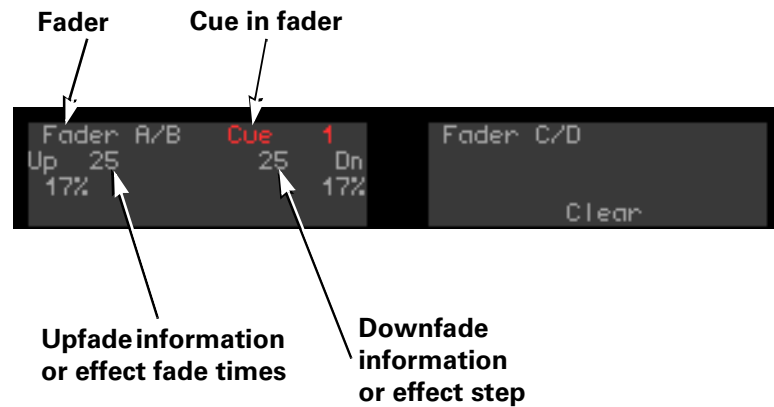

The fader status display provides information about the cues loaded to the console's faders, including fade times and rates. The left window monitors the A/B fader; the right window monitors the C/D fader. The display counts down wait times for cues and indicates which step is running when an effect is active.

## Selecting cues

There are many ways that you can determine which cue will play next on stage, including the following.

- You can select a cue from the keypad and press [Go].
- Press [Go] without selecting a cue. The console will play either the next cue in the Cue List or the cue linked to the cue that played last. See [Link, page 88](#).
- Run a macro that contains a command to play a particular cue.
- Run a subroutine that contains a list of cues to be played automatically.
- Program a cue with Follow (see [Follow, page 89](#)). After you run the cue that has been set with a Follow command, the next cue in sequence (or a linked cue) runs automatically.
- Press [Go] while a loop constructed with Link and Follow commands is running. A non-loop cue will be played in accordance with rules explained in [Create playback loops with Link and Follow, page 90](#).

You must be in either the Stage or the Fader displays to select cues to play back, but you can run a selected cue from Blind as well as Stage or Fader. You see the cue running on the monitor in the Stage and Fader displays.

## ***Playing a cue***

Selecting a cue moves it to the top of the Cue List. It will not run until you press [Go]. Follow these steps to select a cue and play it on the fader of your choice.

### **Keystrokes:**

1. Press [Stage].
2. Press [Cue].
3. Press [1][.][5].
4. Press [Go] on fader A/B.
5. Press [Go] on fader C/D.

### **Action:**

Selects Stage display mode  
Prompt reads:  
**Select cue number**  
**To select cue type, press TYPE**  
Selects cue 1.5 to play. Cue List moves cue 1.5 to the top of the list  
Cue 1.5 runs on fader A/B; Cue 2 moves to the top of the Cue List  
Cue 2 starts to run on fader C/D

## ***Go to a different cue***

To play back a cue other than the cue highlighted on the Cue List, follow these steps:

### **Keystrokes:**

1. Press [Stage].
2. Press [Cue] [2].
3. Press [Go].

### **Action:**

Selects Stage mode display  
Selects cue 2  
Runs cue 2



## ***Controlling fades manually***

The console provides two ways to take manual control of cue playback; manual override and rate override.

### ***Manual override***

Manual override allows you to use the fader sliders to take manual control of fade levels. When you take manual control of cue playback, moving the fader slider controls the fade.

Leave the fader sliders at **10** before pressing [Go] to play cues back as recorded.

When you move the fader sliders below **10**, the cue runs until it reaches the slider setting. You can set the slider before you play the cue, or move the slider after the fade starts. The fade stops when it reaches the slider's level, and the slider then controls the fade. For example, if you set the sliders at **8**, the cue will play until it reaches 80 percent of its recorded levels, then give you manual control.

Set the sliders at **0** before you press [Go] to take manual control of fade from the beginning of cue.

*Hint: If you start a cue, and the performers skip ahead to the next cue, you have two options for speeding up to the next cue. If you do not need the current cue to reach its full intensity level settings, press [Go] to interrupt the current cue and begin the next one. However, if you need the current cue to reach its full level settings, push the sliders down and then back up to **10** immediately. Then press [Go] to start the next cue.*

Once the fade is complete, the cue is no longer controlled by the fader.

## **Rate override**

Rate override allows you to control both the fade's rate and percentage of completion. When you play back a cue using rate override, the console controls the percentage of completion, but you control the rate.<sup>25</sup>

Rate override allows you to play back a cue faster or slower than the rate at which it was recorded. The trackpad adjusts the fade rate.

Fade rate is expressed as a percentage. A cue with a fade rate of 100 percent plays back at its recorded fade time. A fade rate of 300 plays the cue back three times faster than its recorded fade time. A fade rate of 50 plays the cue back half as fast as its recorded fade time. For example, if you record a cue with a 10 second fade time, a rate of 200 causes it to play back in five seconds. A fade rate of 50 causes it to play back in 20 seconds.

You may take control of a cue's fade rate while the cue is running. In addition, you may press both [Rate] keys to control rate of both fades.

Follow this example to place a cue in a fader under rate override:

<b>Keystrokes:</b>	<b>Action:</b>
1. Press [Rate] key for the fader in which the cue is running. (Press both [Rate] keys if you wish to control both faders.)	Activates rate control
2. Move your finger over the trackpad.	Fades are placed under control of the trackpad. Fader Status window shows the current rate

---

<sup>25</sup> When finished with the manual rate override, you can record the modified fade rate into the cue if you wish. See [Using Update to modify fade rate, page 98](#).

## Quickstep

Quickstep allows you to run through a show, checking all cues, without having to wait for fades. When Quickstep is active, the faders ignore all upfade, downfade, follow, and wait times. Cues snap immediately to their completed levels when you press [Go] or [Back].

To enable Quickstep and run a cue check, follow these steps:

<b>Keystrokes:</b>	<b>Action:</b>
1. Press [Stage].	Selects Stage display
2. Press [S7], <b>More Softkeys</b> , [S1], <b>Enable Quickstep</b> .	Turns on Quickstep
3. Press [Cue] [1].	Selects cue 1
4. Press [Go].	Cue 1 comes up on stage instantly
5. Continue to press [Go] until you have checked all cues.	Each cue comes up on stage instantly
6. Once you are finished, press [S1], <b>Disable Quickstep</b> .	Turns off Quickstep; fades will operate normally



# *Chapter 11*

## *Groups*

The console allows you to record frequently used combinations of channels into units called groups. You may record up to 500 groups.

Once you record a group, it can be combined with other channels and groups to create cues, submasters, effects, focus points or other groups. The principal difference between a group and a cue is that a group cannot be played back through a fader or slider. Consequently, it has no fade times, wait times or other playback attributes.

Group numbers, which are independent of cue numbers, are whole numbers in the range of 1 to 999.

This chapter includes the following sections:

- Creating groups
- Working with groups in Blind
- Working with groups in Stage
- Modifying groups
- Labeling groups
- Deleting groups
- Copying groups
- Using cues or submasters as groups
- Using groups to modify cues, groups or submasters

## ***Recording a group in Stage***

The following example illustrates the creation of a group using newly selected channels.

<b>Keystrokes:</b>	<b>Action:</b>
1. Press [Stage].	Selects the Stage display
2. Press [1] [Thru] [5] [Full] [And] [8] [And] [1][0] [At] [5] [Enter].	Select channels and set levels
3. Press [Record] [Group].	Prompt reads: <b>To record group, select number and press ENTER</b>
4. Press [1].	Selects group 1 to record
5. Press [Enter].	Records group 1

## ***Recording a group from a look on stage***

To create a group from the look that's already on stage, follow these steps.

<b>Keystrokes:</b>	<b>Action:</b>
1. Press [Stage].	Selects Stage display mode
2. Press [Record] [Group].	Prompt reads: <b>To record group, select number and press ENTER</b> <b>To cancel, press CLEAR</b>
3. Press [2].	Enters the group number you want to record Corner reads: <b>Group 2</b>
4. Press [Enter].	Records group 2

## ***Recording a group using Solo***

You can use Solo to selectively record into a group in the same manner as using Solo to selectively record into a cue. There are two ways to select channels with Solo: while clearing other independent channels such as other lights and while clearing ALL other channels, including non-independent ones. See [Recording a cue using Solo, page 92](#), for the procedures to use, substituting the [Group] key where those procedures specify the [Cue] key.

## ***Working with groups in Blind***

There are two modes of operation in Blind for changing groups—Group mode and Group Editing mode. In Group mode, the console brings up the channels from a group of your choice and allows you to use them to modify cues, submasters and other groups. In Group Editing mode, the console allows you to create or edit the group itself.

### ***Group mode***

You enter Group mode in Blind by specifying a level after identifying the group. The level is applied proportionally to all channels in the group. Follow the procedure below to work in Group mode.

<b>Keystrokes:</b>	<b>Action:</b>
1. Press [Blind].	Selects Blind display mode
2. Press [Group] [1].	Selects group 1's channels Prompt reads: <b>Group mode – To recall a group, select the number and set it to a level</b>
3. Press [At] [7][5].	<b>To create or modify a group, select the number and press ENTER</b> Sets the channels to 75 percent of their recorded levels Prompt reads: <b>Group mode – Press AT or use wheel or trackpad to alter levels, or select channel numbers to edit</b>
4. Press [Record] [Cue] [3] [Enter].	Records the current level settings as cue 3

## ***Group Editing mode in Blind***

Add or delete channels or change channel levels in a recorded group by first entering Group Editing mode in Blind. You can also set group levels with reference to a focus point.<sup>26</sup>

<b>Keystrokes:</b>	<b>Action:</b>
1. Press [Blind].	Selects Blind display mode
2. Press [Group] [1].	Selects group 1's channels Prompt reads: <b>Group mode – To recall a group, select the number and set it to a level To create or modify a group, select the number and press ENTER</b>
3. Press [Enter].	Sets channels to their levels recorded in the group Prompt reads: <b>Select channel numbers</b>
4. Press [2][5] [Thru] [3][0] [At] [5][0].	Modifies look, adding channels 25 through 30 at 50 percent
5. Press [Record].	Prompt reads: <b>To record group, select number and press ENTER To cancel, press CLEAR</b>
6. Press [Enter]. <sup>a</sup>	Records the modified group

a. *Specify a number here to record to a different group, such as [5][0] [Enter]. If that group exists, it is overwritten. If it does not exist, it is created.*

---

<sup>26</sup>. See [Setting levels with focus points, page 150](#).



# Working with groups in Stage

## Displaying a group

To view a recorded group on stage, follow these steps:

Keystrokes:	Action:
1. Press [Stage].	Selects Stage display mode
2. Press [Group] [2].	Selects group 2 Prompt reads: <b>Group mode – Select group number to use as group</b>
3. Press [Full].	Prompt reads: <b>Group mode – Press AT or use wheel or trackpad to alter levels, or select channel numbers to edit</b>

## Modifying a group

Follow the procedure below to modify a recorded group in Stage and then record the modifications into the same group or into a different group.

Keystrokes:	Action:
1. Display the group on stage as illustrated above.	
2. Select channels you want to modify and adjust channel levels.	Alters look
3. Press [Record] [Group].	Prompt reads: <b>To record group, select number and press ENTER</b> <b>To cancel, press CLEAR</b>
4. Press [Enter]. <sup>a</sup>	Records modifications into the group

*a. Record the modifications into a different group by pressing the other group's number before you press [Enter] in this step.*

## Updating groups

Update allows you to modify previously recorded cues, groups, submasters or focus points in Stage. Update takes levels from all captured and selected channels, and those selected may be restricted with the Only command.<sup>27</sup>

### Updating an active group

The following procedure illustrates how to update a group that has been placed on stage.

Keystrokes:	Action:
1. Press [Stage].	Selects Stage display mode
2. Press [Group] [4] [Full].	Places group 4 on stage at full
3. Modify channel levels as desired.	Sets group levels or selects additional channels and sets their levels
4. Press [S2], <b>Update</b> .	Prompt reads: <b>To update cue, select number and press ENTER</b> <b>To cancel, press CLEAR</b>
5. To restrict channels in the update, use Only here. <sup>a</sup>	Restricts channels in update Prompt reads: <b>Select channel number(s) -</b> <b>To cancel, press CLEAR</b> <b>(Press 0 to reselect all non-zero channels)</b>
6. Press [Group] [4] [Enter].	Updates group 4

*a. If not restricted with Only, all captured and selected channels are included in the update.*

---

<sup>27.</sup> For an explanation of captured channels, see [Channel modes, page 52](#). For an explanation of Only, see [The Only command, page 8](#).

## ***Updating a recorded group***

You need not place a group on stage to update it. The following procedure illustrates how to update any recorded group.

<b>Keystrokes:</b>	<b>Action:</b>
1. Press [Stage].	Selects Stage display mode
2. Press [5][0] [Thru] [7][5] [At] [9] [Enter].	Selects channels and sets levels
3. Press [S2], <b>Update</b> , [Group] [3].	Selects group 3 to update Prompt reads: <b>To update group, select number and press ENTER</b> <b>To cancel, press CLEAR</b>
4. To restrict channels in the update, use Only here. <sup>a</sup>	Selects channels to update Prompt reads: <b>Select channel numbers -</b> <b>To cancel, press CLEAR</b> <b>(Press 0 to reselect all non-zero channels)</b>
5. Press [Enter].	Updates group 3

*a. If not restricted with Only, all captured and selected channels are included in the update.*

## Labeling groups

If you have Expression Off-Line, you may assign labels to your groups.<sup>28</sup> Group labels can consist of any combination of letters, numbers and symbols, and may be up to 16 characters long.

Follow these steps to label a group:

<b>Keystrokes:</b>	<b>Action:</b>
1. Press [Blind].	Selects Blind display mode
2. Press [Group] [1].	Prompt reads: <b>Group mode – To recall a group, select the number and set it to a level</b> <b>To create or modify a group, select the number and press ENTER</b>
3. Press [Enter].	Prompt reads: <b>Select channel numbers</b>
4. Press [Label]. <sup>a</sup>	Prompt reads: <b>Type group label</b> <b>(F6 = clear to end,</b> <b>F7 = last group label,</b> <b>F8 = next group label)</b>
5. Use the alphanumeric keyboard to enter a label.	Corner displays your label
6. Press [Enter].	Group 1 is labeled

*a. Not available on the Express console. You may type keyboard equivalent "B" in Expression Off-Line as a substitute for the Label key.*

---

<sup>28.</sup> For information about Expression Off-Line and how to order it, see [Expression Off-Line, page 306](#).

## Deleting groups

Delete a group from memory in the Stage, Blind or Fader displays.<sup>29</sup> Deleting a group has no effect on any cues, groups, submasters or focus points into which the deleted group was previously recorded.

Delete a group in Stage as follows:

<b>Keystrokes:</b>	<b>Actions:</b>
1. Press [Stage].	Selects Stage display
2. Press [S7], <b>More Softkeys</b> , [S6], <b>Delete</b> , [Group].	Prompt reads: <b>To delete group, press ENTER</b> <b>To cancel, press CLEAR</b>
3. Press [2].	Enters group number to delete Corner reads: <b>Group 2</b>
4. Press [Enter] [Enter].	Group 2 is deleted from your show

## Copying groups

You may copy a group in Stage or Blind, with small differences in the procedure and prompts that occur. The following procedure illustrates how to copy a group in Stage.

<b>Keystrokes:</b>	<b>Actions:</b>
1. Press [Stage].	Selects Stage display
2. Press [Group].	Prompt reads: <b>Group mode – Select group number to use as group</b>
3. Press [1].	Enters the number of the group you wish to copy Corner reads: <b>Group 1</b>
4. Press [Full].	Prompt reads: <b>Group mode – Press AT or use wheel or trackpad to alter levels, or select channel numbers to edit</b>
5. Once the group is displayed, press [Record] [Group]. <sup>a</sup>	Prompt reads: <b>To record group, select number and press ENTER</b> <b>To cancel, press CLEAR</b>
6. Press [5] [Enter].	Enters the number of the new group and completes the Copy. Corner reads: <b>Group 5</b>

*a. To copy a group's channels and levels to a cue or a submaster, press [Cue] or [Sub] in place of [Group] in step 5.*

---

<sup>29.</sup> You can delete all groups at once with the Clear Groups option from the Clear Functions menu. See [Clear and reset options, page 255](#).

## Using cues and submasters as groups

You may treat channels recorded in a cue or submaster as if they were in a group, such as to bring them up in Stage or record them into other cues or submasters.<sup>30</sup>

For example, follow this procedure to bring up a cue in Stage as a group:

<b>Keystrokes:</b>	<b>Actions:</b>
1. Press [Stage].	Selects Stage display mode
2. Press [Group].	Tells the console to treat the next entry as a group Prompt reads: <b>Group mode – Select group number to use as group</b>
3. Press [Cue] and enter the number of the cue you want to bring up. <sup>a</sup>	Prompt reads: <b>Group mode – Select cue number to use as group</b>
4. Press [At] and enter the level at which you wish to bring up the cue. (Or press [Full])	The cue's channels are brought up on stage at the specified level Prompt reads: <b>Group mode – Enter intensity</b>

- a. *To use a submaster as a group, follow the same procedure, but press [Sub] instead of [Cue] in step 3.*

---

<sup>30</sup>. *You may not use this procedure to group the channels in a cue part, an effect cue or an effect submaster.*

## ***Modifying cues or submasters***

You can use groups to modify cues or submasters. In the illustration below, a submaster is modified by a group. If any of this group's channels are already in the submaster, the levels of those channels are modified to match the levels in the group. If the group has channels not already in the submaster, those are added to the submaster.

<b>Keystrokes:</b>	<b>Action:</b>
1. Press [Blind].	Selects Blind display mode
2. Press [Sub] [2].	Prompt reads: <b>Select submaster number</b> <b>To select submaster type, press</b> <b>TYPE</b>
3. Press [Group] [3].	Selects group 3's channels Prompt reads: <b>Group mode –</b> <b>To recall a group, select the number</b> <b>and set to a level</b> <b>To create or modify a group, select</b> <b>the number and press ENTER</b>
4. Press [At] [5][0].	Group's channels are set proportionally to 50% Prompt reads: <b>Group mode – Enter intensity</b>
5. Press [Record].	Prompt reads: <b>To record submaster, press BUMP</b> <b>or select number and press ENTER</b> <b>To cancel, press clear</b>
6. Press [Enter] to re-record the modified submaster.	Records submaster 2 as modified by group 3's channels





# *Chapter 12*

## *Focus points*

When working with moving lights, sometimes the attributes of several lights are stored together in a group and the group recorded into one or more cues. If the group changes, such as if the lights are repositioned toward another point on stage, the cues need to be manually updated or replaced to account for that change.

Focus points can be used to provide automatic updating in situations like this and others, such as when colors are changed after show programming is essentially complete. Channels referencing focus points that store color information automatically update when the color channels in the focus point change. If many references are made to these focus points in the show, all will change when the focus point changes, making widespread updating a convenient operation.

The console allows up to 99 user-definable focus points.

The topics covered in this chapter include:

- Creating focus points
- Displaying focus points on Stage
- Working with focus points in Stage
- Editing focus points in Blind
- Labeling focus points
- Deleting focus points
- Copying focus points
- Setting levels with focus points

## ***Recording a focus point***

You can create a focus point in Stage, Blind or Fader displays using all the same techniques available to create groups.

### ***Recording a focus point in Stage***

The following example illustrates the creation of a focus point containing settings for the intensity and position attributes of several fixtures. Note the use of Only to conveniently identify the position category.

<b>Keystrokes:</b>	<b>Action:</b>
1. Press [Stage].	Selects the Stage display
2. Press [S8], <b>Fixture</b> , [1].	Selects fixture 1
3. Set intensity, pan and tilt levels.	
4. Press [+], [-] or [S8] to select another fixture.	
5. Repeat steps 3-4.	Repeat procedure for all fixtures to be included in the focus point
6. Press [Record] [Focus Point].	
7. Press [3].	Enters number of focus point
8. Press [Enter].	Records focus point 3

### ***Creating a focus point from a look on stage***

To create a focus point from the look that is already on stage, follow these steps:

<b>Keystrokes:</b>	<b>Action:</b>
1. Press [Stage].	Selects Stage display mode
2. Press [Record] [Focus Point].	Prompt reads: <b>To record focus point, select number and press ENTER</b> <b>To cancel, press CLEAR</b>
3. Press [2].	Enters the focus point number you want to record Corner reads: <b>Focus 2</b>
4. Press [Enter].	Records focus point 2

## ***Recording a focus point using Solo***

You can use Solo to selectively record into a focus point in the same manner as using Solo to selectively record into a cue or group. There are two ways to select channels with Solo: while clearing other independent channels such as other lights and while clearing ALL other channels, including non-independent ones. See [Recording a cue using Solo, page 92](#), for examples of these two procedures. When using those procedures to record channels into a focus point rather than into a cue, press the [Focus Point] key where they call for pressing the [Cue] key.

When working with focus points, you are more likely to record selected attribute settings for moving lights than the intensities of ordinary fixtures. For example, you might use a focus point to store the pan and tilt settings for several lights aimed at a particular location on stage. Or, you might want to store the settings of colors for those moving lights so that you can use them later when recording cues, groups or submasters.

Remembering that all attributes but the intensity of moving lights are independent, only the Solo procedure that can clear either of these allows you to select out moving light attributes such as position and color. This was procedure was explained under [Using Solo as a pre-recording filter, page 92](#). An example of its use for moving lights is given below.

### **Keystrokes:**

1. Press [Blind].
2. Press [S8], Fixture, [1][0] [Thru] [1][5].
3. Press [Only] [Color].
4. Press [Record] [Focus Point] [7] [Solo].

### **Action:**

- Selects the Blind display mode
- Selects moving light fixtures 10 through 15
- Restricts the selection to the color attributes of these fixtures
- Records the color attribute settings into cue 7

# Working with focus points in Stage

## Placing a focus point on stage

You can place an entire focus point on stage with or without the focus point references, then record those channels into something else. If the references are present, you know the channels will automatically update where they were recorded if their levels change in the focus point.

Follow the procedure below to place a focus point on stage with the references. Note the footnote showing how to place the focus point channels on stage without the references.

<b>Keystrokes:</b>	<b>Action:</b>
1. Press [Stage].	Selects Stage display mode
2. Press [Focus Point] [2] [Focus Point] [2]. <sup>a</sup>	Selects the channels of focus point 2 and links them to the focus point itself Prompt reads: <b>Select focus point and press ENTER</b>
3. Press [Enter].	Prompt reads: <b>Group mode – Press AT or use wheel or trackpad to alter levels, or select channel numbers to edit</b>

- a. To drop the reference (and also the updating capability), you need only select the focus point channels and set a proportional level, such as press [Focus Point] [2] [Full] (no need to press [Enter] in step 3).*

## Modifying a focus point

Follow the procedure below to modify a recorded focus point in Stage:

<b>Keystrokes:</b>	<b>Action:</b>
1. Display focus point 2 in Stage as illustrated above.	
2. Press [S8], <b>Fixture</b> , [3] [Thru] [8] [Full].	Sets the intensity of fixtures 3 through 8 to full
3. Press [Record] [Focus Point] [2]. <sup>a</sup>	Prompt reads: <b>To record focus point, select number and press ENTER</b> <b>To cancel, press CLEAR</b>
4. Press [Enter].	Records modifications into focus point 2

- a. You can record to the same or to a different focus point.*

## Updating focus points

Update allows you to modify previously recorded cues, groups, submasters or focus points in Stage. Update takes levels from all captured and selected channels, and those selected may be restricted with the Only command.<sup>31</sup>

### Updating an active focus point

The following procedure illustrates how to update a focus point that has been placed on stage.

Keystrokes:	Action:
1. Press [Stage].	Selects Stage display mode
2. Press [Focus Point] [4] [Full].	Places focus point 4 on stage at full
3. Modify channel levels as desired.	Sets focus point levels or selects additional channels and sets their levels
4. Press [S2], <b>Update</b> .	Prompt reads: <b>To update cue, select number and press ENTER</b> <b>To cancel, press CLEAR</b>
5. To restrict channels in the update, use Only here. <sup>a</sup>	Restricts channels in update Prompt reads: <b>Select channel number(s) -</b> <b>To cancel, press CLEAR</b> <b>(Press 0 to reselect all non-zero channels)</b>
6. Press [Focus Point] [4] [Enter].	Updates focus point 4

*a. If not restricted with Only, all captured and selected channels are included in the update.*

---

<sup>31.</sup> For an explanation of captured channels, see [Channel modes, page 52](#). For an explanation of Only, see [The Only command, page 8](#).

## ***Updating a recorded focus point***

You need not place a focus point on stage to update it. The following procedure illustrates how to update any recorded focus point.

<b>Keystrokes:</b>	<b>Action:</b>
1. Press [Stage].	Selects Stage display mode
2. Press [S8], <b>Fixture</b> , [8], [Full].	Sets fixture 8 intensity to full
3. Press [Only] [Color] [At] [5][0].	Sets levels for fixture 8 color category at 50%
4. Press [S7], <b>More Softkeys</b> .	Returns to main Stage softkeys
5. Press [S2], <b>Update</b> , [Focus Point] [3].	Selects focus point 3 to update Prompt reads: <b>To update focus point, select number and press ENTER</b> <b>To cancel, press CLEAR</b>
6. To restrict channels in the update, use Only here. <sup>a</sup>	Selects channels to update Prompt reads: <b>Select channel number(s) -</b> <b>To cancel, press CLEAR</b> <b>(Press 0 to reselect all non-zero channels)</b>
7. Press [Enter].	Updates focus point 3

*a. If not restricted with Only, all captured and selected channels are included in the update.*

## ***Editing a focus point in Blind***

You may modify a focus point in Blind. For example, add or delete fixtures or set levels of fixture attributes.

Follow the procedure below to set fixture attribute levels in a focus point. The selected fixtures need not already be represented in the focus point.

<b>Keystrokes:</b>	<b>Action:</b>
1. Press [Blind].	Selects Blind display mode
2. Press [Focus Point] [1].	Selects focus point 1's channels Prompt reads: <b>Group mode – To recall a focus point, select the number and set it to a level</b> <b>To create or modify a focus point, select the number and press ENTER</b>
3. Press [Enter].	Displays non-zero levels of all focus point channels Prompt reads: <b>Select channel numbers</b>
4. Press [S8], Fixture, [8] [Thru] [1][2] [Only] [Color] [At] [5][0].	Sets the color attribute(s) of fixtures 8 through 12 to 50
5. Press [Record] [Enter]. <sup>a</sup>	Re-records focus point 1 as modified

*a. Specify a number here to record to a different focus point, such as [Record] [5][0] [Enter]. If that focus point exists, it is overwritten. If it does not exist, it is created.*

## Labeling focus points

If you have Expression Off-Line, you may assign labels to your focus points.<sup>32</sup> Focus point labels can consist of any combination of letters, numbers and symbols and may be up to 16 characters long.

Follow these steps to label a focus point:

<b>Keystrokes:</b>	<b>Action:</b>
1. Press [Blind].	Selects Blind display mode
2. Press [Focus Point] [1].	Prompt reads: <b>Group mode – To recall a focus point, select the number and set it to a level</b> <b>To create or modify a focus point, select the number and press ENTER</b>
3. Press [Enter].	Prompt reads: <b>Select channel numbers</b>
4. Press [Label]. <sup>a</sup>	Prompt reads: <b>Type focus point label</b> <b>(F6 = clear to end,</b> <b>F7 = previous focus point label,</b> <b>F8 = next focus point label)</b>
5. Use the alphanumeric keyboard to enter a label.	Corner displays your label
6. Press [Enter].	Focus point 1 is labeled

*a. Not available on the Express console. You may type keyboard equivalent "B" in Expression Off-Line as a substitute for the Label key.*

---

<sup>32.</sup> For information about Expression Off-Line and how to order it, see [Expression Off-Line, page 306](#).



## Deleting focus points

Delete a focus point from memory in the Stage, Blind or Fader displays.<sup>33</sup> If any cues, groups or submasters are linked to the deleted focus point, the links are retained but the levels of the linked channels are set to zero.

Delete a focus point in Stage as follows:

<b>Keystrokes:</b>	<b>Actions:</b>
1. Press [Stage].	Selects Stage display
2. Press [S7], <b>More Softkeys</b> , [S6], <b>Delete</b> , [Focus Point].	Prompt reads: <b>To delete focus point, press ENTER</b> <b>To cancel, press CLEAR</b>
3. Press [2].	Enters focus point number to delete Corner reads: <b>Focus 2</b>
4. Press [Enter] [Enter].	Focus point 2 is deleted from your show

## Copying focus points

You may copy a focus point in Stage or Blind with small differences in the procedure and prompts. Proceed as follows in Stage:

<b>Keystrokes:</b>	<b>Actions:</b>
1. Press [Stage].	Selects Stage display
2. Press [Focus Point].	Prompt reads: <b>Group mode – Select focus point to use as group</b>
3. Press [1].	Selects focus point 1 to copy Corner reads: <b>Focus 1</b>
4. Press [Full].	Prompt reads: <b>Group mode – Press AT or use wheel or trackpad to alter levels, or select channel numbers to edit</b>
5. Once the focus point is displayed, press [Record] [Focus Point]. <sup>a</sup>	Prompt reads: <b>To record focus point, select number and press ENTER</b> <b>To cancel, press CLEAR</b>
6. Press [5] [Enter].	Enters the number of the new focus point and completes the Copy. Corner reads: <b>Focus 5</b>

a. To copy a focus point's channels and levels to a cue or a submaster, press [Cue] or [Sub] in place of [Focus Point] in step 5.

---

<sup>33</sup>. You can delete all focus points at once with the Clear Focus Points option from the Clear Functions menu. See [Clear and reset options, page 255](#).

## Setting levels with focus points

Focus points are commonly used as level setting devices for fixtures, but they can be used to set levels for individual channels as well. First, create a focus point with a certain characteristic, such as all fixtures pointed to a particular location or set to a certain color. Then, set individual fixtures at the levels contained in the focus point as part of your recorded cues, groups or submasters. Since those recordings are linked to the focus point, if levels in the focus point change, the corresponding levels in the recordings change to match those in the focus point. For example, if you change the position levels in the focus point, any cues, groups or submasters recorded with reference to those fixture positions in the focus point change at the same time.

Sometimes, however, you may want to use a focus point to set channel or attribute levels without preserving the link to the focus point. You can do that with a unique application of the [Level] key.

The following procedure illustrates how to use a focus point in Blind to set the position attributes of fixtures, link the levels to the focus point and record the result into a cue. The footnote to the procedure explains how to accomplish the same purposes but without the link.

1. Press [Blind].                      Selects the Blind display
2. Press [S8], **Fixture**, [1]        Selects fixtures 1 and 2  
   [And] [2].
3. Press [Only] [Position]        Sets the pan and tilt attributes of  
   [Focus Point] [6] [Enter]<sup>a</sup>.       fixtures 1 and 2 at focus point 6
4. Press [Record] [1][0].        Records into cue 10
  - a. For level setting without a link, substitute [Level] for [Enter] in this step.

# *Chapter 13*

## *Submasters*

Express provides you with 24 submaster sliders. A submaster is a group of channels recorded at proportional levels and controlled by a slider and a bump button. Submasters enable you to save complex looks you use frequently and play them back manually. They can also be used as building blocks when you create scenes, cues or other submasters.

A channel may be included in any number of submasters. You can record a total of 240 submasters (24 submasters in each of ten pages of submaster memory).

Each submaster slider is accompanied by a bump button and one LED. The slider allows you to bring up the submaster look manually. The bump button allows you to flash the submaster to its full recorded level or to begin its programmed fade, if it has one. The LEDs show you which sliders control recorded submasters.

This chapter includes the following sections:

- Submaster types
- Submaster pages
- Playback Submaster List
- Submaster LEDs
- Submaster bump buttons
- Recording submasters
- Creating inhibitive submasters
- Modifying submasters in Blind
- Modifying submasters in Stage
- Using Update to modify submasters
- Live control of a submaster
- Controlling submaster fades manually
- Labeling submasters
- Copying submasters
- Loading cues or groups to submasters
- Copying cues or groups to submasters
- Clearing submasters

## **Submaster types**

Submasters can be pile-on, inhibitive or effect.

### ***Pile-on submaster***

A pile-on submaster consists of channels recorded at proportional levels. If a pile-on submaster's channel levels are higher than established channel levels, the submaster's levels take precedence (except as noted below). If they are lower, the established levels take precedence. If a submaster slider contains a recorded pile-on submaster, the LED glows.

*Note: Channel levels set on the keypad and inhibitive submasters both override pile-on submaster levels.*

### ***Inhibitive submaster***

An inhibitive submaster holds the output of channels below a specified level. An inhibitive submaster doesn't actually set channel levels, it just prevents them from exceeding a specified level. All Express submasters may be inhibitive. If a submaster slider contains a recorded inhibitive submaster, the LED glows.

### ***Effect submaster***

An effect submaster has an effect recorded in it. Press an effect submaster's bump button or move its slider to start the effect running. See [Chapter 16 Effects, page 197](#) for more information on effect submasters. Any submaster may be programmed with an effect. If a submaster slider contains a recorded effect submaster, the LED glows.

## Changing type

You can change a submaster's type by using the [Type] key. When you change a submaster type, levels recorded in the submaster are retained. This means that you can change a submaster from pile-on to inhibitive and back without losing any level or timing information. If you change the type to effect, channel and level information is erased.

To change a submaster's type, follow these steps:

<b>Keystrokes:</b>	<b>Action:</b>
1. Press [Blind].	Selects Blind display
2. Press [Sub] [#].	Prompt reads: <b>Select submaster number</b>
3. Press [Type].	Prompt reads: <b>Select submaster type</b> <b>(1 = Pile-on, 2 = Inhibitive, 3 = Effect)</b>
4. Press [1], [2] or [3] to select type.	New type is entered in submaster status bar

Type changes do not take effect while the submaster is active. An active submaster's bump button LED blinks after you change its type. To deactivate it, move its slider to zero or to **10**.<sup>1</sup>

---

<sup>1</sup>. See [Submaster LEDs, page 156](#), for more information about the LED.

## **Submaster pages**

Express has ten pages of submasters. A page is a block of console memory that contains one set of recorded submasters, corresponding to the submaster sliders. The ten pages of memory increases the number of possible submasters to 240.

The console displays the message **Sub page 1 (2, 3...)** in the upper left corner of the display to indicate the current submaster page. To switch from one page to the other, press [Page], enter the desired page number, and press [Enter].

When you switch submaster pages, any submasters on stage remain on stage until you move their sliders to the home position. Until the new submaster loads, submaster LEDs flash slowly, indicating that the submaster on stage is from the previously loaded page. When you move the slider to its home position the new submaster is loaded and the LED stops flashing. This prevents the stage from going black or changing levels when you switch pages. (Fast flashes designate a submaster with a dwell time of **Hold**. See [Submaster LEDs, page 156](#) for more information about LEDs.)

*Note: When you read a new show into the console from a disk, the console loads the same page number that was loaded from the previous show. Any submasters on stage when you read a new show into the console remain on stage until you move their sliders to the home position. Until the new submaster loads, submaster LEDs flash, indicating that the submaster on stage is from the previously loaded show. When you move the slider to its home position the new submaster is loaded and the LED stops flashing.*

## ***Submaster bump buttons***

A bump button is located immediately below each submaster slider. The bump button's function depends on its status (see below) and on whether the submaster has a programmed fade.

If the submaster does not have a programmed fade, the bump button allows you to bring up the submaster's contents on stage instantly. Press the bump button to raise the submaster to its full recorded level. Hold the button to maintain the levels on stage. Release the button to remove the submaster's levels.

If the submaster has a programmed fade, the bump button allows you to start the fade, or to reverse the direction of an ongoing fade. Press the bump button to start the upfade. Press the button again to interrupt the upfade and start the downfade.

### ***Bump button status***

Submaster bump buttons may be individually enabled, disabled or placed in Solo mode. An enabled bump button functions normally, a disabled button doesn't function at all, and a button in Solo mode brings its channels to their recorded level and reduces all other channels to zero.

If a submaster's bump button is disabled or in Solo mode a **D** or an **S** appears next to the submaster's number on the Playback Submaster List and the Status Bar.

To set a bump button's status, follow these steps:

<b>Keystrokes:</b>	<b>Action:</b>
1. Press [Blind].	Selects Blind display mode
2. Press [Sub] [5].	Selects submaster 5
3. Press [S7], <b>More Softkeys</b> , [S1], <b>Bump Status</b> .	Prompt reads: <b>Select bump status and press ENTER (1 = enabled, 2 = disabled, 3 = solo)</b>
4. Press [2].	Selects <b>disabled</b> . The keypad corner indicates the choice you have made
5. Press [Enter].	Submaster 5's bump button is disabled

## Submaster LEDs

Each submaster bump button contains an LED. The state of the LED indicates the current state of that submaster, as shown in the chart below:

<b>Color</b>	<b>State</b>	<b>Meaning</b>
—	Off	Submaster not loaded.
Green	Solid	Submaster loaded.
Green	Slow Blink	New submaster. Loads when slider reaches home position.
Green	Fast Blink	Submaster on timed hold. Press bump button to begin downfade.

If the LED on a slider is blinking slowly, it means that you have changed pages and a new submaster is waiting to load. The old submaster stays loaded until you move the slider to the home position. When the slider reaches home, the channel levels from the new page replace the old levels.

*Note: If a submaster slider has both a submaster loading and a submaster on hold, the submaster on hold takes priority and the LED blinks fast. Press the bump button to downfade the old submaster.*



## Recording submasters

You can create submasters in Stage or Blind mode. Follow these steps to record a simple, pile-on submaster:

Keystrokes:	Action:
1. Press [Stage].	Selects Stage display mode
2. Select channels and set channel levels.	Creates look
3. Press [Record].	Prompt reads: <b>To record cue, select number and press ENTER</b> <b>To cancel, press CLEAR</b>
4. Press [Sub] [5] [Enter] or... Press Submaster 5's bump button.	The current stage look is recorded into submaster 5

*Note: Use Solo to record specific channels into the submaster (rather than the full stage look). For example: [5] [Thru] [1][0] [S7], **More Softkeys**, [S3], **Solo**, [Solo] [Record] [Sub] [5] [Enter] records only the current levels of channels 5 through 10 in submaster 5, regardless of what other channel levels may be up on stage.*

## Fade and dwell times for submasters

Normally, pressing a sub bump brings channel levels to their recorded level immediately. Channels stay at full recorded levels as long as the bump button is held.

You can also set upfade, dwell and downfade times for submasters. These times are activated for each submaster by its bump button. Upfade time is the length of time it takes a submaster's channels to fade to their recorded levels when the submaster bump button is pressed. Dwell time is the length of time the submaster's channel levels stay at their full recorded levels before the downfade starts. A manual dwell time means that you can override the bump button fades with the slider (see [Controlling submaster fades manually, page 167](#) for more information). Downfade time is the length of time it takes a submaster's channels to fade from their recorded levels to zero.<sup>2</sup>

Fade times may be programmed from 0.1 seconds to 99:59 minutes. The number may be entered in normal time format or in decimal format. When entered with a decimal point, the number must be less than one minute (0.1 to 59.9 seconds) to be accepted. When entered without a decimal point, a 2-digit number will be treated as seconds if less than 60 and as a calculated value of minutes and seconds if between 60 and 99. For example, if you enter 70, the time will display as 1:10. If you enter either a 3-digit or a 4-digit number, the last two digits, up to 59, are interpreted as seconds. For example, if you enter 9930, the time will display as 99:30.

---

<sup>2</sup> Defaults for upfade/dwell/downfade dwell times are 0/Manual/0. These default times are true for pile-on or inhibitive submasters, but not for effect submasters. See [Effect fade times, page 214](#).

## ***Adding fade and dwell times***

You can add fade and dwell times to a submaster from Stage or Blind mode. To add fade times to a submaster, follow these steps in either mode:

### **Keystrokes:**

1. Press [Sub].
2. Press [5].
3. Press [Time].
4. Use keypad to enter upfade time and press [Time].
5. Use keypad to enter dwell time and press [Time].  
(See next page for information about using a **Hold** dwell.)
6. Use keypad to enter downfade time and press [Enter].

### **Action:**

- Prompt reads:  
**Select submaster number**  
**To select submaster type, press TYPE**
- Selects submaster 5  
Corner reads:  
**Sub 5**
- Prompt reads:  
**Enter upfade time**
- Prompt reads:  
**Enter dwell time**  
**(For hold or manual operation, press CLEAR until desired setting appears)**
- Prompt reads:  
**Enter downfade time**
- New fade times are recorded into submaster 5

*Note: Once a timed submaster is running, press the bump button to change the direction of the fade. For example, if the upfade is half finished, pressing the bump button starts the downfade from 50 percent. If a downfade is running, pressing the bump button begins an upfade again from the current level.*

## ***Hold dwell time***

If you record a submaster with a dwell time of **Hold**, the submaster fades up when you press the bump button, then holds until you press it again.

To add a dwell time of **Hold** to a submaster, follow these steps:

<b>Keystrokes:</b>	<b>Action:</b>
1. Press [Sub].	Prompt reads: <b>Select submaster number To select submaster type, press TYPE</b>
2. Press [5].	Selects submaster 5 Corner reads: <b>Sub 5</b>
3. Press [Time] [Time].	Prompt reads: <b>Enter dwell time (For hold or manual operation, press CLEAR until desired setting appears)</b>
4. Press [Clear].	Corner reads: <b>Dwell Hold</b>
5. Press [Enter] [Enter].	Dwell time is set to <b>Hold</b> for submaster 5

## ***Manual dwell time***

If you record a submaster with a dwell time of **manual** and an upfade time other than zero, the upfade starts when you press and hold the bump button. It runs until channels reach full recorded levels, then holds at full as long as you hold the bump button; the downfade begins when you release it. If you don't hold the bump button for the duration of the upfade time, channels do not reach their full recorded levels.

Follow this procedure in Blind to convert a timed dwell to a manual dwell.<sup>3</sup>

<b>Keystrokes:</b>	<b>Action:</b>
1. Press [Blind] [Sub].	Prompt reads: <b>Select submaster number To select submaster type, press TYPE</b>
2. Press [5].	Selects submaster 5 Corner reads: <b>Sub 5</b>
3. Press [Time] [Time].	Prompt reads: <b>Enter dwell time (For hold or manual operation, press CLEAR until desired setting appears)</b>
4. Press [Clear] [Clear].	Corner reads: <b>Dwell Man</b>
5. Press [Enter] [Enter].	Dwell time is set to <b>Manual</b> for submaster 5

## ***Adding a rate to a submaster***

Rate allows you to record submasters that play back faster or slower than their recorded fade times. This can be especially helpful when you are trying to calculate complex timing information for effects loaded to a submaster.

*Note: If you adjust the rate on a submaster containing an effect, the rate adjustment affects individual step timing but does not change the overall effect timing.*

Rate is expressed as a percentage. A submaster with a rate of 100 plays back at its recorded fade time. A rate of 300 plays the submaster back three times faster than its recorded fade time. A rate of 50 causes it to play back half as fast as its recorded fade time. You may assign a rate of up to 2,000 percent.

To add a rate to submaster 7, follow these steps:

<b>Action:</b>	<b>Keystrokes:</b>
1. Press [Blind].	Selects Blind display mode
2. Press [Sub] [7].	Prompt reads: <b>Select submaster number</b> <b>To select submaster type, press</b> <b>TYPE</b>
3. Press [S5], <b>Rate</b> .	Prompt reads: <b>Use keypad to select submaster rate</b> <b>(0 to 2000, 100 = Normal)</b>
4. Press [1][5][0].	Corner reads: <b>Rate 150</b>
5. Press [Enter].	Rate of 150 percent is recorded into submaster 7

---

<sup>3.</sup> *If you do not enter a dwell time for a submaster, the submaster defaults to a manual dwell.*

## Specifying a submaster's page

You may specify the page to which you record submasters. For example, if page 1 is loaded, you can record a submaster to page 2. To do so, follow these steps:

Keystrokes:	Action:
1. Create a look in Stage.	
2. Press [Record] [Sub].	Prompt reads: <b>To record submaster, press BUMP or select number and press ENTER</b> <b>To cancel, press CLEAR</b>
3. Press [Page] [2].	Prompt reads: <b>Select page on which to record submaster, then press submaster bump button</b>
4. Press submaster 6's bump button.	Current levels are recorded into submaster 6 on submaster page 2

## Using Except to record a submaster

The console allows you to program a submaster containing all the current levels on stage except for those contributed by a specific cue, group, or another submaster.<sup>4</sup>

This example illustrates how you record a submaster without including levels contributed by the specified submaster.

Keystrokes:	Action:
1. Press [Stage].	Selects Stage display mode
2. Select desired channels and set channel levels.	
3. Press [Record] [Sub].	Prompt reads: <b>To record submaster, select number and press ENTER</b> <b>To cancel, press CLEAR</b>
4. Press [5].	Selects submaster 5 to be recorded
5. Press [Except] [Sub] [3]. <sup>a</sup>	Instructs that levels raised by submaster 3 be ignored Prompt reads: <b>Select excepted submaster number</b>
6. Press [Enter].	Records submaster 5 minus submaster 3's levels

<sup>a</sup> Press [Cue] or [Group] in place of [Sub] in step 5 to leave out the channels supplied by a cue or group.

---

<sup>4</sup> [Except] will not work with effect cues or effect submasters.

# Inhibitive submasters

## Creating

Inhibitive submasters allow you to limit the output of a group of channels. Channel outputs are limited to the level at which you set the slider. An inhibitive submaster set at **10** (100 percent), does not affect channel output. An inhibitive submaster controls the levels of its assigned channels in the same way the Grandmaster controls the levels of all channels.

*Note: If channels that you expect to see on stage are missing or at the wrong levels, check to see if a submaster is inhibiting them. If a channel is fully inhibited by a submaster, its level will be displayed as a yellow zero.*

Follow these steps to create and add channels to an inhibitive submaster:

<b>Keystrokes:</b>	<b>Actions:</b>
1. Press [Stage].	Selects Stage display
2. Press [Sub] and enter the number of the submaster (1 to 24) you wish to be inhibitive.	Selects sub to change Prompt reads: <b>Select submaster number</b> <b>To select submaster type, press</b> <b>TYPE</b>
3. Press [Type] [2].	Specifies sub is inhibitive Prompt reads: <b>Select submaster type</b> <b>(1 = Pile-on, 2 = Inhibitive, 3=Effect)</b>
4. Press [1][0] [Thru] [2][0].	Adds channels 10 through 20 to the sub
5. Press [Record] [Sub] [Enter].	Records new inhibitive sub

Follow the same procedure to convert back to pile-on.

- You may include the same channel in more than one inhibitive submaster.
- If you press an inhibitive submaster's bump button, the submaster fades from its current slider location to zero and back, using its recorded fade times.

## ***Adding channels***

Once you have an inhibitive submaster, use the following procedure in Blind to add channels to it.

<b>Keystrokes:</b>	<b>Actions:</b>
1. Press [Blind].	Selects Blind display
2. Press [Sub] [1][5] [Enter].	Selects sub 15. All channels in sub 15, if an inhibitive submaster, are displayed with "IN" in their level fields. Prompt reads: <b>Select channel numbers</b>
3. Press [5][2] [Enter].	Adds channel 52. The channel is shown with "IN" in its level field. Specifies sub is inhibitive
4. Press [Record][Sub] [Enter].	Records sub 15 with the added channel

## ***Deleting channels***

Channels may be deleted from an inhibitive submaster either in Stage or Blind. Follow the procedure below to delete in Blind.

<b>Keystrokes:</b>	<b>Actions:</b>
1. Press [Blind].	Selects Blind display
2. Press [Sub] [1][5] [Enter].	Selects sub 15. All channels in sub 15, if an inhibitive submaster, are displayed with "IN" in their level fields. Prompt reads: <b>Select channel numbers</b>
3. Press [5][2] [Clear].	Clears channel 52.
4. Press [Record][Sub] [Enter].	Records sub 15 without channel 52

## ***Modifying submasters in Blind***

To modify a submaster in Blind, follow these steps:

<b>Keystrokes:</b>	<b>Actions:</b>
1. Press [Blind].	Selects Blind display
2. Press [Sub] [1].	Prompt reads: <b>Select submaster number</b> <b>To select submaster type, press TYPE</b>
3. Press [Enter].	Brings up current level settings for submaster 1 Prompt reads: <b>Select channel numbers</b>
4. Enter channel numbers and set desired new levels.	Sets new levels
5. Press [Record].	Prompt reads: <b>To record submaster, select number and press ENTER</b> <b>To cancel, press CLEAR</b>
6. Press [Enter].	Changes to submaster 1 are recorded

## ***Modifying submasters in Stage***

### ***Re-recording submasters***

To modify a submaster in Stage with Record, follow these steps:

<b>Keystrokes:</b>	<b>Actions:</b>
1. Press [Stage].	Selects Stage display
2. Use the submaster slider to raise submaster 2 to full on stage.	Submaster 2's channels rise on stage to recorded levels
3. Enter channel numbers and set desired new levels.	New levels are set on stage
4. Press [Record], then press submaster 2's bump button.	Submaster 2 is recorded with the new levels. Submaster LED blinks, indicating that submaster 2 has been changed and the changes have not been loaded
5. Press [Rel].	Releases newly set levels
6. Slide submaster slider to zero, then back to full.	Loads submaster 2's new levels and brings them up on stage



## Updating submasters

Update allows you to modify previously recorded cues, groups, submasters or focus points in Stage. Update takes levels from all captured and selected channels, and those selected may be restricted with the Only command.<sup>5</sup>

### Updating an active submaster

The following procedure illustrates how to update a submaster that has been brought up on Stage. Note that you can update all submasters at once by entering 0 instead of a submaster number in step 4 below. No new channels are added when updating all submasters at once.

Keystrokes:	Action:
1. Press [Stage].	Selects Stage display mode
2. Set submaster 6's slider to 10. <sup>a</sup>	Puts submaster 6's full look on stage
3. Modify channel levels as desired.	Sets submaster levels or selects additional channels and sets their levels
4. Press [S2], <b>Update</b> , [Sub].	Prompt reads: <b>To update submaster, press bump or select number and press ENTER</b> <b>Press 0 + ENTER to select all submasters (only those channels already in sub)</b>
5. To restrict channels in the update, use Only here. <sup>b</sup>	Selects channels to update Prompt reads: <b>Select channel numbers</b> <b>To cancel, press CLEAR</b>
6. Press submaster 6's bump button.	Updates submaster 6

<sup>a</sup> You cannot update a channel in a submaster to a level higher than the submaster slider's level. For example, if you have the slider set to 5, the highest level to which you can update the sub is 50.

<sup>b</sup> If not restricted with Only, all captured and selected channels are included in the update.

---

<sup>5</sup> For an explanation of captured channels, see [Channel modes, page 52](#). For an explanation of Only, see [The Only command, page 8](#).

## Updating a recorded submaster

You need not bring up the submaster to update it. The following procedure illustrates how to update any recorded submaster.

Keystrokes:	Action:
1. Press [Stage].	Selects Stage display mode
2. Press [S8], <b>Fixture</b> , [1] [Thru] [8], [Full].	Selects fixtures 1 through 8 and sets their intensities to full
3. Set the pan and tilt levels. <sup>a</sup>	Sets levels for fixture 8 pan and tilt attributes
4. Press [S2], <b>Update</b> , [Sub].	Prompt reads: <b>To update submaster, press BUMP or select number and press ENTER</b> <b>Press 0 + ENTER to select all submasters (only those channels already in sub)</b>
5. Press [Page] [3].	Selects submaster page 3 Prompt reads: <b>Select submaster page to update and press ENTER or submaster BUMP</b> <b>To cancel, press CLEAR</b>
6. To restrict channels in the update, use Only as explained under <a href="#">The Only command, page 8</a> . <sup>b</sup>	Selects channels to update Prompt reads: <b>Select channel number(s) -</b> <b>To cancel, press CLEAR</b> <b>(Press 0 to reselect all non-zero channels)</b>
7. Press submaster 6's bump button.	Updates submaster 6 on submaster page 3

<sup>a.</sup> Use your trackpad.

<sup>b.</sup> Optional step.

## ***Live control of a submaster's rate***

In Stage mode, selecting a submaster and pressing [S5], **Rate**, allows the timing of the submaster to be controlled by the trackpad or by keyboard entry.

Follow these steps to change the rate of an active submaster in Stage. (This procedure also works if the submaster is not active. In either case, the new rate is automatically recorded in the submaster.)

<b>Keystrokes:</b>	<b>Action:</b>
1. Press [Stage].	Selects Live display
2. Press [Sub] [5].	Selects submaster 5
3. Press [S7], <b>More Softkeys</b> , until <b>Rate</b> appears at [S5].	
4. Press [S5], <b>Rate</b> .	Activates rate control Prompt reads: <b>Select submaster rate and press ENTER, or use wheel or trackpad to alter rate (0 to 2000, 100 = Normal)</b>
5. Move a finger on the trackpad. <sup>a</sup>	Sets and records fade rate for submaster 5. If submaster is running, fade proceeds at new rate
6. Press [Enter].	Accepts the new rate

<sup>a</sup> *When the submaster rate is controlled dynamically by the trackpad, the submaster number turns blue in the Submaster List. See [Submaster List, page 173](#), for more information.*

## ***Controlling submaster fades manually***

When you press the bump button on a timed submaster, recorded fade times play back as you recorded them. The console allows you to use the slider to take manual control of submasters recorded with fade times.

The Submaster List shows the progress of the submaster's fade. To override the fade, push the submaster's slider to a higher level than the fade (lower, if inhibitive).

Once the slider passes the fade (or meets it at Full on pile-on submasters or zero on inhibitive submasters), control of the fade transfers to the slider and you have full manual control of the submaster. Move the slider to set the fade level.

## Labeling submasters

If you have Expression Off-Line, you may assign labels to your submasters.<sup>6</sup> Submaster names can consist of any combination of letters, numbers and symbols, and may be up to 16 characters long.

Follow these steps to add the name “Bedroom wash” to submaster 4:

<b>Keystrokes:</b>	<b>Action:</b>
1. Press [Stage].	Selects Stage display
2. Press [Sub] [4].	Prompt reads: <b>Select submaster number To select submaster type, press TYPE</b>
3. Press [Label]. <sup>a</sup>	Prompt reads: <b>Type submaster name</b>
4. Use the alphanumeric keyboard to enter the label. Type <b>Bedroom wash</b> .	Corner reads: <b>Label: Bedroom wash</b>
5. On the console keypad, press [Enter].	Submaster 4 is labeled <b>Bedroom wash</b>

<sup>a</sup> *Not available on the Express console. You can type keyboard equivalent “B” in Expression Off-Line as a substitute for the Label key.*

---

<sup>6</sup> *For information about Expression Off-Line and how to order it, see [Expression Off-Line, page 306](#).*

## ***Copying submasters***

You can copy a look from a submaster to another submaster, to a cue, a group or a focus point. Follow the procedure below:

<b>Keystrokes:</b>	<b>Actions:</b>
1. Press [Blind].	Selects Blind display mode
2. Press [Sub].	Prompt reads: <b>Select submaster number</b> <b>To select submaster type, press TYPE</b>
3. Enter the number of the submaster you wish to copy.	Corner reads: <b>Sub 1</b>
4. Press [Record] [Sub]. <sup>a</sup>	Prompt reads: <b>To record submaster, select number and press ENTER</b> <b>To cancel, press CLEAR</b>
5. Enter the number of the new submaster.	Corner reads: <b>Sub 9</b>
6. Press [Enter]. Submaster copy is complete.	Contents of submaster 1 are copied to submaster 9

<sup>a</sup> To copy the submaster to a cue, group or focus point, press [Cue], [Group] or [Focus Point] in place of [Sub] in step 4.

## ***Loading cues or groups to submasters***

[Load Sub] allows you to load the contents of one or more recorded groups or cues into submasters.

To load a look from a range of cues or groups to submasters, follow these steps:

<b>Keystrokes:</b>	<b>Actions:</b>
1. Press [Load Sub].	Prompt reads: <b>Select submaster(s) to load</b> <b>To cancel, press CLEAR</b>
2. Press [9] [Thru] [1][2].	Selects submasters 9 through 12 Corner reads: <b>Sub 12</b>
3. Press [Cue] (or [Group]).	Prompt reads: <b>Select cue(s) to load into submaster(s)</b> <b>To cancel, press CLEAR</b>
4. Press [1] [And] [3] [Thru] [5].	Selects cues 1, 3, 4, and 5 to copy to submasters 9 through 12 Corner reads: <b>Cue 5</b>
5. Press [Enter]. Submaster copy is complete.	Contents of cues 1, 3, 4, and 5 are copied to submasters 9, 10, 11, and 12, respectively

## ***Copying cues or groups to submasters***

To copy a look from a cue or a group to a submaster, follow these steps:

<b>Keystrokes:</b>	<b>Actions:</b>
1. Press [Blind].	Selects Blind display mode
2. Press [Cue] (or [Group]).	Prompt reads: <b>Select cue number</b> <b>To select cue type, press TYPE</b>
3. Press [1].	Selects cue to copy Corner reads: <b>Cue 1</b>
4. Press [Record] [Sub].	Prompt reads: <b>To record submaster, select number and press ENTER</b> <b>To cancel, press CLEAR</b>
5. Press [9].	Selects submaster 9 Corner reads: <b>Sub 9</b>
6. Press [Enter]. Submaster copy is complete.	Contents of cue 1 are copied to submaster 9

## ***Clearing submasters***

You must be in Blind or Stage display mode to clear the contents of individual submasters. This process erases all level setting instructions and attributes from the submaster. To clear all submasters, use the Clear Submasters option from the Clear Functions menu as described in [Clear and reset options, page 255](#).

To clear submasters, follow these steps:

<b>Keystrokes:</b>	<b>Actions:</b>
1. Press [Blind].	Selects Blind display
2. Press [Sub].	Prompt reads: <b>Select submaster number</b>
3. Press [S6], <b>Delete Sub</b> .	Prompt reads: <b>To delete submaster(s), select number(s) and press ENTER</b> <b>To cancel, press CLEAR</b>
4. Enter the number of the submaster you want to clear.	Corner reads: <b>Sub 2</b>
5. Press [Enter].	Prompt reads: <b>To confirm, press ENTER</b> <b>To cancel, press CLEAR</b>
6. Press [Enter] to delete the submaster or [Clear] to cancel the action.	Contents of submaster 2 are cleared

# Chapter 14

## *Lists and spreadsheets*

You can display lists of cues, submasters, groups and focus points on the monitor using a softkey in the Blind display.<sup>7</sup> These lists allow you to change the timing of cues and submasters and label items on the list.<sup>8</sup> They also allow you to delete items from a list.

Also available by softkey from the Blind display are spreadsheets for cues, submasters, groups and focus points. Spreadsheets allow you to add or delete items from the list, such as to create new cues or groups.

Following are the topics included in this chapter:

- Cue List
- Submaster List
- Group List
- Focus Point list
- Editing in lists
- Cue, Submaster, Group and Focus Point spreadsheets
- Editing in spreadsheets

---

<sup>7.</sup> *Sub List can also be displayed with a softkey in Stage.*

<sup>8.</sup> *You may assign labels in lists with Expression Off-Line using the keyboard equivalent "B". See [Expression Off-Line, page 306](#), for details.*

## Cue List

The Cue List allows editing of upfade, downfade and wait times; link and follow settings; rate; and cue label.<sup>9</sup> This list also allows you to delete cues from your show.

Up to 18 cues are displayed on this Cue List at one time. Screens can be paged if there are more than 18 cues in the show. Press [Blind] [S2], **Cue List**, to display the Cue List.



## Editing cues

Edit one cue or multiple cues at a time in the Cue List with the following procedure. Changes made are recorded immediately.

### Keystrokes:

1. Press [Blind].
2. Press [S2], **Cue List**.
3. Press [1] [Thru] [3].
4. Press [→] until the cursor reaches the attribute you wish to edit.<sup>a</sup>
5. Enter the new setting for the attribute and press [Enter].

### Action:

- Selects Blind display
- Displays Cue List
- Selects cues 1, 2 and 3  
Prompt reads:  
**Select cue number(s)**
- The prompt indicates your options or prompts you to enter a new setting
- Changes the cue

<sup>a</sup> Alternatively, you may press [Type], [Time], [Link], [Follow] or [Wait] keys to enter the field you want. You cannot gain access to the label field from the console. In Expression Off-Line, type the keyboard equivalent "B" to enter the label field.

<sup>9</sup> Use keyboard equivalent "B" in Expression Off-Line to assign labels. See [Expression Off-Line, page 306](#), for details.



## Submaster List

The Submaster List allows editing of bump button status; upfade, downfade and dwell times; type; rate and label.<sup>10</sup> This list also allows you to delete submasters from your show.

Enter the Submaster List from softkeys in either Blind or Stage. In Blind, press [Sub] [S2], **Sub List**. In Stage, press [Sub] [S7], **More Softkeys**, [S2], **Sub List**.

Sub	Page	%	Bump	Up	Dwell	Down	Type	Rate	Label
1	2	60		0	Man	0			
2	2	40		0	Man	0			
3	1		D	5	10	5	Pile-on	200	Double-time
4	1			0	Man	0			
5	1			0	Man	0			
6	1			0	Man	0			
7	1			0	Man	0			
8	1			0	Man	0			
9	1			0	Man	0			
10	1			0	Man	0			
11	1			0	Man	0			
12	1			0	Man	0			
13	1		S	8	Man	8	Inhibit		
14	1			0	Man	0			
15	1			0	Man	0			
16	1			0	Man	0			
17	1			0	Man	0			

Select submaster number(s)

S1 Bump Status   S2 Hold   S3 Rate   S4 Previous Page   S5 Next Page   S6 Delete Sub   S7   S8 Return

The first 17 submasters are shown initially in the Submaster List. Page through the rest of the submasters using the [S5], **Next Page** and [S4], **Previous Page**, keys.





Unrecorded submasters are shown with a gray number in the Sub (first) column. A recorded pile on submaster has a green Sub number; an inhibitive submaster has a red Sub number; an effect submaster has a white Sub number. The Submaster List on the playback monitor has the same color coding.

The currently selected submaster page is shown following the words "Sub Page" at the top left of the display. Change submaster pages as explained in [Specifying a submaster's page, page 161](#). In general, the Page Loaded shown in column two will agree with Sub Page except for those submasters that were on stage when the current Sub Page was selected (see [Submaster pages, page 154](#)). The column marked "%" shows the submaster's current level on stage as determined by its slider.

<sup>10</sup> Use keyboard equivalent "B" in Expression Off-Line to assign labels. See [Expression Off-Line, page 306](#), for details.

Note the following with regard to defaults in the Submaster List display:

- Pile-on is the default type for a newly defined submaster.
- Bump status does not display unless changed from the default, which is "enabled."
- Dwell time defaults to "manual."
- Rate does not display unless changed from the default, which is 100.

Navigation and Feedback - Submaster List					
		[S]			
Select a submaster	X		X		X
Select a field		X		X	
White row	selected submaster				
Yellow field	selected field				

## Editing submasters

Changes made to a submaster in the Submaster List are immediately recorded. Edit in the Submaster List as follows.<sup>11</sup>

### Keystrokes:

1. Press [Blind].
2. Press [Sub] [S2], **Sub List**.
3. Press [1][3] [Enter].
4. Press [1] [Enter].<sup>a</sup>
5. Press [5] [Enter].
6. Press [1][5] [Enter].

### Actions:

- Selects Blind display
- Displays Submaster List  
**Select submaster number(s)**
- Selects submaster 23. Prompt reads:  
**Select bump status and press ENTER**  
**(1=enabled, 2=disabled, 3=solo)**
- Enables bump status for the submaster. Prompt reads:  
**Enter upfade time**
- Specifies 5 second upfade time  
Prompt reads:  
**Enter dwell time**  
**(For hold or manual operation, press CLEAR until desired setting appears)**
- Specifies 15 seconds dwell time  
Prompt reads:  
**Enter downfade time**

<sup>a</sup> If not changing the bump status, for example if the submaster is already enabled, you may just press [Enter].

<sup>11</sup> Alternatively, you may press [Type] or [Time] keys to reach the field you want.

- |     |   |   |
|-----|---|---|
| 7.  | Press [5] [Enter].                                  | Specifies 5 second downfade time<br>Prompt reads:<br><b>Select submaster type<br/>(1=Pile-on, 2=Inhibitive, 3=Effect)</b>   |
| 8.  | Press [2] [Enter].                                  | Specifies inhibitive type. Prompt reads:<br><b>Use keypad to select submaster rate<br/>(0-2000, 100=Normal)</b>   |
| 9.  | Press [2][0][0] [Enter]. <sup>a</sup>               | Specifies rate 200. Prompt reads:<br><b>Select submaster numberType<br/>submaster label<br/>(F6=clear to end,<br/>F7=previous submaster level,<br/>F8=next submaster label)</b> |
| 10. | Enter your label on the keypad, then press [Enter]. | Labels submaster 23   |

<sup>a</sup> You cannot gain access to the label field from the console. In Expression Off-Line, type the keyboard equivalent "B" here instead of [Enter] to produce the prompt shown in Step 9 and to enter the label field.

## ***Deleting submasters***

All recorded information can be removed for one or more submasters using the Submaster List. Follow the procedure below.

- | <b>Keystrokes:</b>                               | <b>Action:</b>   |
|--|--|
| 1. Press [Blind] [Sub] [S2],<br><b>Sub List.</b> | Displays Submaster List. Prompt reads:<br><b>Select submaster number(s)</b>  |
| 2. Press [S6], <b>Delete Sub.</b>                | Prompt reads:<br><b>Top delete submaster(s), select<br/>number(s) and press ENTER<br/>to cancel, press CLEAR</b>       |
| 3. Press [5][And][7] [Enter].                    | Specifies submasters 5 and 7 to be deleted. Prompt reads:<br><b>To confirm, press ENTER<br/>To cancel, press CLEAR</b> |
| 4. Press [Enter].                                | Deletes submasters 5 and 7   |

## Group List

The Group list shows all the recorded groups in the show by number and label. The list can be paged if there are more than 54 groups in the show (18 groups shown per column). Groups may be labeled in the Group list<sup>12</sup> or deleted there from the show, either individually or in ranges.

In the Group List display, a selected group is identified by a highlighted white row and a selected field is highlighted in yellow.



### Labeling a group

If you have Expression Off Line, follow this procedure to label a group in the Group List display.<sup>13</sup>

#### Keystrokes:

1. Press [Blind] [Group] [Enter] [S2], **Group List**.
2. Press [4] [B].
3. Enter your label, then press [Enter].

#### Action:

- Displays Group List  
Prompt reads:  
**Select group number(s)**
- Selects group 4  
Prompt reads:  
**Type group label**  
**(F6=clear to end,**  
**F7=previous group level,**  
**F8=next group label)**
- Completes labeling of group 4

<sup>12.</sup> You can label with Expression Off-Line, not the console.

<sup>13.</sup> See [Expression Off-Line, page 306](#), for more information about this program.

## Deleting a group

Follow this procedure to delete one or more groups in the Group List display.

### Keystrokes:

1. Press [Blind] [Group] [Enter] [S2], **Group List**.
2. Press [S6], **Delete Group**.
3. Press [4] [And] [5] [Enter] [Enter].

### Action:

- Displays Group List  
Prompt reads:  
**Select group number(s)**
- Prompt reads:  
**To delete group(s), press number(s) and press ENTER**  
**To cancel, press CLEAR**
- Deletes groups 4 and 5  
Prompt reads:  
**Select group numbers(s)**

## Focus Point List

The Focus Point list shows all the focus points in the show by number and label. The list can be paged if there are more than 54 focus points in the show (18 focus points shown per column). Focus points may be labeled in the Focus Point List<sup>14</sup> or deleted there from the show, either individually or in ranges.

In the Focus Point List display, a selected focus point is identified by a highlighted white row and a selected field is highlighted in yellow.



<sup>14</sup>. You can label with Expression Off-Line, not the console.

## ***Labeling a focus point***

If you have Expression Off Line, follow this procedure to label a focus point in the Focus Point List display.<sup>15</sup>

<b>Keystrokes:</b>	<b>Action:</b>
1. Press [Blind] [Focus Point] [Enter] [S2], <b>Focus List</b> .	Displays Focus Point List Prompt reads: <b>Select focus point number(s)</b>
2. Press [4] [B].	Selects focus point 4 Prompt reads: <b>Type focus point label (F6=clear to end, F7=previous focus point level, F8=next focus point label)</b>
3. Enter your label, then press [Enter].	Completes labeling of focus point 4

## ***Deleting a focus point***

Follow this procedure to delete one or more focus points in the Focus Point List display.

<b>Keystrokes:</b>	<b>Action:</b>
1. Press [Blind] [Focus Point] [Enter] [S2], <b>Focus List</b> .	Displays Focus Point List Prompt reads: <b>Select focus point number(s)</b>
2. Press [S6], <b>Delete Focus</b> .	Prompt reads: <b>To delete focus point(s), press number(s) and press ENTER To cancel, press CLEAR</b>
3. Press [4] [And] [5] [Enter] [Enter].	Deletes focus points 4 and 5 Prompt reads: <b>Select focus point numbers(s)</b>

---

<sup>15</sup>. See [Expression Off-Line, page 306](#), for more information about this program.

## Working in spreadsheets

Cues, submasters, groups and focus points each have their own spreadsheets. You can modify or delete in all spreadsheets and create in all but the submaster spreadsheet. Channels and groups may be added to all spreadsheets singly or in multiples or ranges. Channels may be set at focus points and focus points may be added, singly and in multiples or ranges, in all but the focus point spreadsheet.

In spreadsheets, it is not necessarily to press [Record] to record changes. These changes are made immediately, but they don't update in any cue, submaster, group or focus point already displayed on stage until these are replaced on stage.

### Cue spreadsheet

In the cue spreadsheet, you have the option of tracking any cues you create or modify. Press [Blind] [S3], **Spreadsheet**, to go to the cue spreadsheet.

The screenshot displays the 'Cue Spreadsheet' interface. At the top, it shows 'Spreadsheet' and '01:22 PM' in cyan, and 'Chan' in a blue box. Below this, 'Track Disabled' is written in yellow. The main area is a table with 'Cue' on the left and 'Channels' across the top. The table contains three rows of data for cues 100, 101, and 103. Cue 100 has 'FL' in channel 08 and 'FL' in channel 18. Cue 101 has '04 34 04 71' in channels 04-07, 'FL' in channel 08, '04 34 04 71' in channels 11-14, 'FL' in channel 18, and '04' in channel 21. Cue 103 has '02 23 03 00 00' in channels 02-05, '00 00 00 00 00' in channels 06-10, '03 85 03 86 00' in channels 11-15, '00 00 00 00 00' in channels 16-20, and '00' in channel 21. Below the table, a red prompt 'Select channel(s)' is shown. At the bottom, there is a control bar with eight buttons labeled S1 through S8: 'Select Cue', 'Create Cue', 'Replace Level', 'Previous Page', 'Next Page', 'Delete Cue', 'Enable Tracking', and 'Return'.

Cue	01	02	03	04	05	06	07	08	09	10	11	12	13	14	15	16	17	18	19	20	21
100								FL										FL			
101		04	34	04	71			FL			04	34	04	71				FL			04
103		02	23	03	00	00	00	00	00	00	03	85	03	86	00	00	00	00	00	00	00
	01	01	01	01	01	01	01	01	01	01	01	01	01	01	01	01	01	01	01	01	01

## Creating cues

Cues may be created in the cue spreadsheet with or without tracking enabled. After entering the cue spreadsheet as explained on the previous page, create a cue with the tracking option enabled as follows.

Keystrokes:	Actions:
1. Press [S7], <b>Enable Tracking</b> . <sup>a</sup>	Sets tracking enabled
2. Press [S2], <b>Create Cue</b> .	Prompt reads: <b>To create a new cue, select cue number and press ENTER</b> <b>To cancel, press CLEAR</b>
3. Press [5] [Enter].	Selects cue 5. Prompt reads: <b>Select channel(s)</b>
4. Press [5] [Thru] [1][0].	Selects channels to include
5. Press Full].	Sets channels 5 through 10 to full Prompt reads: <b>Enter intensity</b>
6. Repeat steps 4-5.	Continue selecting channels and setting levels until done

<sup>a</sup> Use either the [Track] key or the cue spreadsheet softkey to toggle the tracking mode. Press once or twice until the yellow message in the upper right corner of the spreadsheet display confirms your choice.

## Editing cues

Follow the procedure above for creating a cue in spreadsheet except press [S1], **Select Cue**, rather than softkey [S2] in step 2.

## Deleting cues

In the cue spreadsheet, delete one or more cues as follows.

Keystrokes:	Actions:
1. Press [S6], <b>Delete Cue</b> .	Prompt reads: <b>To delete cue(s), select number(s) and press ENTER</b> <b>To cancel, press CLEAR</b>
2. Press [5] [And] [6] [Enter].	Selects cues 5 and 6 Prompt reads: <b>To confirm, press ENTER</b> <b>To cancel, press CLEAR</b>
3. Press [Enter] [Enter].	Deletes cues 5 and 6



## ***Replacing channel level***

As a convenient editing technique, you may specify a particular level to change for a channel or number of channels. After entering the cue spreadsheet as explained earlier in this section, replace channel level as follows.

### **Keystrokes:**

1. Press [S1], **Select Cue**.
2. Press [5] [Enter].
3. Press [5] [Thru] [1][0] [S3], **Replace Level**, [5][0].
4. Press [Enter].
5. Press [Full] [Enter].

### **Actions:**

- Prompt reads:  
**Select cue(s)**
- Selects cue 5  
Prompt reads:  
**Select channel(s)**
- Selects channels 5 through 10 at level 50 to change  
Prompt reads:  
**Select level to replace and press ENTER**
- Prompt reads:  
**Select new level and press ENTER**
- Changes all channels in the range 5 through 10 with level 50 to level full

## Submaster spreadsheet

Press [Blind] [Sub] [S3], **Spreadsheet**, to go to the submaster spreadsheet.

Sub	01	02	03	04	05	06	07	08	09	10	11	12	13	14	15	16	17	18	19	20	21
1	FL	FL	FL	FL	FL	FL	FL	FL	FL	FL											
2	FL	FL	FL	FL	FL	FL	FL	FL	FL	FL											
3	FL	FL	FL	FL	FL	FL	FL	FL	FL	FL	50	50	50	50							
4																					
5																					
6																					
7																					
8																					

Select channel(s)

S1 Select Sub   S2   S3 Replace Level   S4 Previous Page   S5 Next Page   S6 Delete Sub   S7   S8 Return

## Editing submasters

After entering the submaster spreadsheet as explained above, edit a submaster with the following procedure.

### Keystrokes:

1. Press [S1], **Select Sub**.
2. Press [5] [Enter].
3. Press [5] [Thru] [1][0].
4. Press [Full].
5. Repeat steps 3-4.

### Actions:

- Prompt reads:  
**Select submasters**
- Selects submaster 5  
Prompt reads:  
**Select channel(s)**
- Selects channels to include  
Prompt reads:  
**Select intensity**
- Sets channels 5 through 10 to full
- Continue selecting channels and setting levels until done

## ***Deleting submasters***

After entering the submaster spreadsheet as explained above, delete a submaster as follows.

### **Keystrokes:**

1. Press [S6], **Delete Sub**.
2. Press [5] [And] [6].
3. Press [Enter] [Enter].

### **Actions:**

Prompt reads:  
**To delete submaster(s), select number(s) and press ENTER**  
**To cancel, press CLEAR**

Selects submasters 5 and 6  
Prompt reads:  
**To confirm, press ENTER**  
**To cancel, press CLEAR**

Deletes submasters 5 and 6

## ***Replacing channel level***

As a convenient editing technique, you may specify a particular level to change for a channel or number of channels. After entering the submaster spreadsheet as explained on the previous page, replace channel level as follows.

### **Keystrokes:**

1. Press [S1], **Select Sub**.
2. Press [5] [Enter].
3. Press [5] [Thru] [1][0] [S3],  
Replace Level, [5][0].
4. Press [Enter].
5. Press [Full] [Enter].

### **Actions:**

Prompt reads:  
**Select submaster(s)**

Selects submaster 5  
Prompt reads:  
**Select channel(s)**

Selects channels 5 through 10 at level 50 to change  
Prompt reads:  
**Select level to replace and press ENTER**

Prompt reads:  
**Select new level and press ENTER**

Changes all channels in the range 5 through 10 with level 50 to level full

## Group spreadsheet

Go to the group spreadsheet as follows.

### Keystrokes:

1. Press [Blind] [Group] [Enter].
2. Press [S3], **Spreadsheet**.

### Actions:

- Selects the group mode of the blind display
- Shows the group spreadsheet

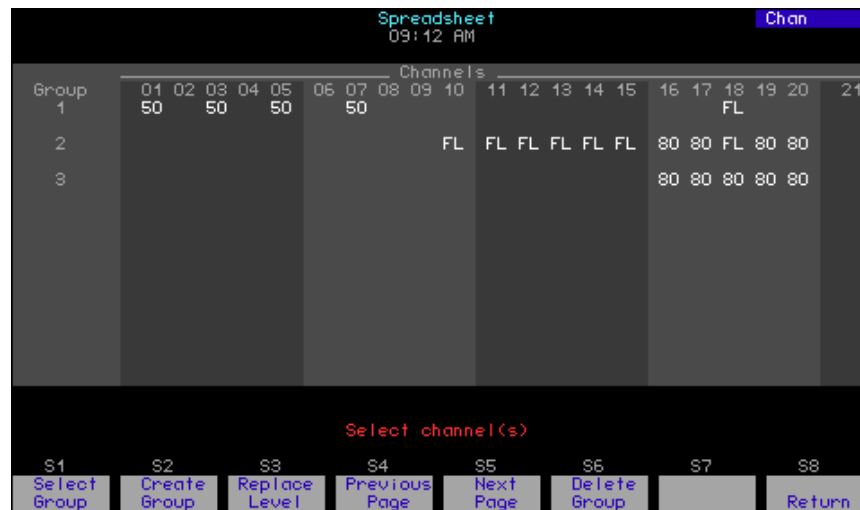

## Creating a group

After entering the group spreadsheet as explained above, create a group as follows.

### Keystrokes:

1. Press [S2], **Create Group**.
2. Press [5] [Enter].
3. Press [5] [Thru] [1][0].
4. Press [Full].
5. Repeat steps 3-4.

### Actions:

- Prompt reads:  
**To create a new group, select group number and press ENTER**  
**To cancel, press CLEAR**
- Selects group 5  
Prompt reads:  
**Select channel(s)**
- Selects channels to include
- Sets channels 5 through 10 to full  
Prompt reads:  
**Enter intensity**
- Continue selecting channels and setting levels until done

## ***Editing groups***

You may edit a group in the group spreadsheet. Follow all steps in the procedure under **Creating a group** on the previous page except Press [S1], **Select Group** in step 1.

## ***Deleting groups***

After entering the group spreadsheet as explained on the previous page, delete a group as follows.

<b>Keystrokes:</b>	<b>Actions:</b>
1. Press [S6], <b>Delete Group</b> .	Prompt reads: <b>To delete group(s), select number(s) and press ENTER</b> <b>To cancel, press CLEAR</b>
2. Press [5] [And] [6] [Enter].	Selects groups 5 and 6 Prompt reads: <b>To confirm, press ENTER</b> <b>To cancel, press CLEAR</b>
3. Press [Enter] [Enter].	Deletes groups 5 and 6

## ***Replacing channel level***

As a convenient editing technique, you may specify a particular level to change for a channel or number of channels. After entering the group spreadsheet as explained on the previous page, replace channel level as follows.

<b>Keystrokes:</b>	<b>Actions:</b>
1. Press [S1], <b>Select Group</b> .	Prompt reads: <b>Select group(s)</b>
2. Press [5] [Enter].	Selects group 5 Prompt reads: <b>Select channel(s)</b>
3. Press [5] [Thru] [1][0] [S3], Replace Level, [5][0].	Selects channels 5 through 10 at level 50 to change Prompt reads: <b>Select level to replace and press ENTER</b>
4. Press [Enter].	Prompt reads: <b>Select new level and press ENTER</b>
5. Press [Full] [Enter].	Changes all channels in the range 5 though 10 with level 50 to level full

## Focus point spreadsheet

Go to the focus point spreadsheet as follows.

- | <b>Keystrokes:</b>                      | <b>Actions:</b>                                   |
|---|---|
| 1. Press [Blind] [Focus Point] [Enter]. | Selects the focus point mode of the blind display |
| 2. Press [S3], <b>Spreadsheet</b> .     | Shows the focus point spreadsheet                 |

Focus	01	02	03	04	05	06	07	08	09	10	11	12	13	14	15	16	17	18	19	20	21	
1	50	50	50	50	FL	FL	FL	80	80	80	80	80	80	90	90	90						
2	50	50	50	50	FL	FL	FL	80	80	80	80	80	80	90	90	90						
10	15	62	05	78				FL			05	66	07	75				FL				10

Select channel(s)

S1 Select Focus	S2 Create Focus	S3 Replace Level	S4 Previous Page	S5 Next Page	S6 Delete Focus	S7	S8 Return
--------------------	--------------------	---------------------	---------------------	-----------------	--------------------	----	--------------

## Creating focus points

After entering the focus point spreadsheet as explained above, create a focus point as follows.

- | <b>Keystrokes:</b>                   | <b>Actions:</b>   |
|--------------------------------------|---|
| 1. Press [S2], <b>Create Focus</b> . | Prompt reads:<br><b>To create a new focus point, select focus point number and press ENTER</b><br><b>To cancel, press CLEAR</b> |
| 2. Press [5] [Enter].                | Selects focus point 5<br>Prompt reads:<br><b>Select channel(s)</b>  |
| 3. Press [5] [Thru] [1][0].          | Selects channels to include<br>Prompt reads:<br><b>Enter intensity</b>  |
| 4. Press [Full].                     | Sets channels 5 through 10 to full  |
| 5. Repeat steps 3-4.                 | Continue selecting channels and setting levels until done   |

## ***Editing focus points***

You may edit a focus point in the focus point spreadsheet. Follow all steps in the procedure under **Creating a focus point** on the previous page except Press [S1], **Select Focus** in step 1.

## ***Deleting in spreadsheet***

After entering the focus point spreadsheet as explained on the previous page, delete a focus point as follows.

<b>Keystrokes:</b>	<b>Actions:</b>
1. Press [S6], <b>Delete Focus</b> .	Prompt reads: <b>To delete focus point(s), select number(s) and press ENTER</b> <b>To cancel, press CLEAR</b>
2. Press [5] [And] [6] [Enter].	Selects focus points 5 and 6 Prompt reads: <b>To confirm, press ENTER</b> <b>To cancel, press CLEAR</b>
3. Press [Enter] [Enter].	Deletes focus points 5 and 6

## ***Replacing channel level***

As a convenient editing technique, you may specify a particular level to change for a channel or number of channels. After entering the focus point spreadsheet as explained on the previous page, replace channel level as follows.

<b>Keystrokes:</b>	<b>Actions:</b>
1. Press [S1], <b>Select Focus</b> .	Prompt reads: <b>Select focus point(s)</b>
2. Press [5] [Enter].	Selects focus point 5 Prompt reads: <b>Select channel(s)</b>
3. Press [5] [Thru] [1][0] [S3], Replace Level, [5][0].	Selects channels 5 through 10 at level 50 to change Prompt reads: <b>Select level to replace and press ENTER</b>
4. Press [Enter].	Prompt reads: <b>Select new level and press ENTER</b>
5. Press [Full] [Enter].	Changes all channels in the range 5 though 10 with level 50 to level full





# *Chapter 15*

## *Park*

Park allows you to set channels, dimmers and fixtures at levels that are maintained on stage. These levels are not recorded into cues and are independent of most other instructions, except as follows:

- [Blackout] will turn off parked dimmers, channels and fixtures unless they are independent channels.
- Channels parked at a focus point will update the parked levels if the levels change in the focus point.

If a dimmer is parked and the channel that controls it also is parked, the dimmer's parked level takes priority over the channel's parked level. If the dimmer is then unparked, the channel will revert to the channel's parked level. When a dimmer, channel or fixture is unparked, the levels revert to the level the console is currently assigning to it.

The following options are described in this chapter:

- Parking and unparking dimmers
- Parking and unparking channels
- Parking and unparking fixtures
- Parking channels and fixtures at a focus point
- Parking and unparking cues, submasters, groups and focus points

## Using the Park display

Illustrated below is the Park display that you reach with a softkey in the Stage display. The parked channels and dimmers are displayed in the Park display with their levels and focus point links, if any.

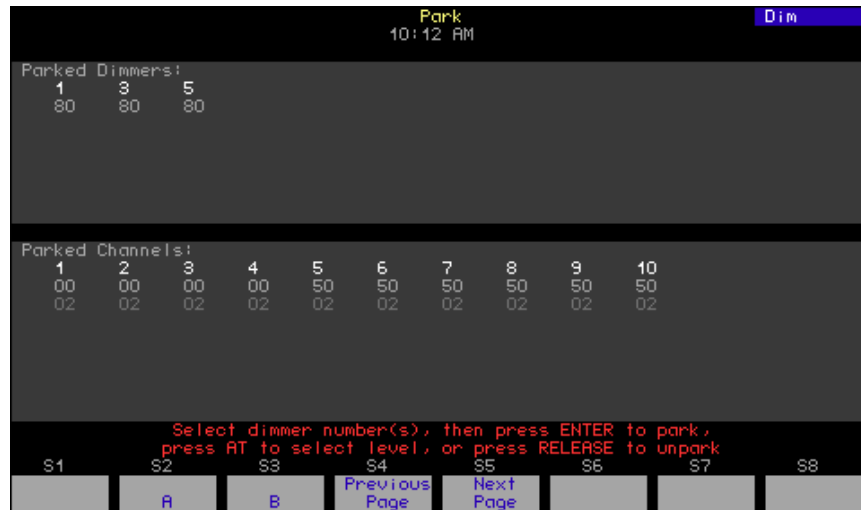

## Parking dimmers

Park a dimmer by specifying the dimmer number and level. You may park multiple dimmers at once. When dimmers are parked, the message **Park Enabled** appears near the top of the Stage display.

Park one or more dimmers as follows:

Keystrokes:	Action:
1. Press [Stage].	Selects Stage display
2. Press [S6], <b>Park</b> , [Dim].	Prompt reads: <b>Select dimmer number(s), then press ENTER to park, press AT to select level, or press RELEASE to unpark</b>
3. Enter the dimmer number(s) to park, then press [At]. <sup>a</sup>	Selects the dimmer to park Prompt reads: <b>Enter intensity for park dimmer(s)</b>
4. Enter the level at which to park the dimmer.	Parks the dimmer at the selected level Alert appears: <b>Parked Dimmers</b>

<sup>a</sup> In all references in this chapter to the use of [At] to set a level, you may substitute the [Full] or [Level] keys.

## ***Unparking dimmers***

### ***Unparking one dimmer***

Unpark one dimmer at a time as follows:

<b>Keystrokes:</b>	<b>Action:</b>
1. Press [Stage].	Selects Stage display
2. Press [S6], <b>Park</b> , [Dim].	Prompt reads: <b>Select dimmer number(s), then press ENTER to park, press AT to select level, or press RELEASE to unpark</b>
3. Enter the dimmer number to unpark and press [Rel].	Unparks the dimmer

### ***Unparking all dimmers***

Unpark all dimmers at once as follows:

<b>Keystrokes:</b>	<b>Action:</b>
1. Press [Stage].	Selects Stage display
2. Press [S6], <b>Park</b> , [Dim].	Prompt reads: <b>Select dimmer number(s), then press ENTER to park, press AT to select level, or press RELEASE to unpark</b>
3. Press [Rel].	Prompt reads: <b>To release all parked dimmers, press ENTER.</b> <b>To cancel, press CLEAR</b>
4. Press [Enter].	Unparks all parked dimmers

## Parking channels

Park a channel by specifying the channel number and level. You may park multiple channels at once. Set the level using the keyboard or with reference to a preset focus point. When channels are parked, a yellow alert appears near the top of the command display that reads **Park Enabled**.

### Using the keyboard

Park one or more channels at levels taken from the keyboard as follows.

<b>Keystrokes:</b>	<b>Action:</b>
1. Press [Stage].	Selects Stage display
2. Press [S6], <b>Park</b> .	Prompt reads: <b>Select channel number(s), then press ENTER to park, press AT to select level, or press RELEASE to unpark</b>
3. Press [1] [Thru] [1][0] [Full].	Parks the channel at Full. Alert appears: <b>Parked Channels</b>

### Parking at a focus point

You can park channels at a focus point as well as park focus point channels themselves. See [Parking recorded channels, page 194](#), for information about parking focus point channels.

When you park channels at a focus point, they are linked to the focus point and take whatever levels are set for the channels in the focus point. If those levels in the focus point change, the link causes the same change to occur for the parked channels. Channels parked at a focus point are shown in the Park display with both the channel's current level in the focus point and the focus point number.

Park channels at a focus point using the following procedure.

<b>Keystrokes:</b>	<b>Action:</b>
1. Press [Stage].	Selects Stage display
2. Press [S6], <b>Park</b> .	Prompt reads: <b>Select channel number(s), then press ENTER to park, press AT to select level, or press RELEASE to unpark</b>
3. Press [Chan] [1] [Thru] [1][0] [Focus Point] [6].	Prompt reads: <b>Select focus point and press ENTER</b>
4. Press [Enter].	Parks the channel at focus point 6 Alert appears: <b>Parked Channels</b>

## ***Unparking channels***

### ***Unparking one channel***

Unpark one channel at a time as follows:

**Keystrokes:**

1. Press [Stage].
2. Press [S6], **Park**.
3. Enter the channel number to unpark and press [Rel].

**Action:**

Selects Stage display

Prompt reads:

**Select channel number(s), then press ENTER to park, press AT to select level, or press RELEASE to unpark**

Unparks the channel

### ***Unparking all channels***

Unpark all channels at once as follows:

**Keystrokes:**

1. Press [Stage].
2. Press [S6], **Park**.
3. Press [Rel].
4. Press [Enter].

**Action:**

Selects Stage display

Prompt reads:

**Select channel number(s), then press ENTER to park, press AT to select level, or press RELEASE to unpark**

Prompt reads:

**To release all parked channels, press ENTER. To cancel, press CLEAR**

Unparks all parked channels

## ***Parking recorded channels***

Cues, submasters, groups and focus points may all be parked, either at the levels recorded for their channels or at a proportional level.<sup>16</sup> For example, if all your worklights are recorded in a group, you could park that group at once, rather than park the worklight channels individually.

Following is an example of how to park a group's channels. Use the same procedure to park the channels of a cue, submaster or focus point except press the [Cue], [Sub] or [Focus Point] key in place of the [Group] key in step 2 of this procedure.

<b>Keystrokes:</b>	<b>Action:</b>
1. Press [Stage].	Selects Live display
2. Press [S6], <b>Park</b> , [Group].	Prompt reads: <b>Group mode - Select group number, then press AT to park, or press Release to unpark</b>
3. Enter the group number and press [At].	Selects the group to park Prompt reads: <b>Group mode - Enter intensity</b>
4. Enter the level at which to park the group's channel.	Parks the channels at the selected level

## ***Unparking recorded channels***

You can unpark all channels that are recorded into a cue, submaster, group or focus point.

Follow the procedure below to unpark the channels in a cue. To unpark channels in a submaster, group or focus point, press the [Sub], [Group] or [Focus Point] key in place of the [Cue] key in step 2 of this procedure.

<b>Keystrokes:</b>	<b>Action:</b>
1. Press [Stage].	Selects Stage display
2. Press [S6], <b>Park</b> , [Cue].	Prompt reads: <b>Group mode - Select cue number to use as group, then press AT to park, or press Release to unpark</b>
3. Press [5] [Rel].	Unparks cue five's channels

---

<sup>16.</sup> *Parking focus point channels only takes the current levels in the focus point. It does not create a link to the focus point.*

## Parking fixtures

You can park fixtures, one at a time or in ranges, either at levels set from the keypad or at a focus point. When you park a fixture, all channels patched to the fixture are parked whether you select them to set levels or not.

### ***After setting attribute levels from the keypad***

Follow the procedure below to park fixtures with their intensity and position attributes set from the keypad.

<b>Keystrokes:</b>	<b>Action:</b>
1. Press [Stage].	Selects Live display
2. [S8], <b>Fixture</b> , [1] [Thru] [3].	The fixture box appears and is set to fixture 3
3. Press [Full].	Sets fixture intensities to full
4. Set pan and tilt with encoders or your mouse.	Sets position attribute levels
5. Press [S6], <b>Park</b> .	Prompt reads: <b>Press ENTER to park channel(s), press AT to select level, or press RELEASE to unpark channel(s)</b>
6. Press [Enter].	Parks the fixture

### ***After setting attribute levels at a focus point***

You can park a fixture that has attributes set at a focus point. If you do not select fixture attributes, all attributes are parked at the focus point. If you select attributes before parking, those selected are parked at the focus point, and the remaining attributes are parked at their existing levels.<sup>17</sup>

Follow the procedure below to park all attributes of a fixture at a focus point.

<b>Keystrokes:</b>	<b>Action:</b>
1. Press [Stage].	Selects Live display
2. [S8], <b>Fixture</b> , [1].	The fixture box appears and is set to fixture 1
3. Press [Focus Point] [5].	Sets all attributes at focus point 5
4. Press [S6], <b>Park</b> .	Prompt reads: <b>Press ENTER to park channel(s), press AT to select level, or press RELEASE to unpark channel(s)</b>
5. Press [Enter].	Parks the fixture

---

<sup>17</sup>. See [The Only command, page 8](#), to select fixture attributes.

## ***Unparking fixtures***

When you unpark a fixture, all channels patched to that fixture are unparked. After unparking a fixture, its attribute levels revert to the levels the console assigns to them.

### **Keystrokes:**

1. Press [Stage].
2. [S8], **Fixture**, 1.
3. Press [Park].
4. Press [Rel].

### **Action:**

Selects Live display

The fixture box appears and is set to fixture 1

Prompt reads:

**Press ENTER to park channel(s),  
press AT to select level, or press  
RELEASE to unpark channel(s)**

The fixture is unparked

Prompt reads:

**Select channel numbers**



# ***Chapter 16***

## ***Effects***

An effect is a cue or a submaster that can run in a variety of patterns called chases. Each effect step contains channels. When the step runs, channel level is controlled when the channel is specifically addressed.

An effect can be positive, with lights starting off and being turned on in patterns, or negative, with lights starting on and being turned off in patterns. It can have up to 100 steps, each of which can last up to 99:59 minutes. The effect may be created in Blind or while viewing the steps in Stage. Steps in the effect are individually controlled for level and timing, and the effect is subject to a separate, overall timing parameter.

This chapter includes the following sections:

- The Blind Effects display
- Creating an effect in Blind
- Creating an effect in Stage
- Modifying the effect
- Modifying step timing and levels
- Effect fade times
- Setting a random effect rate
- Running an effect cue
- Using an effect submaster

## Blind Effects display

Effects may be created or edited in the Blind Effects display. You enter the Blind Effects display from Blind as soon as you specify the effect type for a new cue or submaster. You also enter the Blind Effect display as soon as you specify a cue or submaster that already exists as an effect. An illustration of the Blind Effects display for a cue is shown below.

The screenshot shows the 'Blind' interface with the following data:

Step	Channel	Time	In	Dwell	Out	Lo	Hi
1	1 2 3 4 5 6 7 8 9 ...	0.2	5	1	5	0	FL
	FL FL FL FL FL FL FL FL FL						
	01 01 01 01 01 01 01 01 01						
2	8 18 28 38 48 68	0.2	5	1	5	0	FL
	90 90 90 90 90 90						
3	5 6 7 8 9	0.2	5	1	5	0	FL
	50 50 50 50 50						

Attributes: Positive Random rates: 100 / 100

Select step number(s)  
(To clear step(s), select step number(s), then press CLEAR)

Not Recorded

Cue/Type	Up	Dwell	Down	Link	Follow	Rate	Label
1 EF	0	Hold	0			200	

Cues left: 597

S1 Step S2 Cue List S3 Spread Sheet S4 Previous Page S5 Next Page S6 Delete Cue S7 More Softkeys S8 Add Channels

## Features

The following information is contained in the Blind Effects display.

- **Attributes** - There are seven attributes of an effect which control how it plays its steps.<sup>18</sup>
- **Random rates** - When an effect has random rates, its steps run at randomly selected step times and step fade times. The randomness varies between two, editable limits that are shown in the display.
- **Step** - Each effect is composed of steps. There can be up to 100 steps in an effect and each step contains one or more individual channels. The number of channels in an effect step is limited only by the number of channels available to the console.
- **Channel** - This field in the effect display shows the channels in each step.
- **Time** - The Step Time, which is measured from the beginning of a step to the beginning of the next step. Default Step Time is 0.2 seconds.
- **In** - The In Time, the meaning of which depends upon whether the effect has a positive or negative attribute. For a positive effect, the In Time is the time the effect step takes to fade from its starting level to its High Level. For a negative effect, the In Time is the time the effect step takes to fade from its starting level to its Low Level. Default In Time is zero seconds.
- **Dwell** - The time between the end of the infade and the start of the outfade is called the dwell. Default Dwell time is zero seconds.<sup>19</sup>

<sup>18</sup>. See [Modifying effect attributes, page 212](#).

- **Out** - The Out Time, the meaning of which depends upon whether the effect has a positive or negative attribute. For a positive effect, the Out Time is the time the effect step takes to fade from its High Level to its Low Level. For a negative effect, the Out Time is the time the effect step takes to fade from its Low Level to its High Level. Default Out Time is zero seconds.
- **Lo** - Known as Low Level, this is the lowest level the effect is allowed to reach. The default Low Level is zero.
- **Hi** - Known as High Level, this is the highest level the effect is allowed to reach. The default High Level is Full.

## Effects in Stage

You can also create effects in the normal Stage display, where you can see effect steps as you create them. The only difference between effects and other types of cues in this display lies in the information provided in the Attribute Bar.

Below is an illustration of the Stage display for an effect cue. The illustration shows the softkeys presented and information contained in the Attribute Bar when step 7 of this cue is identified.



---

19. For the default condition of 0/0/0 for In/Dwell/Out, however, the step has an instantaneous In fade, remains there for the entire Step Time and then has an instantaneous Out fade.

## Creating an effect in Blind

The first step in creating an effect is the same for Stage or Blind. Following is the procedure for creating the effect in Blind.

### Keystrokes:

1. Press [Blind] [1] [Type].
2. Press [3].

### Actions:

The blind display defaults to cue selection and you specify cue 1



Prompt reads:

**Select fade type (1=Crossfade, 2=Allfade, 3=Effect, 4=Subroutine, 5=Blocking)**

Specifies an effect type. You are presented with the Blind Effects display. Prompt reads:

**Select step number(s)  
(To clear step(s), select step number(s), then press CLEAR)**

Following is a table illustrating how to navigate in the Blind Effects display and the resulting feedback.

Navigation and Feedback - Blind Effects Display					
		[S]			$\pm$
Select a step	X	X	X		X
Select a field		X		X	
White row	selected step				
Yellow field <sup>a</sup>	selected field				

<sup>a</sup>. If the channel field is selected, all channels are highlighted white except for a selected channel, which is colored yellow.

Once you have specified an effect type, you may proceed to specify steps, either one at a time or in ranges, and add channels to them. Specify steps by identifying the next one in sequence or by moving through steps with the up/down arrow keys.

Only steps that contain channels will be active in the effect. Add channels to an effect step in any of the following ways:

- directly, either individually or in a range
- in groups, focus points or channels linked to a focus point<sup>20</sup>
- in grouped cues or submasters

<sup>20</sup>. Channels added in a focus point or linked to a focus point automatically change in the step whenever they change in the focus point.

## Notes on working with steps in Blind

- Steps may be specified one at a time or in ranges.<sup>21</sup>
- Channels at Full in the Blind Effects display do not show the level (except when set at a focus point).
- If you add a channel more than once to a step, it takes the last level assigned.

## Adding channels directly

The procedure for creating steps by adding channels to them in the Blind Effects display is shown below.

### Keystrokes:

1. Press [S1], **Step**, and enter the step number. A new step must always have the next highest number, beginning with step 1.
2. Press [Chan] [1] [Thru] [5].
3. Press [S8], **Add Channels**, [At] [5][0].
4. Press [Record] [Enter].

### Actions:

- Specifies next step to be created.  
Prompt reads:  
**Select step number(s)  
(To clear step(s), select step number(s), then press CLEAR)**
- Specifies channels to be added.  
Prompt reads:  
**Select channel number(s) and press ADD CHANNELS to add to step(s), or press AT to edit existing channel levels**
- Adds channels to step at level 50.  
Prompt reads:  
**Select channel number(s) and press ADD CHANNELS to add to step(s), or press AT to edit existing channel levels**
- Records the channels to the effect step. Prompt reads:  
**Select cue number  
To write effect, press STEP**

---

<sup>21</sup>. Channels, groups, focus points, or grouped channels may be added one at a time or in multiples. If added in multiples and the number to be added exceeds the number of steps specified, they are assigned on a one-to-one basis in a rotating order to all specified steps. For example, adding channels 1 through 10 to steps 1 through 4 results in the following assignment:

<u>Channels</u>	
Step 1	1, 5, 9
Step 2	2, 6, 10
Step 3	3, 7
Step 4	4, 8

## ***Adding groups or focus points***

The procedure for creating steps by adding groups or focus points to them in the Blind Effects display is shown below. All channels in a group or focus point are added to the step(s) together but they may be edited individually later.

### **Keystrokes:**

1. Press [S1], **Step**, and enter the step number. A new step must always have the next highest number, beginning with step 1.
2. Press [Group] [5] [Thru] [1][0].<sup>a</sup>
3. Press [S8], **Add Channels**.
4. Press [Record] [Enter].

### **Actions:**

- Specifies next step to be created.  
Prompt reads:  
**Select step number(s)  
(To clear step(s), select step number(s), then press CLEAR)**
- Selects groups 5 through 10.  
Prompt reads:  
**Group mode - Select group(s) and press ADD CHANNELS to add to step(s), or press AT to edit existing channel level(s)**
- Adds groups' channels to step.  
Prompt reads:  
**Group mode - Select group(s) and press ADD CHANNELS to add to step(s), or press AT to edit existing channel level(s)**
- Records the channels to the effect step. Prompt reads:  
**Select cue number  
To write effect, press STEP**

<sup>a</sup> To add focus points rather than groups, press [Focus Point] rather than [Group] in this step.

## ***Adding grouped channels***

The procedure for creating steps in the Blind Effects display by adding grouped channels from cues or submasters to them is shown below. All channels in a group or focus point are added to the step(s) together but they may be edited individually later.

### **Keystrokes:**

1. Press [S1], **Step**, and enter the step number. A new step must always have the next highest number, beginning with step 1.
2. Press [Group] [Cue] [5] [Thru] [1][0].<sup>a</sup>
3. Press [S8], **Add Channels**, [At] [5][0].
4. Press [Record] [Enter].

### **Actions:**

- Specifies next step to be created.  
Prompt reads:  
**Select step number(s)  
(To clear step(s), select step number(s), then press CLEAR)**
- Selects the channels of cues 5 through 10. Prompt reads:  
**Group mode - Select focus point(s) and press ADD CHANNELS to add to step(s), or press AT to edit existing channel level(s)**
- Adds channels to step at level 50  
Prompt reads:  
**Group mode - Select focus point(s) and press ADD CHANNELS to add to step(s), or press AT to edit existing channel level(s)**
- Records the channels to the effect step. Prompt reads:  
**Select cue number  
To write effect, press STEP**

<sup>a</sup> *To add grouped submasters rather than grouped cues, press [Submaster] rather than [Cue] in this step.*

## Creating an effect in Stage

Build an effect in Stage while viewing the results with captured channels. You can work with individual channels or with channels in cues, groups or focus points. Channels may be added to steps in any of the following ways:

- directly, either individually or in a range
- in groups or focus points
- linked to a focus point<sup>22</sup>
- in grouped cues or submasters

### Notes on working with steps in Stage

- You may only add channels to one step at a time.
- Steps may be specified in any order but always default to the next highest one in order. To specify a step number, Press [S7], **More Softkeys**, until [S8] reads **Step**. Then press [S8] and enter the step number
- If a channel is added to a step more than once, its level will be the last one assigned.

### Adding channels directly

The procedure for creating an effect in Stage and adding channels to its steps is shown below.

#### Keystrokes:

1. Press [Stage] [Cue] [5].
2. Press [Type] [3].
3. Press [1] [Thru] [9] [Full].
4. Press [Record] [Enter].<sup>a</sup>
5. Repeat steps 3-4 to create other steps.<sup>b</sup>

#### Actions:

- Specifies cue 5  
Prompt reads:  
**Select cue number**  
**To select cue type, press TYPE**
- Defines the cue as an effect type  
Prompt reads:  
**Select channel numbers**
- Selects channels to add and assigns them a level  
Prompt reads:  
**Select channel numbers**
- Records the step and advances the step indicator to the next in sequence  
Prompt reads:  
**Select channel numbers**

<sup>a</sup> Specify the step number after [Record] if you do not want to create the next step in order. See [Notes on working with steps in Stage, page 204](#).

<sup>b</sup> You may also use either of the other two methods discussed in this section to create additional steps.

---

<sup>22</sup> The level of a channel linked to a focus point automatically changes in the step if the level changes in the focus point.



## Adding groups or focus points

The procedure for creating an effect in Stage and adding one or more recorded groups or focus points to its steps is shown below.<sup>23</sup>

### Keystrokes:

1. Press [Stage] [Cue] [6].
2. Press [Type] [3].
3. Press [Group] [5] [And] [8] [Full].<sup>a</sup>
4. Press [Record] [Enter].<sup>b</sup>
5. Repeat steps 3-4 to create other steps.<sup>c</sup>

### Actions:

- Specifies cue 6  
Prompt reads:  
**Select cue number**  
**To select cue type, press TYPE**
- Defines the cue as an effect type  
Prompt reads:  
**Select channel numbers**
- Captures groups 5 and 8 at full on stage  
Prompt reads:  
**Group mode - Press AT or use wheel or trackpad to alter levels, or select channels numbers to edit**
- Records the step and advances the step indicator to the next in sequence  
Prompt reads:  
**Select channel numbers**

<sup>a</sup> Substitute [Focus Point] for [Group] to add one or more focus points.

<sup>b</sup> Specify the step number after [Record] if you do not want to create the next step in order. See [Notes on working with steps in Stage, page 204](#).

<sup>c</sup> You may also use either of the other two methods discussed in this section to create additional steps.

---

<sup>23</sup> Channels added in Stage in focus points do not update in the effect whenever the focus point changes.

## ***Adding grouped channels***

The procedure for creating steps in the Stage by adding channels grouped from cues or submasters is shown below.

### **Keystrokes:**

1. Press [Stage] [Cue] [7].

2. Press [Type] [3].

3. Press [Group] [Cue] [1]  
[And] [2] [Full].<sup>a</sup>

4. Press [Record] [Enter].<sup>b</sup>

5. Repeat steps 3-4 to create other steps.<sup>c</sup>

### **Actions:**

Specifies cue 7

Prompt reads:

**Select cue number**

**To select cue type, press TYPE**

Defines the cue as an effect type

Prompt reads:

**Select channel numbers**

Captures the channels of cues 1 and 2, setting all to full

Prompt reads:

**Group mode - Press AT or use wheel or trackpad to alter levels, or select channels numbers to edit**

Records the step and advances the step indicator to the next in sequence channels to the effect step

Prompt reads:

**Select channel numbers**

<sup>a</sup> To add grouped submasters rather than grouped cues, press [Submaster] rather than [Cue] in this step.

<sup>b</sup> Specify the step number after [Record] if you do not want to create the next step in order. See [Notes on working with steps in Stage, page 204](#).

<sup>c</sup> You may also use either of the other two methods discussed in this section to create additional steps.

## Modifying the effect

You can set channel levels or add channels to steps with Update in Stage. In Blind, however, you can do these and many more editing functions, such as deleting channels from steps, inserting or deleting steps and modifying the attributes of the effect. The first procedure, below, applies to Stage, and all the rest in this section apply only to Blind.

### Using Update

With Update, you can do live editing of effect steps in Stage and see the results immediately on stage. Use the procedure below to add channels and set levels for effect cue 100, assumed to have been previously created.

#### Keystrokes:

1. Press [Stage] [Cue] [1][0][0].
2. Press [S8], **Fixture**, [4] [Thru] [6] [Full].
3. Set the pan and tilt levels. <sup>a</sup>
4. Press [S2], **Update**.
5. Press [S7], **More Softkeys**, until you see **Step** at softkey [S8].
6. Press [S8], **Step**, [1].
7. Press [Only] [S8], **Fixture**, [5].<sup>b</sup>
8. Press [Enter].
9. Press [Rel][Rel].
10. Repeat steps 2 through 8.

#### Action:

- Selects effect cue 100 in Stage
- Selects fixture 4 and 6 and sets their intensity levels to full
- Sets the levels of the position attributes of all selected fixtures
- Prompt reads:  
**To update cue, select number and press ENTER**  
**To update step, press STEP**
- Selects step 1  
Prompt reads:  
**Select step number**
- Restricts the update to fixture 5  
Prompt reads:  
**Select fixture number(s)**  
**To cancel, press CLEAR**
- Updates step 1 of cue 100
- Clears captured channels
- Update other steps in the same cue

<sup>a</sup> Use your trackpad.

<sup>b</sup> Optional step. If not restricted with Only, all captured and selected channels are included in the update. For more information on the uses of Only, see [The Only command, page 8](#).

## ***Editing channel levels***

Regardless how channels were added to the effect, channels may be individually edited in the effect, either individually or in ranges. Levels may be set with the keypad or with reference to focus points.

Follow the procedure below to edit channel levels in a recorded effect cue that has at least 5 steps. Levels are set with reference to a focus point.

<b>Keystrokes:</b>	<b>Actions:</b>
1. Press [Blind] [Cue] [1].	Go to the Blind Effects display Prompt reads: <b>Select cue number</b> <b>To write effect, press STEP</b>
2. Press [S1], <b>Step</b> , [5].	Specifies step 5 <b>Select step number(s)</b> <b>(To clear step(s), select step number(s), then press CLEAR)</b>
3. Press [Chan] [5] [And] [8].	Selects channels 5 and 8 Prompt reads: <b>Select channel number(s) and press</b> <b>ADD CHANNELS to add to step(s),</b> <b>or press AT to edit existing channel level(s)</b>
4. Press [At] [Focus Point] [1] [Enter].	Sets levels of channels 5 and 8 to their levels in focus point 1
5. Repeat steps 2-4 to set levels in other steps. Alternatively, use the up/down arrow keys to move to other steps for editing.	Continue to edit channels
6. Press [Record] [Enter].	Records your changes to the cue

## ***Adding channels***

Add additional channels to an effect step using any of the procedures used to add channels when the step was created. See [Creating an effect in Blind, page 200](#).

## ***Deleting channels***

Delete channels from a previously created effect step with the following procedure.

### **Keystrokes:**

1. Press [Blind] [Cue] [1].
2. Press [S1], **Step**, [5].
3. Press [Chan] [5] [And] [8].
4. Press [Clear].
5. Press [Record] [Enter].

### **Actions:**

Go to the Blind Effects display  
Prompt reads:

**Select cue number**

**To write effect, press STEP**

Specifies step 5

**Select step number(s)**

**(To clear step(s), select step number(s), then press CLEAR)**

Selects channels 5 and 8

Prompt reads:

**Select channel number(s) and press  
ADD CHANNELS to add to step(s),  
or press AT to edit existing channel  
level(s)**

Deletes channels

Records your changes to the cue

## Inserting steps

You may insert a new step in place of an existing one in an effect. The inserted step takes the place of the selected step and other steps are renumbered. For instance, if inserting a step at number 5, the existing step 5 becomes step 6; step 6 becomes step 7, and so on. The timing and level settings from step 4 are set as initial settings in the new step 5.

For example, to insert a step between steps 4 and 5, follow these steps:

- | <b>Keystrokes:</b>  | <b>Action:</b>   |
|---|--|
| 1. Press [Blind] [Cue] [2].   | Selects cue 2  |
| 2. Press [S7], <b>More Softkeys</b> .   |  |
| 3. Press [S5], <b>Insert Step</b> .   | Prompt reads:<br><b>Select step number to insert, then press ENTER</b><br><b>To cancel, press CLEAR</b>                                  |
| 4. Use the [↑] and [↓] keys to highlight the step you wish to insert or...<br>Enter the number of the step. | Prompt reads:<br><b>Select step number to insert, then press ENTER</b><br><b>To cancel, press CLEAR</b>                                  |
| 5. Press [Enter].   | Prompt reads:<br><b>Select channel number(s) and press ADD CHANNELS to add to step(s), or press AT to edit existing channel level(s)</b> |
| 6. Add channels using one of the techniques available.  |  |
| 7. Press [Record] [Enter].  | Records your changes to the cue  |

## ***Deleting steps***

You may delete any step from an effect, which causes other steps to be renumbered. For instance, if deleting step 5, step 6 becomes step 5; step 7 becomes step 6, and so on.

For example, to delete step 5, follow these steps.:

<b>Keystrokes:</b>	<b>Action:</b>
1. Press [Blind] [Cue] [2].	Selects cue 2
2. Press [S7], <b>More Softkeys.</b>	
3. Press [S6], <b>Delete Step.</b>	Prompt reads: <b>Select step number to delete, then press ENTER</b> <b>To cancel, press CLEAR</b>
4. Use the [↑] and [↓] keys to highlight step 5.	Selects step 5
5. Press [Enter].	Deletes step 5 Prompt reads: <b>Select step numbers</b>
6. Press [Record] [Enter].	Records your changes to the cue

## ***Modifying effect attributes***

Attributes control how the effect plays its steps. Set effect attributes by pressing [S7], **More Softkeys**, [S8], **Attribute**. Except for setting a random rate, make one or more softkey selections. Each softkey toggles the effect attribute, so pressing it can either add or remove the selection.

Effect attributes are defined as follows:

- **Positive/Negative** - Softkey [S1] toggles between the positive and negative attributes. Steps in a positive effect set their channels to their High Level and set the channels of the previous step to their Low Level. Steps in a negative effect set their channels to their Low Level and set the channels of the previous step to their High Level.
- **Alternate** - Sets the effect to alternate between positive and negative chases through its steps. The first pass is positive if the effect is positive, negative if the effect is negative.
- **Reverse** - Effect steps run in reverse numerical order.
- **Bounce** - Steps run first in forward, then in reverse order. Subsequent passes alternate between forward and reverse.
- **Build** - All channels are set to their Low Level at the beginning of the chase. Each step turns its channels to their High Level and leaves the previous step at the High Level. At the end of the chase, all channels are at the High Level. They are all set at their Low Levels to start the next pass. In a negative effect, all steps are at their High Levels at the beginning of the chase. Each step turns its channels to the Low Level and leaves previous channels at the Low Level. At the end of the chase, all channels are at the Low Level. They are all set at their High Levels to start the next pass.
- **Random** - A Random effect plays steps back in random order. An effect with a random rate runs at varying speeds, changing at random, within a range that you select. The console applies a random rate to the assigned step time and to the step fade times. Random is ideal for creating lightning and fire effects.

The rules for assigning effect attributes are as follows.

- All effects are either Positive or Negative. An effect is initially positive when it is created.
- Alternate, Reverse, Bounce, and Build can be applied in any combination to a Positive or a Negative effect.
- Random can be applied to any Positive or Negative effect. Random may not be combined with Alternate, Reverse, Bounce, or Build.



## Modifying step timing and levels

Once all steps are defined for an effect, you can either accept the defaults or you can change one or more settings in a single operation. The step defaults are as follows:

- Step Time 0.2 seconds
- In Time 0 seconds
- Dwell Time 0 seconds
- Out Time 0 seconds
- Low Level Zero
- High Level Full

Set step timing and levels of a recorded effect with the following procedure.<sup>24</sup>

### Keystrokes:

1. Press [Blind] [Cue] [1].
2. Press [S1], **Step**, [5].
3. Press [S7], **More Softkeys**, [S2], **Step Time**.
4. Press [1][0] [Enter].
5. Press [2] [Enter].
6. Press [6] [Enter].

### Actions:

- Go to the effects display for a previously recorded effect cue  
Prompt reads:  
**Select cue number**  
**To write effect, press STEP**
- Specifies step 5  
Prompt reads:  
**Select step number(s)**  
**(To clear step(s), select step number(s), then press CLEAR)**
- Selects step time field  
Prompt reads:  
**Select step time**
- Sets step time to 10 seconds and advances to the next field  
Prompt reads:  
**Select step in time**
- Sets step in time to 2 seconds and advances to the next field  
Prompt reads:  
**Select step dwell time**
- Sets dwell time to 6 seconds and advances to the next field  
Prompt reads:  
**Select step out time**

---

<sup>24</sup>. Press [→] or [Enter] without a number to skip any selection.

- |  |   |
|--|---|
| 7. Press [2] [Enter].                            | Sets step out time to 2 seconds and advances to the next field<br>Prompt reads:<br><b>Select low level</b>  |
| 8. Press [1][0]. <sup>a</sup>                    | Sets low level to 10 and advances to the next field<br>Prompt reads:<br><b>Select high level</b>  |
| 9. Press [9][0]. <sup>b</sup>                    | Sets high level to 90 and advances to the next field<br>Prompt reads:<br><b>Select step number(s)<br/>(To clear step(s), select step number(s), then press CLEAR)</b> |
| 10. Press [↑] or [↓] and repeat steps 3-9 above. | Make changes to another step  |
| 11. Press [Record] [Enter],                      | Records your changes to the cue   |

- <sup>a</sup>. A one-digit entry must be followed by [Enter] and is interpreted as the digit times 10.
- <sup>b</sup>. A one-digit entry must be followed by [Enter] and is interpreted as the digit times 10.

## Effect fade times

Each effect has an overall upfade, dwell and downfade time. When you create an effect cue, the times default to the cue fade times in your system settings. If you have not changed the default settings, this means an upfade of zero seconds, a dwell of **hold**,<sup>25</sup> and a downfade<sup>26</sup> of zero seconds. Press [Time] to set the effect's upfade, dwell and downfade times.

Fade times may be programmed from 0.1 seconds to 99:59 minutes. The number may be entered in normal time format or in decimal format. When entered with a decimal point, the number must be less than one minute (0.1 to 59.9 seconds) to be accepted. When entered without a decimal point, a 2-digit number will be treated as seconds if less than 60 and as a calculated value of minutes and seconds if between 60 and 99. For example, if you enter 70, the time will display as 1:10. If you enter either a 3-digit or a 4-digit number, the last two digits, up to 59, are interpreted as seconds. For example, if you enter 9930, the time will display as 99:30.

---

<sup>25</sup>. Dwell time is the length of time the effect runs between the upfade of the first step and the downfade of the last step. **Hold** assigns an infinite dwell time, meaning the effect runs until an associated [Clear], [Go] or bump button is pressed to start the downfade.

<sup>26</sup>. See [Setting default fade times, page 24](#).

## ***Changing upfade, dwell and downfade***

Follow these steps to change the effect's fade times:

<b>Keystrokes:</b>	<b>Action:</b>
1. Press [Blind] [Cue] [2].	Selects cue 2 in the Blind display
2. Press [Time] and enter the upfade time.	Prompt reads: <b>Enter effect upfade time</b>
3. Press [Time] and enter the dwell time.	Prompt reads: <b>Enter effect dwell time</b>
4. Press [Time] and enter the downfade time. Press [Clear] for hold dwell.	Prompt reads: <b>Enter effect downfade time</b>
5. Press [Enter].	Fade time entry is complete Prompt reads: <b>Select step numbers</b>

## ***Changing upfade only***

Follow these steps to change only the effect's upfade time:

<b>Keystrokes:</b>	<b>Action:</b>
1. Press [Blind] [Cue] [2].	Selects cue 2 in the Blind display
2. Press [Time].	Prompt reads: <b>Enter effect upfade time</b>
3. Enter the upfade time.	Prompt reads: <b>Enter effect upfade time</b>
4. Press [Enter] [Enter] [Enter].	Prompt reads: <b>Select step numbers</b>

## ***Changing downfade only***

Follow these steps to change only the effect's downfade time:

<b>Keystrokes:</b>	<b>Action:</b>
1. Press [Blind] [Cue] [2].	Selects cue 2 in the Blind display
2. Press [Time] [Time] [Time].	Prompt reads: <b>Enter effect downfade time</b>
3. Enter the downfade time.	Prompt reads: <b>Enter effect downfade time</b>
4. Press [Enter].	Prompt reads: <b>Select step numbers</b>

## ***Changing dwell only***

Follow these steps to change only the effect's dwell time:

### **Keystrokes:**

1. Press [Blind] [Cue] [2].
2. Press [Time] [Time].
3. Enter the dwell time.
4. Press [Enter] [Enter].

### **Action:**

Selects cue 2 in the Blind display

Prompt reads:

**Enter effect dwell time**

Prompt reads:

**Enter effect dwell time**

Prompt reads:

**Select step numbers**

## ***Resetting hold dwell time***

If the dwell time is set to **Hold**, an effect submaster will continue to run until you press the bump button. An effect cue will continue to run until you press either [Go] or [Hold] [Hold]. To reset the dwell time to **Hold** follow these steps:

### **Keystrokes:**

1. Press [Blind] [Cue] [2].
2. Press [Time] [Time].
3. Press [Clear].
4. Press [Enter] [Enter].

### **Action:**

Selects cue 2 in the Blind display

Prompt reads:

**Enter effect dwell time  
(Press CLEAR for hold)**

Hold appears in the Dwell box of the cue attribute line

Dwell time set to **Hold**

Prompt reads:

**Select step numbers**

## Setting a random effect rate

An effect runs at a rate set by the submaster or cue in which the effect is recorded.<sup>27</sup> It can also run at a random rate within minimum and maximum parameters. Set the minimum and maximum parameters with the following procedure to control the range of randomness of the effect.

Keystroke:	Action:
1. Press [Blind] [Cue] [2].	Selects cue 2 in the Blind display
2. Press [S7], <b>More Softkeys</b> , [S8], <b>Attribute</b> .	Displays available attributes across the bottom of the screen
3. Press [S7], <b>Random Rate</b> .	Prompt reads: <b>Select low random rate (0 to 2000, 100=Normal)</b>
4. Press [5][0] [Enter].	Specifies the slowest effect rate Prompt reads: <b>Select high random rate (0 to 2000, 100=Normal)</b>
5. Press [2][0][0][Enter].	Specifies the highest effect rate

## Running an effect cue

Play back effects recorded as cues on the console's A/B or C/D faders, just as you would any other cue. The effect will run, using the cue's Up, Dwell and Down times to determine how long the cue lasts. To run the cue, press [Stage] [Cue], enter the effect cue number, and press [Go].

An effect cue with a **Hold** dwell time runs on the fader until you press that fader's [Clear] key to begin the downfade. Press [Clear] once to fade out an effect cue in the recorded downfade time. Press the fader's [Clear] key twice to cancel an effect from the fader immediately.

You may use the playback sliders to manually control the cue, allowing you to fade the effect up and down with the playback slider.

## Using an effect submaster

An effect recorded to a submaster interacts with cues and other submasters on a pile-on basis.<sup>28</sup> Bring up the effect by pressing the submaster's bump button or raising the slider.

An effect submaster fades proportionally between zero and the effect's high level. The slider acts as a master. If the effect's low level is normally 10 percent, moving the slider to 50 percent will reduce the effect's low level to 5 percent.

---

<sup>27.</sup> *Adjusting the rate does not affect the overall Up/Dwell/Down times for the cue or submaster. It does, however, speed up or slow down the individual steps. For information about controlling cue or submaster rates, see pages [Rate override, page 126](#) and [Live control of a submaster's rate, page 167](#).*

<sup>28.</sup> *See [Adding a rate to a submaster, page 160](#) for information on changing the rate of a submaster.*



# *Chapter 17*

## *Subroutines*

A subroutine is a cue that controls the playback of a series of recorded cues. Subroutines are similar to linked cues, except that they have more playback options.

You can use subroutines and effects to create similar looks. However, subroutines have some advantages over effects. You can also create nested loops or even use an effect cue as a step in a subroutine.

This chapter contains the following sections:

- Steps
- Cue steps
- Style steps
- Creating a subroutine
- Editing a subroutine
- Deleting a step
- Inserting a step

# Steps

All subroutine steps are either cue steps or style steps. A cue step contains an existing recorded cue, which may be an effect cue. The subroutine lets you change levels and fade rates for the cue step without changing the original cues.

A style step contains an instruction that controls the subroutine's playback pattern. This allows you to run loops, run bounces, pause the subroutine until you press go, or end the subroutine and jump to any other cue. The following display shows a subroutine that runs a series of cues in a loop.

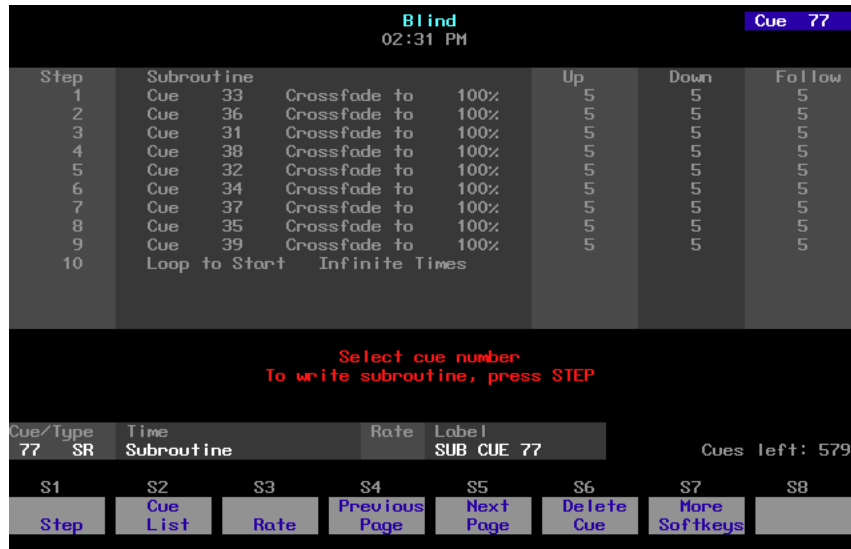

The next two pages describe the types of cue and style steps that are available.

## Cue steps

There are three types of cue steps.

- **Crossfade** A crossfade step is a cue in which all increasing levels fade in the upfade time and all decreasing levels fade in the downfade time.
- **Allfade** An allfade step is a cue in which all channels in both faders fade to a level that you choose and assign to the step.
- **Blocking** A blocking step is a cue that first stops all background cues from running before it runs in a physical fader.



## ***Style steps***

The following playback styles are available for subroutines. A style is assigned to a step. When the subroutine runs, the steps play back in numeric order, until the subroutine reaches a style step. The style step then determines whether the subroutine will loop, bounce, hold, or end and run a different cue.

- **Loop** - The subroutine runs through steps until it reaches a Loop step. It then returns to the first step, and repeats the sequence for the number of times you specify. When you create the Loop step, enter the number of times you want the loop to return to the top of the step list. If you enter **5**, the sequence will play six times. Enter **0** to create a continuous loop.
- **Bounce** - The subroutine runs through steps until it reaches a Bounce step. It then runs back through the steps in reverse order, and repeats the sequence for the number of times you specify. When you create the Bounce step, enter the number of times you want the subroutine to bounce. One bounce equals running through the sequence forward once and reverse once. Enter **0** for a continuous bounce.
- **Jump-to-cue** - The subroutine runs through steps until it reaches a Jump-to-cue step. It then automatically starts another cue which is not included in the subroutine. You can jump to any type of cue: regular, subroutine or effect. When you create the Jump-to-cue step, enter the number of the cue to which to jump.
- **Hold-for-Go** - The subroutine runs through steps until it reaches a Hold-for-Go step. It then pauses until you press [Go].

## ***Subroutine attributes***

The following attributes may be applied to each cue step.

- **Level** - Sets an intensity level for the cue within the subroutine. The level proportionally affects the channel levels assigned to the original cue. Levels must be entered as two-digit numbers (e.g., **20** for 20 percent, **05** for five percent). Use [Full] for 100 percent.
- **Fade times** - Upfade times may range from 0.1 seconds to 99:59 minutes. If you do not enter a time, the downfade will match the upfade.
- **Follow time** - Follow time is the time between the start of one step and the start of the next. Follow times may range from 0.1 seconds to 99:59 minutes.

## Creating subroutines

Create subroutines in the Blind display. A subroutine can have up to 100 steps. Each step lists a cue or a style.

To create a subroutine, follow these steps:



<b>Keystrokes:</b>	<b>Action:</b>
1. Create the cues you want to use in your subroutine.	
2. Press [Blind].	Displays Blind mode screen
3. Press [Cue] [7].	Selects cue 7
4. Press [Type].	Displays fade type menu Prompt reads: <b>Select fade type (1 = Crossfade, 2 = Allfade, 3 = Effect, 4 = Subroutine or 5=Blocking)</b>
5. Press [4], <b>Subroutine</b> .	Select subroutine fade type Prompt reads: <b>Select step number(s), then press ENTER</b>
6. Press [1] [→].	Selects step 1. Prompt reads: <b>Enter cue number to fade, or press STYLE to change step type</b>
7. Press [1] [→].	Selects cue 1 for step 1 Prompt reads: <b>Enter type of cue (1 = Crossfade, 2 = Allfade, 3 = Blocking)</b>
8. Press [1].	Designates cue as a crossfade within the subroutine. Prompt reads: <b>Enter intensity</b>
9. Press [5][5].	Selects a level of 55 percent for the cue within the subroutine Prompt reads: <b>Enter upfade time</b>
10. Press [8] [→].	Sets an upfade time of 8 seconds Prompt reads: <b>Enter downfade time</b>
11. Press [→].	Sets a downfade time of 8 seconds Prompt reads: <b>Enter follow time</b>
12. Press [2][0].	Sets a follow time of 20 seconds. Step 1 is now complete
13. Press [S1], <b>Step</b> , [2] [Enter].	Selects step 2 to edit
14. Repeat steps 7 through 13.	Adds additional steps to the subroutine

- |  |   |
|--|---|
| 15. Press [S1], <b>Step</b> , [6] [Enter].   | Selects step 6 to edit  |
| 16. Press [S8], <b>Style</b> , to select a subroutine style. (You may need to press [S7], <b>More Softkeys</b> , first.) | Prompt reads:<br><b>Select style of subroutine command (1 = Loop, 2 = Bounce, 3 = Jump to cue, 4 = Hold for go)</b>   |
| 17. Press [3] [Enter].   | Selects Jump to cue style for step 6<br>Prompt reads:<br><b>Select cue number</b>   |
| 18. Press [8] [Enter].   | Selects cue 8 for Jump to cue. When subroutine reaches step 6, the subroutine ends and runs cue 8.<br>Prompt reads:<br><b>Enter blocking status for jump to cue (1=Blocking, 2=No blocking)</b> |
| 19. Press 2. <sup>a</sup>  | Specifies that the cue will not cause blocking  |
| 20. Complete entering all cue steps and style steps as described above.  |   |
| 21. Press [Record], enter cue number, and press [Enter] to record subroutine cue.  |   |

<sup>a</sup> *Blocking is the default.*

## Editing a subroutine

To edit a subroutine, select the step you wish to change by pressing [S1], **Step**, and entering the step number. Use [And] and [Thru] to select multiple steps.<sup>29</sup> You can either use softkeys to find your way around the Step Display or navigate with other console controls, as shown in the following table.

Navigation and Feedback - Step Display					
		[S]			$\pm$
Select a step	X	X	X		X
Select a field		X		X	
White row	selected step				
Yellow field	selected field				

The softkeys available in the display are as follows.

[S2], <b>Style</b>	Allows you to select a style from the style menu.
[S3], <b>Select Cue</b>	Allows you to enter a cue number for the selected step.
[S4], <b>Type/Level</b>	Allows you to select a crossfade or an all-fade and to set intensity level.
[S8], <b>Up/Down/Follow</b>	Allows you to set upfade and downfade times and to set follow time.

Once you finish editing the subroutine, press [Record] [Enter] to save your changes.

## Deleting a step

Press [S6], **Delete Step**, and enter the step number. Then press [Enter]. The console deletes the selected step and renumbers the remaining steps.

## Inserting a step

Press [S1], **Step**, and enter the step number where you want to insert the new step. Then press [Enter]. The console inserts a blank step before the selected step.

<sup>29.</sup> If you select a range of steps, only cue steps will be selected. Style steps may only be edited individually and will be left out of selected ranges.

# ***Chapter 18***

## ***Macros***

A macro allows you to record a series of keystrokes and later replay it with one or two keystrokes. This can simplify complex tasks that you perform often. You can record up to 2,000 macros, depending on how large they are.

This chapter includes the following sections:

- Creating macros
- Playing macros
- Modifying macros
- Clearing macros
- Copying macros
- Sample macros

## Creating macros

There are two ways to create a macro. You can create it in Macro Editing mode, entering and editing keystrokes without actually executing the instructions, or you can use the console's macro Learn mode to record a sequence of keystrokes as you perform the operation.

You can include any key or button on the console except [Enter Macro] in a macro.<sup>30</sup> You cannot enter slider settings or wheel movements. Each macro can contain up to 50 keystrokes. You can also link macros.

*Caution: The console does not check the sequence of keystrokes to confirm that it will work. It is possible to create macros that don't work. When you run the macro, you will receive whatever error messages are appropriate.*

To avoid problems, you should plan your macro before you start recording it by determining exactly what keystrokes you want to include. You might want to do this by running through the task and writing down each keystroke.

### Using Learn

The Learn function allows you to create a macro by performing an actual sequence of keystrokes. The console records the keystrokes as you make them. The recorded keystroke sequence can then be played by pressing the appropriate macro key. Once you record a macro in Learn mode you can edit the sequence in Macro Editing mode to adjust its operation. Learn works in any display mode except the Macro Editing display and the Designer's Worksheet Editing display.

To create a sample macro using Learn, follow these steps:

<b>Keystrokes:</b>	<b>Action:</b>
1. Press [Stage].	Selects Live display mode
2. Press [Learn].	Prompt reads: <b>Select macro number to learn, then press ENTER</b> <b>To cancel, press CLEAR</b>
3. Press [7] [Enter].	<b>Learning Macro 7</b> flashes in red in the upper left corner of the monitor Prompt reads: <b>Select operation(s) for this macro – press ENTER MACRO when done (Wheels, trackpad and sliders are not valid entries in macros)</b>
4. Enter [Channel] [1] [Thru] [5] [At] [5] [Enter].	Sets channels 1 through 5 at 50 percent
5. Press [Macro Wait].	Prompt reads: <b>Enter wait time</b> <b>Press ENTER when done</b>

---

<sup>30</sup>. *Macros cannot execute MIDI commands.*

- |   |  |
|---|--|
| 6. Press [5] [Enter].                                   | Inserts a five second wait into the macro<br>Prompt reads:<br><b>Select operation(s) for this macro – press ENTER MACRO when done (Wheels, trackpad and sliders are not valid entries in macros)</b> |
| 7. Enter [Channel] [1] [Thru] [1][0] [Full].            | Sets channels 1 through 10 at Full   |
| 8. Press [Macro Wait].                                  | Prompt reads:<br><b>Enter wait time<br/>Press ENTER when done</b>  |
| 9. Press [5] [Enter].                                   | Inserts a five second wait into the macro<br>Prompt reads:<br><b>Select operation(s) for this macro – press ENTER MACRO when done (Wheels, trackpad and sliders are not valid entries in macros)</b> |
| 10. Enter [Channel] [1] [Thru] [1][0] [At] [0] [Enter]. | Sets channels 1 through 10 at zero   |
| 11. Press [Enter Macro].                                | Concludes macro recording  |
| 12. Press [M*] [7] [Enter].                             | Macro 7 runs. Channels 1 through 5 rise to 50 percent. After five seconds, channels 1 through 10 rise to Full. After five seconds, levels drop to zero   |

## Using Macro Editing

The Macro Editing display allows you to create or edit macros without affecting channel levels. Some of the softkeys in this display, such as [S2], **Replace**, and [S7], **More Softkeys**, are for editing purposes only and cannot be entered into a macro. Others, such as [S1], **Select Macro**, and several softkeys available after first pressing [S7], **More Softkeys**, may be entered into a macro. Three keys that cannot be entered into a macro in the Macro Editing display are **Enter Macro**, [←], and [→].<sup>31</sup>



<sup>31</sup>. If your macro needs to contain softkeys that are unavailable in the Macro Editing display, you must use Learn to create it.



Follow these steps to create a macro to record a show to diskette:

<b>Keystrokes:</b>	<b>Action:</b>
1. Press [Setup].	Selects Setup display screen
2. Select 8, <b>Macro Editing</b> , and press [Enter].	Selects Macro display screen Prompt reads: <b>Select macro number, then press ENTER</b>
3. Press [8] [Enter].	Blank macro created Prompt reads: <b>Select operation(s) for this macro – press ENTER MACRO when done (Wheels, trackpad and sliders are not valid entries in macros)</b>
4. Press [Setup] [3] [Enter].	Enters setup display Macro contents line reads: <b>SETUP 3 ENTER</b>
5. Press [1] [Enter].	Selects <b>Write Show To Disk</b> Macro contents line reads: <b>SETUP 3 ENTER 1 ENTER</b>
6. Press [Enter].	Confirms selection Macro contents line reads: <b>SETUP 3 ENTER 1 ENTER ENTER</b>
7. Press [Enter Macro].	Stores macro 8

## ***Macro wait***

To program a pause in the macro, press [Macro Wait] at the point in the macro where you want the pause to occur. Enter the time you would like the macro to hold, then press [Enter]. Continue to enter remaining macro commands.

To program a pause in the macro, in the Macro Editing display, press [S7], **More Softkeys**, and insert [S8], **Macro Wait**, at the point in the macro where you want the pause to occur. Enter the time you would like the macro to hold, then press [Enter].

Times may be expressed in minutes and seconds, or as fractions of seconds (in decimal format). Times can be programmed from 0.1 seconds to 99:59 minutes. Acceptable time values include: 0.2 (.2 seconds), 00:12 (12 seconds), 5.5 (5.5 seconds), or 5:30 (five minutes, 30 seconds).

## Linking macros

Any macro may end with a link to another macro. When macros are linked, the first macro runs, then the second macro follows automatically. Press the appropriate macro key at the end of your sequence to create the link. Pressing the macro key automatically ends and stores the macro.

For example, to create a macro that sets all active channels to 50 percent, fades them out, then runs another macro, follow these steps:

Keystrokes:	Action:
1. Press [Setup] [8] [Enter].	Selects Macro editing mode
2. Press [1] [Enter].	Selects macro 1 to create Prompt reads: <b>Select operation(s) for this macro – press MACRO ENTER when done (Wheels, trackpad and sliders are not valid entries in macros)</b>
3. Press [Enter] [At] [5][0].	Sets all active channels to 50 percent Macro line reads: <b>ENTER AT 5 0</b>
4. Press [Macro Wait][S7], <b>More Softkeys</b> , [S8], <b>Macro Wait</b> , [1][0] [Enter].	Macro pauses for ten seconds Macro line reads: <b>ENTER AT 5 0 Mwait-10</b>
5. Press [At] [0] [Enter].	Fades all active channels out Macro line reads: <b>ENTER AT 5 0 Mwait-10 ENTER AT 0 ENTER</b>
6. Press [M3].	Stores macro. Links macro to macro 3 Macro line reads: <b>ENTER AT 5 0 Mwait-10 ENTER AT 0 ENTER M3</b>

*Note: You may also link a macro to a cue so the macro will run at the same time the cue does. See [Linking a macro to a cue, page 91](#), for more details.*

## Using submasters in macros

Submaster bump buttons can function in macros in three different ways:

1. as a normal bump button;
2. to always fade a submaster to full (regardless of its current condition);
3. to always fade a submaster out (regardless of its current condition).

To include a bump button that starts a timed submaster or changes the direction of a running fade, press the submaster bump button while programming the macro.

Use [S1], **On Sub-Bump**, to fade the submaster up, regardless of its current setting. Use [S2], **Off Sub-Bump**, to fade a submaster out, regardless of its current setting.

To create a macro that turns a submaster on for five seconds, then turns it off, follow these steps:

Keystrokes:	Action:
1. Press [Setup] [8] [Enter].	Selects Macro editing mode
2. Press [4] [Enter].	Selects macro 4 to create Prompt reads: <b>Select operation(s) for this macro – press ENTER MACRO when done (Wheels, trackpad and sliders are not valid entries in macros)</b>
3. Press [S7], <b>More Softkeys</b> , [S1], <b>On Sub-Bump</b> .	Macro line reads: <b>OnBump</b> Prompt reads: <b>Enter submaster number</b>
4. Press [3] [Enter].	Macro line reads: <b>OnBump3</b>
5. Press [Macro Wait][S8], <b>Macro Wait</b> .	Macro line reads: <b>OnBump3 Mwait-0</b>
6. Enter [5] and press [Enter].	Macro line reads: <b>OnBump3 Mwait-5</b>
7. Press [S2], <b>Off Sub-Bump</b> .	Macro line reads: <b>OnBump3 Mwait-5 OffBump</b> Prompt reads: <b>Enter submaster number</b>
8. Press [3] [Enter].	Macro line reads: <b>OnBump3 Mwait-5 OffBump3</b>
9. Press [Enter Macro].	Records macro 4; leaves editing mode
10. Press [Stage] [M4].	Macro runs

## ***Playing macros***

As a macro runs, the LED in the macro's key flashes. Only one macro may run at a time.

To run macros 1 through 5, press the appropriate macro key. For example, to run macro 1, press [M1].

To play a macro recorded in [M1] - [M5], follow these steps:

<b>Keystrokes:</b>	<b>Action:</b>
1. Press [Stage].	Selects Stage display mode
2. Press [M#].	Macro runs; prompt shows sequence of activity as if you were entering the keystrokes

To run any other macro, press [M\*], the number of the macro, and [Enter]. For example, to run macro 10, press [M\*] [1][0] [Enter].

To play a macro without its own key, follow these steps:

<b>Keystrokes:</b>	<b>Action:</b>
1. Press [M*] and enter the macro number.	Prompt reads: <b>Select macro number, then press ENTER</b>
2. Press [Enter].	Macro runs; prompt shows sequence of activity as if you were entering the keystrokes

## ***Canceling a macro***

To cancel a running macro, press [M\*].

## ***Powerup macro***

You may run a macro automatically each time you turn on your console, such as to turn on lights or load a show. To enable the powerup macro feature and select the macro, follow the procedure below.

<b>Keystrokes:</b>	<b>Action:</b>
1. Press [Setup].	Selects the Setup menu
2. Press [6] [Enter].	Selects the Options Settings menu
3. Press [1][0] [Enter].	Selects the Powerup Macro option Prompt reads: <b>Select powerup macro number (Enter 0 to disable)</b>
4. Press [2][0] [Enter].	Selects macro 20 as your powerup macro. Each time you turn on the console, macro 20 runs

# Modifying macros

## Editing mode

In the Macro mode display, you can edit macros in Insert or Replace modes. In Insert mode, if you highlight a keystroke and type another keystroke, the console inserts the new keystroke before the highlighted one. In Replace mode, if you highlight a keystroke and type another keystroke, the console replaces the highlighted keystroke with the new one.

To switch from Insert mode to Replace mode, press [S2], **Replace**. To switch from Replace mode to Insert mode, press [S2], **Insert**. The console indicates the editing mode in the upper left corner of the command display.

## Editing keys

[←] and [→] move the highlight left or right when you are editing a macro.

[S3], **Delete entry**, deletes highlighted keystroke.

# Clearing macros

You must be in Macro display mode to clear individual macros. To clear all macros, you can use the Clear Macros option from the Clear Functions menu, as described on , page 255.

To clear identified macros, follow these steps:

Keystrokes:	Actions:
1. Press [Setup].	Selects Setup display
2. Press [8], <b>Macro Editing</b> , and press [Enter].	Selects Macro display mode
3. Press [S6], <b>Delete Macro</b> .	Prompt reads: <b>To delete macro(s), select macro number(s) and press ENTER To cancel, press CLEAR</b>
4. Press [7]. <sup>a</sup>	Corner reads: <b>Macro 7</b>
5. Press [Enter].	Prompt reads: <b>To confirm, press ENTER To cancel, press CLEAR</b>
6. Press [Enter].	Clears macro 7

<sup>a</sup> In step 4, you may use [And] and [Thru] to enter multiple macros to clear.

## Copying macros

You may want to copy a macro or use macros as building blocks for new macros. To copy contents of one macro to another, follow these steps:

Keystrokes:	Actions:
1. Press [Setup].	Selects Setup display
2. Press [8], <b>Macro Editing</b> , and press [Enter].	Selects Macro display mode Prompt reads: <b>Select macro number, then press ENTER</b>
3. Press [S7], <b>More Softkeys</b> , [S5], <b>Copy Macro</b> .	Prompt reads: <b>To copy macro(s), select macro number(s) to copy and press ENTER</b> <b>To cancel, press CLEAR</b>
4. Press [2]. <sup>a</sup>	Enters the number of the macro you wish to copy Corner reads: <b>Macro 2</b>
5. Press [Enter].	Prompt reads: <b>To copy selected macro(s), select target macro and press ENTER</b> <b>To cancel, press CLEAR</b>
6. Press [2][5], the number of the new macro.	Corner reads: <b>Macro 25</b>
7. Press [Enter].	Macro copy is complete. The contents of macro 2 have been copied into macro 25

<sup>a</sup> In step 4, you may use [And] and [Thru] to enter multiple macros to copy. If you do, the new macros will be numbered consecutively, starting with the macro you enter in step 6.

## Sample macros

To create these sample macros, go to Macro display mode ([Setup] [8] [Enter]), select a macro and enter the keystroke sequences as shown below. More sample macros, created by Expression style console users, are available on ETC's website at [www.etcconnect.com](http://www.etcconnect.com).

### Channel check

This macro brings each channel up to full for a channel check. Before you begin, you'll probably want to bring up at least one channel for working light, then clear all other channels from stage. Press [Stage] and start macro. Press macro key again to check each subsequent channel.

[At] [0] [Enter] [+] [Full]  
Macro line reads: **At 0 Enter + Full**

## ***Auto channel check***

This macro automatically runs through each channel with a two second wait between each channel, beginning with channel 1. You can effectively pause the check by cancelling the macro at any channel. If you replay the macro after the cancellation, the check begins at the next channel in sequence.

[At] [0] [Enter] [+] [Full] [Macro Wait] [2] [Enter] [M#]  
Macro line reads: **At 0 Enter + Full Mwait2 M#**  
(# = this macro's macro number)

## ***Turn off all lights except work lights***

This macro captures all channels and sets them to zero. This overrides all faders and submasters. Then the macro sets work lights at full. You can easily return to previous settings by pressing [Rel] to release captured channels.

[Channel] [1] [Thru] [-] [At] [0] [Enter] [#] [Full]  
Macro line reads: **Chan 1 Thru - At 00 Enter Chan # Full** (#=work lights channel)

## ***Clear faders and turn work lights on***

This macro clears both faders and selects work lights.

[Clear AB] [Clear CD] [Channel] [#] [Full]  
Macro line reads: **Clear-AB Clear-CD Chan # Full**  
(#=work lights channel)

## ***Clear unused channels in Flexichannel mode***

This macro clears channels that are visible, but no longer in use. (Because this macro uses a softkey, you must create it using Learn.)

[Setup] [1] [Enter] [S1] [Stage]  
Macro line reads: **Setup 1 Enter PurgeFlexi Stage**

## ***Record show on disk***

This macro records the current show on disk.

[Setup] [3] [Enter] [1] [Enter] [Enter]  
Macro line reads: **Setup 3 Enter 1 Enter Enter**





# ***Chapter 19***

## ***Link lists***

Console channels can control devices that have more than one controllable feature, such as a color scroller. By linking channels using the console's Link List, you can link channels together for simultaneous control on the trackpad. Any channel not used in ML Fixture Patch may be linked.

This chapter contains the following sections:

- Link List overview
- Setting up a link
- Using a link
- Modifying links

## Link List overview

Press [Setup] [1][1], **Channel Attributes**, [Enter] [S7], **Link List**, to reach the Link List display

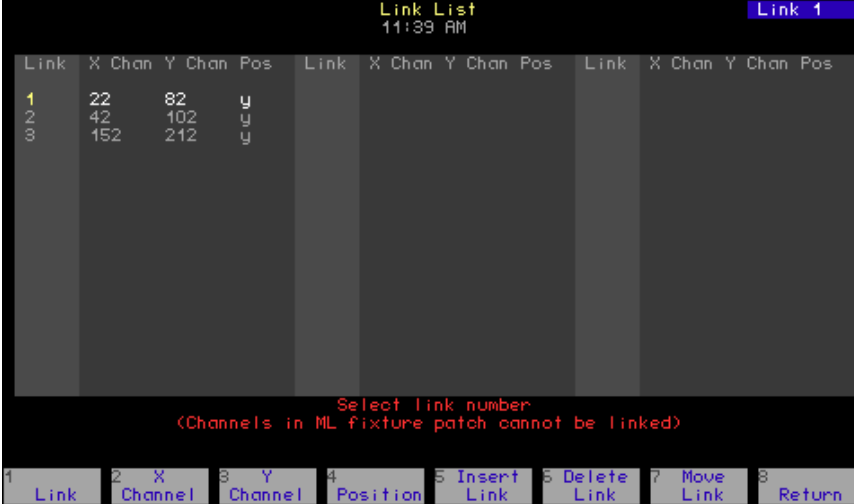

The screenshot shows a terminal window titled "Link List" with the time "11:39 AM" and "Link 1" in the top right corner. The main display area contains a table with three columns: "Link", "X Chan", and "Y Chan". The "Link" column has three entries: 1, 2, and 3. The "X Chan" column has values 22, 42, and 152. The "Y Chan" column has values 82, 102, and 212. The "Pos" column has three entries, all of which are "y". Below the table, there is a red prompt "Select link number" and a note "(Channels in ML fixture patch cannot be linked)". At the bottom of the screen, there is a navigation bar with eight buttons: 1 Link, 2 X Channel, 3 Y Channel, 4 Position, 5 Insert Link, 6 Delete Link, 7 Move Link, and 8 Return.

Link	X Chan	Y Chan	Pos
1	22	82	y
2	42	102	y
3	152	212	y

Select link number  
(Channels in ML fixture patch cannot be linked)

1 Link 2 X Channel 3 Y Channel 4 Position 5 Insert Link 6 Delete Link 7 Move Link 8 Return

When two or more channels are used together, such as the color and intensity channels for a color scroller, the Link List allows you to determine which axis of the trackpad will control each channel. When you select a channel, it is placed under the control of one axis of the trackpad and all channels linked to it are also selected and placed under control of the other trackpad axis.

Links may contain up to ten channels on each of the X and Y lists. Channels on the X list are controlled by the X-axis and are shown in gold in displays; channels on the Y list are controlled by the Y-axis and are shown in yellow in displays. Each channel may appear in only one link. All channels in a link from one list are selected if any channel is selected from the other list.

## Setting up a link

To set up a link, you must assign at least one channel to the X channel list and one channel to the Y channel list. In the following example, two color scrollers are linked so that their color settings are controlled by the trackpad. For the two scrollers, color is controlled by channels 1 and 11, respectively.

To link two channels, follow these steps:

<b>Keystrokes:</b>	<b>Action:</b>
1. Press [Setup] [1][1] [Enter].	Selects Channel Attributes display
2. Press [S7], <b>Link List</b> .	Selects Link List display Prompt reads: <b>Select link number (Channels in ML fixture patch cannot be linked)</b>
3. Press [1] [Enter].	Selects link number, for instance 1. Prompt reads: <b>Select X channel number(s) (Precede with AND to add to existing link, or EXCEPT to delete from link)</b>
4. Press [1] [→].	Channel 1 is assigned to the link's X list. Prompt reads: <b>Select Y channel number(s) (Precede with AND to add to existing link, or EXCEPT to delete from link)</b>
5. Press [1][1] [→].	Channel 11 is assigned to the link's Y list. Set the trackpad mode for this link Prompt reads: <b>Select fixture type, then press ENTER (1=XY position, 0=other) Select link number (Channels in ML fixture patch cannot be edited)</b>
6. Press [0] [→]. <sup>a</sup>	The link sets the trackpad to double mode. Link entry is complete
7. Go back to step 3.	Create additional links, if needed

<sup>a</sup> The position column pertains to the mode in which the trackpad operates for linked channels. See [Using the trackpad, page 9](#), for information about the XY and double modes of trackpad operation.

## Inserting a link

Use the edit features softkey [S5], **Insert Link**, to insert an empty link number ahead of the selected or specified link. All subsequent links will be renumbered.

*Note: The order in which links are recorded does not affect their operation. However, your numbering may be useful to you in terms of logical organization.*

To insert a link, follow these steps:

- | <b>Keystrokes:</b>                              | <b>Action:</b>   |
|---|--|
| 1. Press [Setup] [1][1] [Enter].                | Selects Channel Attributes display   |
| 2. Press [S7], <b>Link List</b> .               | Selects Link List display<br>Prompt reads:<br><b>Select link number</b>  |
| 3. Press [S5], <b>Insert Link</b> .             | Prompt reads:<br><b>Select link number to insert, then press ENTER.</b><br><b>To cancel, press CLEAR.</b>  |
| 4. Press [1] [Enter].                           | Selects link 1 to insert. All links higher than 1, up to the first gap in the Link List (if any), are renumbered to make room<br>Prompt reads:<br><b>Select X wheel channel number (Precede with AND to add to existing link, or EXCEPT to delete from link)</b> |
| 5. Proceed with normal link entry. <sup>a</sup> |  |

<sup>a</sup> See [Setting up a link, page 239](#).

## Moving a link

Use [S7], **Move Link**, to renumber a link or a group of links. All links in a group will be renumbered sequentially.

To move a link to an empty space on the Link List, follow these steps:

<b>Keystrokes:</b>	<b>Action:</b>
1. Press [Setup] [1][1] [Enter].	Selects Channel Attributes display
2. Press [S7], <b>Link List</b> .	Selects Link List display Prompt reads: <b>Select link number</b>
3. Press [S7], <b>Move Link</b> .	Prompt reads: <b>Select link number(s) to move, then press ENTER</b> <b>To cancel, press CLEAR.</b>
4. Press [6] [Enter].	Prompt reads: <b>To move selected link(s), select target link and press ENTER</b> <b>To cancel, press CLEAR</b>
5. Press [9] [Enter].	Link 6 is renumbered as link 9

## Merging two links

If you move a link to a space on the Link List which already contains a link, the channels in the moved link are added to the existing link.

To move a link to an occupied space on the Link List, follow these steps:

<b>Keystrokes:</b>	<b>Action:</b>
1. Press [Setup] [1][1] [Enter].	Selects Channel Attributes display
2. Press [S7], <b>Link List</b> .	Selects Link List display Prompt reads: <b>Select link number</b>
3. Press [S7], <b>Move Link</b> .	Prompt reads: <b>Select link number(s) to move, then press ENTER</b> <b>To cancel, press CLEAR.</b>
4. Press [6] [Enter].	Prompt reads: <b>To move selected link(s), select target link and press ENTER</b> <b>To cancel, press CLEAR</b>
5. Press [7] [Enter].	Prompt reads: <b>Link already exists –</b> <b>To confirm, press ENTER</b> <b>To cancel, press CLEAR</b>
6. Press [Enter].	The channels in link 6 are added to the channels in link 7

*Note: To split a link apart, create a new link with the channels you want to move. Since a channel can only be in one link at a time, it will be deleted from the original link and recorded in the new link.*

## Deleting a link

Use [S6], **Delete Link**, to remove a link from the Link List. All subsequent links will be renumbered.

To delete a link, follow these steps:

<b>Keystrokes:</b>	<b>Action:</b>
1. Press [Setup] [1][1] [Enter].	Selects Channel Attributes display
2. Press [S7], <b>Link List</b> .	Selects Link List display Prompt reads: <b>Select link number</b>
3. Press [S6], <b>Delete Link</b> .	Prompt reads: <b>Select link number(s) to delete, then press ENTER (Enter 0 to delete all links)</b>
4. Press [5] [Enter].	Prompt reads: <b>To confirm, press ENTER To cancel, press CLEAR</b>
5. Press [Enter].	The link is deleted from the Link List. All links with higher numbers are renumbered one lower

## Using a link

Once you have linked the color control channels for the two color scrollers, the console allows you to control them simultaneously on the trackpad. If you move in just the X or Y direction only, the color will change only on the corresponding scroller.

To control the scrollers, follow these steps:

<b>Keystrokes:</b>	<b>Action:</b>
1. Press [Stage].	Selects Stage display
2. Press [1].	Selects channel 1. Channel number is gold, signifying that it is assigned to the X list. Through the link, selects channel 11. Channel number is yellow, signifying that it is assigned to the Y list
3. Place your finger in the lower left corner of the trackpad and slowly move it toward the upper right corner.	The levels on both channels rise together, each controlled by an axis of the trackpad. As they do, the colors change on the color scrollers, corresponding to the levels. Both axis' levels are displayed in the prompt corner

# Chapter 20

## Diskette functions



This chapter includes instructions for using console diskette options. The console is equipped with a 3.5-inch disk drive on the console's right end panel.

The following options are described in this chapter:

- Diskette management
- Formatting diskettes
- Writing to diskette
- Reading show, configuration or all information from diskette

## Diskette management

The console lets you save one show on a double-sided, high density (1.44 MB) 3.5-inch diskette. This feature allows you to back up your shows for safety. It also allows you to transfer your shows to other consoles, work on more than one show at a time and use more than 600 cues in a show by loading a second show into memory.<sup>32</sup>

Label each diskette carefully and clearly to help you keep track of what show is on the diskette. You can also use any of the Read options to find out the name of the show and when it was transferred to diskette.<sup>33</sup>

Before you can use a diskette in the console, you must format it on the console or on an IBM PC-compatible with a high-density drive. Formatting instructions using the console are given in this chapter.

### Storing diskettes

- Store diskettes at a temperature between 50 and 140 degrees Fahrenheit.
- Keep diskettes away from magnets, magnetized objects or heavy electrical equipment, including large lighting equipment.
- Do not touch the magnetic disk inside the plastic diskette case.

### Formatting diskettes

**WARNINGS:** *Formatting a diskette erases all information recorded on the diskette. Formatting stops any fade in progress. When formatting is complete, the fade jumps to the point it would have reached if it hadn't been interrupted.*

Before you can use a diskette in the console, you must format it on either the console or an IBM-compatible personal computer.

To format a diskette with the console, insert a diskette into the console's disk drive and follow these steps:

Keystrokes:	Action:
1. Press [Setup].	Selects Setup display
2. Press [3], <b>Disk Functions</b> , [Enter].	Selects Diskette Functions menu
3. Press [4], <b>Format Disk</b> , [Enter].	
4. Press [Enter].	Formats the diskette. Prompt appears: <b>Formatting disk - Do not remove from drive.</b>

---

<sup>32</sup>. See [The oversized show, page 82](#).

<sup>33</sup>. See [Expression Off-Line, page 306](#), to name a show in Expression Off-Line.



## Contents of the showfile

When you write to diskette, everything that you programmed into your show and everything that you set in the console to make that show happen are stored in a single showfile. Show and configuration information, however, may be read separately from the showfile.<sup>34</sup>

The System Configuration contents of the showfile are defined as all those things you set in the console that commonly remain the same for all shows. Show contents of the showfile contain certain other settings, such as changes in defaults that are likely to be set for a specific show, and all those programmed elements of the show that directly control the lights, including the patching, cues and dimmer settings. A complete accounting of showfile contents, broken down into Show and System Configuration components, is given in [Appendix D Showfile, page 331](#).

## Writing to diskette

Write a showfile to diskette with the following procedure.<sup>35</sup>

Keystrokes:	Action:
1. Insert a formatted diskette in disk drive.	
2. Press [Setup].	Selects Setup display
3. Press [3], <b>Disk Functions</b> , [Enter].	Selects Diskette Functions menu
4. Press [1], <b>Write All to Disk</b> , [Enter].	Screen clears and Record window appears
5. Press [Enter], or press [Clear] to cancel the operation.	Message in record window appears and remains until show is recorded: <b>To disk in progress.</b>

---

<sup>34.</sup> System configuration information was not saved on diskette for shows recorded prior to version 3.03 software.

<sup>35.</sup> When writing, any fades executing at that time are interrupted. These fades resume when writing to diskette is complete.

## Reading from diskette

You can read either the show or the system configuration contents of a showfile, or you can read both together. See [Appendix D Showfile, page 331](#), for a breakdown of what components are stored in each.

**CAUTION:** The information you read from diskette takes the place of whatever you had before the read in your console's memory.<sup>36</sup> If you want to keep the show and configuration settings currently in memory, write them to diskette before the read.

You may read from diskette in the middle of a performance, but you should wait until no fades are taking place. Any fades in progress are stopped during the read and resume when the read is complete. Fader and submaster outputs are maintained as the new show loads.

### Read show and configuration

Follow the procedure below to read both the show and the system configuration components at once.

Keystrokes:	Action:
1. Insert diskette in disk drive.	
2. Press [Setup].	Selects Setup display
3. Press [3], <b>Disk Functions</b> , [Enter].	Selects Diskette Functions menu
4. Press [5], <b>Read All from Disk</b> , [Enter].	Screen clears and Read All window appears
5. Press [Enter], or press [Clear] to cancel the operation.	Message in record window appears and remains until read is complete: <b>From disk in progress.</b>

---

<sup>36</sup> If you are using the Designer's Worksheet option and your setup is different in the new show, a message will warn you.

## ***Read show components only***

Frequently you do not need to overwrite system configuration settings but only want a different showfile in console memory. For that purpose, read show contents only into memory with the following procedure:

<b>Keystrokes:</b>	<b>Action:</b>
1. Insert diskette in disk drive.	
2. Press [Setup].	Selects Setup display
3. Press [3], <b>Disk Functions</b> , [Enter].	Selects Diskette Functions menu
4. Press [2], <b>Read Show From Disk</b> , [Enter].	Screen clears and Read Show window appears
5. Press [Enter], or press [Clear] to cancel the operation.	Message in record window appears and remains until read is complete: <b>From disk in progress.</b>

## ***Read system configuration components only***

Follow the procedure below if you want to restore your system configuration to one written previously to a diskette.<sup>37</sup>

<b>Keystrokes:</b>	<b>Action:</b>
1. Insert diskette in disk drive.	
2. Press [Setup].	Selects Setup display
3. Press [3], <b>Disk Functions</b> , [Enter].	Selects Diskette Functions menu
4. Press [3], <b>Read System Configuration From Disk</b> , [Enter].	Screen clears and Read System Parameters window appears
5. Press [Enter], or press [Clear] to cancel the operation.	Message in record window appears and remains until read is complete: <b>Read system configuration in progress.</b>

---

<sup>37.</sup> *System configuration information was not saved on diskette for shows recorded prior to version 3.03 software.*



# Chapter 21

## Printing

The console supports parallel printers, including some laser printers. Printer installation is described in [Installing a printer, page 315](#). This chapter includes instructions for using the console's print options. the following printouts are introduced and explained in this chapter.

- Stage display
- Cues
- Groups
- Submasters
- Cue list
- Group list
- Submaster list
- Macros
- Patch
- Profiles
- Channel attributes
- Real Time Programs
- Time Code events
- Focus Points
- Focus Points List
- Moving Lights

## Printer options

Before you begin printing, verify that your printer is installed correctly and that it is turned on. For instructions on installing printers, see [Installing a printer, page 315](#).

All print options are located on the Print Functions menu. To display the menu press [Setup], then select [5], **Print Functions**, and press [Enter]. The console displays the Print Functions menu illustrated below.



You may pause the current printing job or cancel it at any time while printing. To stop the printer temporarily while it is printing, press [S2], **Pause Printer**. The printer prints a few more lines, then stops and waits. Press [S2] again to resume printing. To cancel a print job, press [S1], **Stop Printer**. The printer prints a few more lines, then stops.

## Printing procedure

Follow the procedure below for all printouts. This example shows the prompts for the Print Stage Display option on the Print Functions menu. Use this procedure for all printout options, varying as directed by the onscreen prompts.

Keystrokes:	Action:
1. Press [Setup].	Displays Setup menu
2. Press [5], <b>Print Functions</b> , [Enter].	Displays Print Functions menu
3. Press [1], <b>Print Stage Display</b> , [Enter].	Prompt reads: <b>To confirm, press ENTER</b> <b>To cancel, press CLEAR</b>
4. Press [Enter].	File sent to the printer

## ***Printouts available***

Following is a list of all 17 options on the Print Functions menu and an explanation of the printout each will produce.

1. **Stage Display** - Reports the settings of all channels on stage.
2. **Cues** - Lists cues in the show by number and attributes. Also gives the levels of all channels in each cue.
3. **Groups** - Lists all groups in the show by number and label. Also gives the levels of all channels in each group.
4. **Submasters** - Lists all 240 submaster memories, by submaster number; upfade, dwell and downfade times; rates and labels. Also gives the levels of all channels included in each submaster.
5. **Cue List** - Lists cues in the show by number and attributes.
6. **Group List** - Lists all groups in the show by number and label.
7. **Submaster List** - Lists all 240 submaster memories, by submaster number; upfade, dwell and downfade times; rates and labels.
8. **Macros** - Lists macro sequences in the show by macro number.
9. **Patch** - Prints the current dimmer-to-channel patch.
10. **Profiles** - Lists all 32 profiles and their fade point intensities in the show.
11. **Channel Attributes** - Lists Channel Attributes, including link lists, recorded in the show.
12. **Real Time Programs** - Lists Real Time Programs in the show, with complete information.
13. **Time Code Events** - Lists all Time Code events in the show, with complete information.
14. **Focus Points** - Lists all focus points in the show by number and label. Also gives the levels of all channels in each focus point.
15. **Focus Point List** - Lists all focus points in the show by number and label.
16. **Moving Lights** - This selection brings up the Print Moving Lights menu. See the explanation below of the four choices on this menu.

## ***Moving lights***

The Moving Lights option from the Print Functions menu brings up an additional menu called the Print Moving Lights menu. The four options on this menu and the printouts they produce are explained below.

1. **Personalities** - Lists all personalities in the show and identifies the attributes of each by channel order, name, data type, independent status, LTP status and Flip status.
2. **Fixture Patch** - Lists all fixtures in the show according to all parameters in fixture patch. Also identifies the channel assigned to the fixture's intensity attribute.
3. **Attribute Setup** - Lists the setup in the show for all 64 attributes by number, name and category of assignment.
4. **Encoder Setup** - Lists the page-by-page setup in the show for all five encoders, for the two wheels and for the two axes of the pointing device, if installed.





# ***Chapter 22***

## ***Clear functions***

This chapter includes instructions for using the console's clear options. Each of the following clear functions is explained and illustrated on the following pages.

- Show
- Cues
- Groups
- Submasters
- Show and patch
- Focus points
- Macros
- Reset patch
- Reset profiles
- Channel attributes
- Real Time Programs
- Time code events
- Moving lights

## Clear functions

Each option on the Clear Functions menu erases information regarding a console function from the console's memory. If that information is saved in a show on a diskette, it can be restored to the console. Otherwise, the information is lost permanently.

*Warning: Be certain to save your shows on disk before erasing information you may need in the future. See [Chapter 20 Diskette functions](#), page 243, for information about saving shows.*

All clear options are located on the Clear Functions menu. To display the menu, press [Setup], then select [4], **Clear Functions**, and press [Enter]. The console displays the Clear Functions menu illustrated below.



## Clear and reset procedure

Follow the procedure below for all clears and resets. This example shows the prompts for the Clear Show option from the Clear Functions menu. Use this procedure for all clear and reset options, varying as directed by the onscreen prompts.

Keystrokes:	Action:
1. Press [Setup].	Displays Setup menu
2. Press [4], <b>Clear Functions</b> , [Enter].	Displays Clear Functions menu Prompt reads: <b>Select function number, then press ENTER</b>
3. Press [1], <b>Clear Show</b> , [Enter]. <sup>a</sup>	Prompt reads: <b>To clear show data, press ENTER</b> <b>To cancel, press CLEAR</b>
4. Press [Enter].	Show cleared. Returns to Stage display mode

<sup>a</sup> Press softkey [S1], **Reset System**, here to erase all show information from the console, reset to a 1-to-1 patch and reset the system, options and configuration to factory defaults.

## ***Clear and reset options***

Following is a list of all 14 options on the Clear Functions menu and an explanation of the function of each.

1. **Show** - Erases all information pertaining to the show except patch information and the system configuration.
2. **Cues** - Erases all recorded cues from the show.
3. **Groups** - Erases all recorded groups from the show.
4. **Submasters** - Erases all recorded submasters from the show.
5. **Show and Patch** - Erases all information pertaining to the show. Unaffected are system settings, options settings and the I/O configuration. See [Reset System](#), next page, for clearing everything to defaults.
6. **Focus Points** - Erases all recorded focus points from the show.
8. **Macros** - Erases all macro information from the show.
9. **Reset Patch 1-to-1** - Resets to a one-to-one patch. Thus, channel 1 is patched to dimmer 1, channel 2 is patched to dimmer 2, and so on. This function is independent of your show and does not clear label, level or profile settings. See [Chapter 4 Patching channels, page 35](#), for more information about patch.
10. **Reset Profiles** - Returns all dimmer profiles to their preset curves. Profiles 1-9 return to their preset curves identified under [Dimmer profiles, page 40](#). Profiles 10-32 all return to a linear curve.
11. **Channel Attributes** - Erases all channel attribute information, including link lists, from the show.
12. **Real Time Programs** - Erases all Real Time Programs from the show.
13. **Time Code Events** - Erases all Time Code information from the show.
15. **Moving Lights** - Unpatches all fixtures and restores the defaults for personalities, encoders and attributes.



# *Chapter 23*

## *Dimmer monitoring*

ETC consoles may be connected to ETC Sensor dimming systems via the ETCLink communication protocol. In this configuration, the console operates a dimmer monitoring system that provides you with a wide range of dimmer status information, including overall dimming system status and specific information about individual dimmer modules and dimmer racks.

Your window on ETCLink is through the ETCLink Functions menu. Most of the dimmer, rack and dimming system information provided by console displays is also provided by the the Control Electronics Module (CEM) of your Sensor dimming system.

Consult this chapter for information on the following topics:

- Enabling ETCLink
- Enabling / disabling ETCLink error messages
- Recording, checking and clearing dimmer loads
- Examining overall dimming system status
- Examining rack status
- Examining dimmer status
- Setting / unsetting dimmers with ETCLink
- Using Sensor backup looks

# ETCLink functions

Go to the ETCLink Functions menu by pressing [Setup] [9] [Enter]. Make selections from this menu to branch to the variety of options available in your dimmer monitoring system.

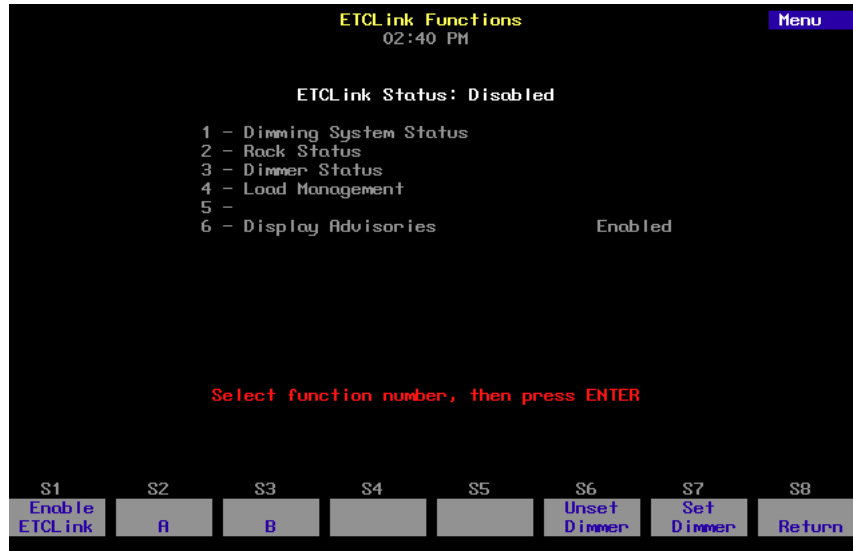

## Enabling ETCLink

Before using ETCLink functions, you must enable your console to work with the ETCLink network. After enabling the connection, you should decide how to handle error advisory messages. See [Error messages, page 259](#).

Following is one of two ways to enable ETCLink. You may also enable ETCLink using softkey [S1] in the ETCLink Functions menu, shown above.<sup>1</sup>

Keystrokes:	Action:
1. Press [Setup].	Selects Setup menu.
2. Select 6, <b>Options Settings</b> , and press [Enter].	Selects Options Settings menu
3. Press [8], <b>ETCLink</b> , [Enter].	Prompt reads: <b>Enable/disable ETCLink (1 = Enable, 0 = Disable)</b>
4. Press [1] [Enter].	Dimmer Monitoring is enabled

---

<sup>1</sup> Note that option 9 in the Options Settings menu provides for an ETCLink address setting, which is related to operating more than one console on ETCLink. The default value is 1, and generally should be left as is. If you have questions about this setting, please call ETC Technical Services at 800-775-4382.

# Error messages

ETCLink provides messages for a wide variety of conditions, including information regarding your dimmers, racks, system, data, ports, and loads. These messages fall into two categories, fatal messages and secondary messages.<sup>2</sup>

Fatal messages deal with anything that could potentially terminate or drastically change the look of your show. You may set fatal messages to be displayed even when secondary messages have been disabled.

Secondary messages deal with individual dimmer problems and warnings of potential rack temperature problems. These messages are generally less critical than the fatal messages. If you wish, secondary messages may be disabled without disabling fatal messages. The procedure for enabling or disabling ETCLink error messages is given in the next section.

The console shows error messages in pop-up advisory windows that appear regardless of which display mode you have chosen. They may also appear in abbreviated forms on the Status and About screens.<sup>3</sup> Advisories are cleared as soon as you enter any keystroke. An example of such an Advisory message is shown below.



2. See [ETCLink errors, page 328](#), for a listing of errors.
3. To identify errors on specific dimmers, see [About Dimmer with ETCLink, page 47](#).

## ***How to enable / disable ETCLink error messages***

### **Keystrokes:**

1. Press [Setup].
2. Press [9], **ETCLink Functions**, [Enter].
3. Press [6], **Display Advisories**, [Enter].
4. Press [1] [Enter].

### **Action:**

Selects Setup display

Selects ETCLink Functions menu

Prompt reads:

**Enable/disable display of ETCLink advisories**

**(1 = Enable all, 2 = Enable fatal error advisories only, 0 = Disable)**

Enables all ETCLink error advisories



# ETCLink displays

## Dimming system status

The System Status display provides information about your Sensor dimming system. Press [Setup] [9] [Enter] [1] [Enter] to access the System Status display.

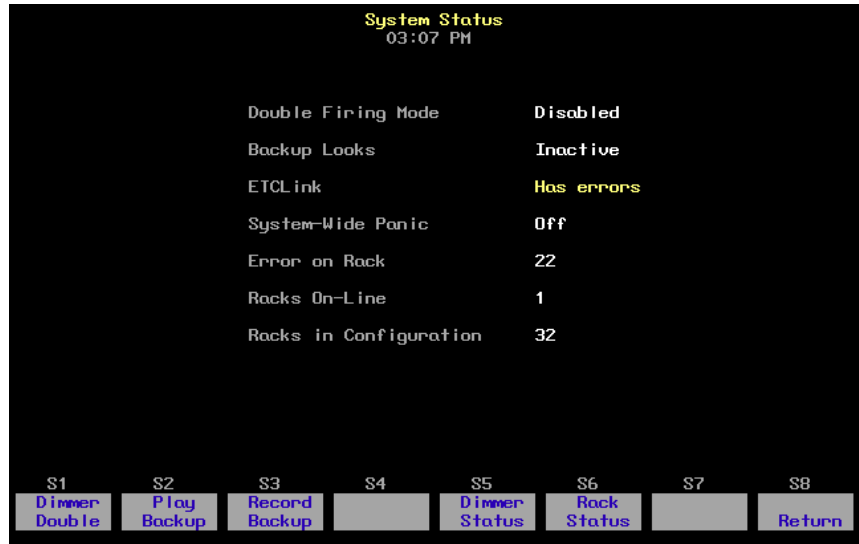

- **Double Firing Mode** shows whether that mode is enabled or disabled for your system. If Double Firing Mode is disabled, doubled dimmers function as normal dimmers.
- **Backup looks** indicates whether a backup look is active, and, if so, which one.
- **ETCLink** displays any ETCLink errors.
- **System-wide panic** displays status of system-wide panic.
- **Error on rack** displays the number of the rack with an ETCLink error. If errors exist on multiple racks, the first rack with an error is displayed.
- **Racks on-line** displays the number of racks presently on-line throughout the ETCLink network.
- **Racks in configuration** displays the total number of racks in the system.

## Dimmer rack status

The Rack Status display provides information about specified dimmer racks, including rack type, starting address, port information, voltage, frequency, and ambient temperature.

Press [Setup] [9] [Enter] [2] [Enter] to access the Rack Status display. Press [S6], **Select Rack**, [#] [Enter] to select a specific rack, [+], to select the next rack, or [-] to view the previous rack.

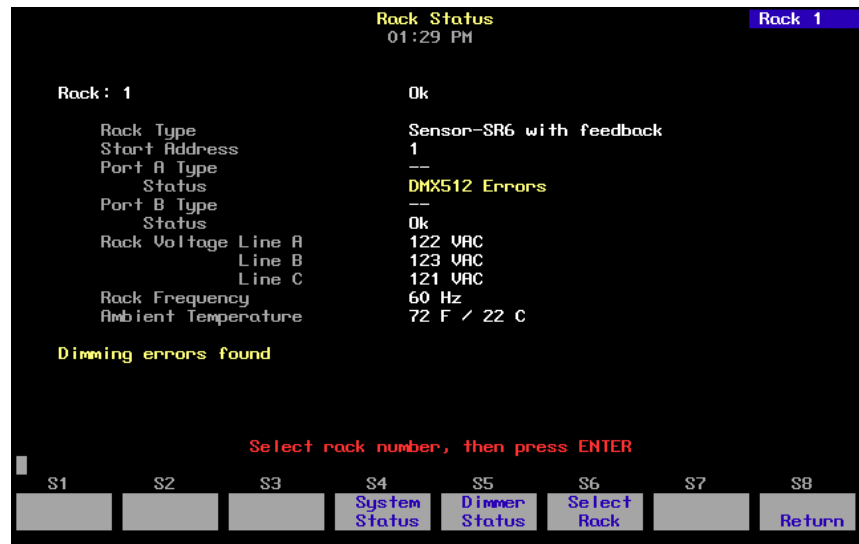

- **Rack type** displays the type of Sensor rack this rack is. Possible rack types include SR6, SR12, SR24, SR36, SR48, SP6, SP12, SP24, SP48, and may be followed by AF if the rack is equipped with Sensor's Advanced Features option.
- **Start address** displays the lowest dimmer number in the rack.
- **Port A/B type** indicates whether the port is normal or Dimmer Doubled. "--" indicates a normal port.
- **Status** indicates the present status of the port.
- **Rack voltage** displays the input voltage for each of the three phases (A, B and C). Single phase racks only display values for A and C.
- **Rack frequency** displays the input frequency in hertz (Hz).
- **Ambient temperature** displays the temperature of the air drawn into the rack by the rack's fan. Ambient temperature is not displayed unless the fan is running.

Rack error messages, if any, are announced beneath the ambient temperature line.

## Dimmer status

The Dimmer Status display provides information about dimmers, including size and type, recorded load, firing mode, output curve, rack, slot, panic mode, and boost. Press [Setup] [9] [Enter] [3] [Enter] to access the Dimmer Status display.

Dimmer Status								
03:09 PM								
No errors								
Dimmer	Type	Recorded Load	Firing Mode	Curve	Rack	Slot	Panic Mode	Scale/Boost
250	Not Installed							
251	Not Installed							
252	Not Installed							
253	D15AF	1250W	--	Mod Square	22	1	--	116V
254	D15AF	950W	--	Mod Square	22	1	--	116V
255	D15AF	0W	--	Mod Square	22	2	--	116V
256	D15AF	0W	--	Mod Square	22	2	--	116V
257	D15AF	0W	--	Mod Square	22	3	--	116V
258	D15AF	0W	--	Mod Square	22	3	--	116V
259	D15AF	0W	--	Mod Square	22	4	--	116V
260	D15AF	0W	--	Mod Square	22	4	--	116V
261	D15AF	0W	--	Mod Square	22	5	--	116V
262	D15AF	0W	--	Mod Square	22	5	--	116V
263	D15AF	0W	--	Mod Square	22	6	--	116V
264	D15AF	0W	--	Mod Square	22	6	--	116V
265	Not Installed							

Press [+] or [-] to page through dimmers

S1	S2	S3	S4	S5	S6	S7	S8
			System Status	Select Dimmer	Rack Status		Return

Up to 16 dimmers are shown in the display at once. If a dimmer has an error condition, the entire dimmer row is highlighted in yellow (ordinarily the line is in gray). Dimmer errors are also identified in the About Dimmer display. See [About Dimmer with ETCLink, page 47](#).

Press [S5], **Select Dimmer**, [#] [Enter] to select a specific dimmer or use [+] and [-] keys to move through the list of dimmers a page at a time. Following is an explanation of column contents.

- **Type** identifies the ETC type designation.
- **Recorded load** displays the load at which the selected dimmer was recorded.
- **Firing mode** identifies whether the dimmer is normal, doubled, or switched. "--" indicates a normal firing mode.
- **Curve** identifies the output curve assigned to the dimmer.
- **Rack** identifies the dimmer's rack number.
- **Slot** identifies the dimmer's slot number in the rack.
- **Panic mode** identifies whether the dimmer is assigned to a panic circuit. "--" indicates an unassigned dimmer.
- **Scale/Boost** indicates either the dimmer's Scale or Boost value. Either can be returned for each dimmer depending upon the rack's CEM software. Scale is expressed in voltage and indicated by a "V" following the number. Boost is expressed in percentage and indicated by a "%" following the number. A non-boosted level of 100 percent is indicated by the symbol "--".

## Monitoring dimmers

When used in conjunction with Sensor Advanced Feature dimming equipment, the console allows you to monitor individual dimmer loads in your system. This can greatly simplify troubleshooting by identifying such things as burned out lamps, and incorrectly lamped or unplugged fixtures.

When dimmer monitoring is in use, Sensor electronics constantly monitor dimmer loads. Monitoring information is displayed by the dimming system and also sent to the console.

To use this monitoring information efficiently, you must first determine what constitutes a normal load. The console procedure for determining normal loads is called Record Loads, and it is explained in the next section. You may also perform a Record Loads procedure from the Sensor system.<sup>4</sup>

### Load Management display

The Load Management lists dimmers for which load errors have been detected, either by the Sensor system or by a Load Check you initiated. If you have a printer attached to your system, you may print the data shown in the Load Management display by pressing [S1], **Print Screen**. An example of a Load Management display is shown below.

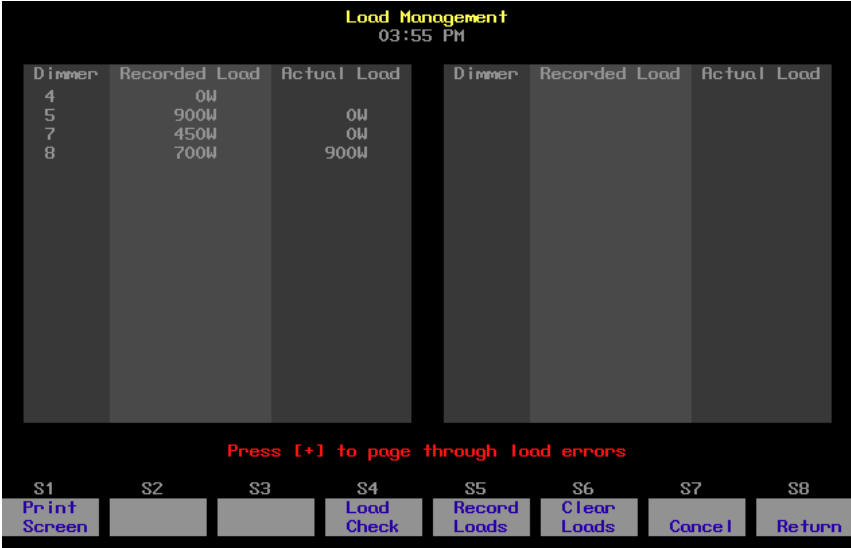

The screenshot shows a console display titled "Load Management" with the time "03:55 PM". It displays two tables side-by-side. The left table shows recorded and actual loads for dimmers 4, 5, 7, and 8. The right table is empty. Below the tables is a red instruction: "Press [+] to page through load errors". At the bottom are eight function keys labeled S1 through S8 with their respective actions: S1 (Print Screen), S2 (blank), S3 (blank), S4 (Load Check), S5 (Record Loads), S6 (Clear Loads), S7 (Cancel), and S8 (Return).

Dimmer	Recorded Load	Actual Load	Dimmer	Recorded Load	Actual Load
4	0W				
5	900W	0W			
7	450W	0W			
8	700W	900W			

Press [+] to page through load errors

S1	S2	S3	S4	S5	S6	S7	S8
Print Screen			Load Check	Record Loads	Clear Loads	Cancel	Return

If load errors are reported for many dimmers, Use [Page +] and [Page -] to page through the display.

- **Recorded Load** lists the loads determined for the listed dimmers during a Record Loads procedure.
- **Actual Load** lists the current loads for the listed dimmers.

---

<sup>4</sup> Loads may not be recorded on Sensor systems without the AF option. See the Sensor CEM Users Manual for more information on recording loads from your dimming system.

## Record Loads procedure

Perform a Record Loads any time you relamp your fixtures, change the type of fixtures you are using, change the dimmer numbering scheme, or make any other significant changes to your system. In general, Record Loads should be the last step in setting up your system.

When you perform a Record Loads, the system records load information for dimmers set at a level above zero or for a list of dimmers. If setting dimmers above zero, you can record 24 dimmers per rack at a time until all non-zero dimmers have been recorded. If you have multiple racks, 24 dimmers in each rack are recorded simultaneously.<sup>5</sup>

**Caution:** Record Loads changes levels on stage. Dimmer outputs rise and fall for several minutes during the procedure. To cancel a Record Loads operation that has already started, press [S7], **Cancel**, [Enter].

Keystrokes:	Action:
1. Set desired dimmers to a level above zero. <sup>a</sup> Only dimmers at levels above zero are recorded.	
2. Press [Setup].	Selects Setup display
3. Select [9], <b>ETCLink Functions</b> , and press [Enter].	Selects ETCLink Functions menu
4. Select [4], <b>Load Management</b> , and press [Enter].	Selects Load Management display
5. Press [S5], <b>Record Loads</b> . If you wish, you may enter a specific dimmer or dimmers to record.	Prompt reads: <b>To record loads, select dimmer(s) and press ENTER (Enter 0 to record loads for all dimmers)</b>
6. Press [0] [Enter].	Advisory reads: <b>New loads will be recorded for all dimmers with levels above zero. Levels on stage will change while the Record Load is in progress. The system will automatically vary the dimmer outputs during the Record Load. The process may take several minutes to complete.</b>
	Press [Enter] to proceed, or press [Clear] to cancel
7. Press [Enter].	New loads are recorded for all dimmers with levels above zero
	<i>a. If you wish, instead of setting the desired dimmers to a level in step 1, you may enter a list of dimmers to record in step 5.</i>

---

<sup>5.</sup> On single phase racks, the system checks 16 dimmers per rack at a time.

## Load Check procedure

Load Check compares the current load on selected dimmers with their recorded loads. The system checks load information only for selected dimmers. To identify the dimmer(s) you wish to check, use either the console or the CEM to set the desired dimmers at a level above zero.

The system checks 24 dimmers per rack at a time until all dimmers at levels above zero have been checked. If you have multiple racks, 24 dimmers in each rack are checked simultaneously.<sup>6</sup>

**Caution:** *Load Check changes levels on stage. Dimmer outputs rise and fall for several minutes during the procedure. To cancel a check load operation in progress, press [S7], **Cancel**, [Enter].*

Follow these steps to check loads for your system:

Keystrokes:	Action:
1. Set dimmers to be checked to a level above zero. Only dimmers above zero are checked. <sup>a</sup>	
2. Press [Setup].	Selects Setup display
3. Select [9], <b>ETCLink Functions</b> , and press [Enter].	Selects ETCLink Functions menu
4. Select [4], <b>Load Management</b> , and press [Enter].	Selects Load Management display
5. Press [S4], <b>Load Check</b> . (You may enter specific dimmers to check.)	Prompt reads: <b>To check loads, select dimmer(s) and press ENTER (Enter 0 to check loads for all dimmers)</b>
6. Press [0] [Enter] [Enter].	Advisory reads: <b>All dimmers with levels above zero will have their loads checked. Levels on stage will change while the Load Check is in progress. The system will automatically vary the dimmer outputs during the Load Check. The process may take several minutes to complete.</b>
7. Press [Enter] to proceed with the load check, or press [Clear] to cancel the operation.	Loads are checked for all dimmers with levels above zero Once complete, advisory reads: <b>Load check processing has completed Press [Clear] to continue</b>

*a. If you wish, instead of setting the desired dimmers to a level in step 1, you may enter a list of dimmers to record in step 5.*

---

<sup>6.</sup> *On single phase racks, the system checks 16 dimmers per rack at a time.*

## ***Clear Loads procedure***

Clear Loads allows you to clear recorded loads information for selected dimmers, thus disabling dimmer monitoring for those dimmers. This can be useful if you know that the load on a dimmer or group of dimmers will change over the course of a show and don't want to receive load error messages every time it happens.

To clear recorded loads, follow these steps:

<b>Keystrokes:</b>	<b>Action:</b>
1. Press [Setup].	Selects Setup display
2. Select [9], <b>ETCLink Functions</b> , and press [Enter].	Selects ETCLink Functions menu
3. Select [4], <b>Load Management</b> , and press [Enter].	Selects Load Management display
4. Press [S6], <b>Clear Loads</b> . (If you wish, you may enter a specific dimmer or dimmers to clear.)	Prompt reads: <b>To clear loads, select dimmer(s) and press ENTER (Enter 0 to clear non-zero loads for all dimmers)</b>
5. Press [0] [Enter].	Advisory reads: <b>Recorded loads will be erased for all dimmers with levels above zero, disabling load error messages for those dimmers.</b>  <b>Press [Enter] to proceed, or press [Clear] to cancel</b>
6. Press [Enter] to proceed with the load clear, or press [Clear] to cancel the operation.	Loads are cleared for all dimmers with levels above zero

## Setting and unsetting dimmers

If your console is connected to an ETC Sensor dimming system by an ETCLink network, you may use your console to set and unset dimmers at the dimmer rack.

*Note: For more information on setting dimmers, see the Sensor CEM User Manual.*

### Setting a dimmer

To set a dimmer or group of dimmers to a level at the dimmer rack, ignoring any DMX512 outputs, follow these steps:

<b>Keystrokes:</b>	<b>Action:</b>
1. Press [Setup].	Selects Setup display
2. Press [9], <b>ETCLink Functions</b> , [Enter].	Selects ETCLink Functions menu
3. Press [S7], <b>Set Dimmer</b> .	Prompt reads: <b>Select dimmer number(s) to set, then press ENTER</b> <b>(To cancel, press CLEAR)</b>
4. Enter the dimmers you wish to set and press [Enter].	Prompt reads: <b>Select dimmer level</b> <b>(Press FULL button for 100%)</b>
5. Enter the level at which to set the dimmers. Enter in two-digit form (e.g., one percent = <b>01</b> )	Advisory reads: <b>To confirm, press ENTER</b> <b>To cancel, press CLEAR</b>
6. Press [Enter].	Dimmers are set to desired level

### Unsetting a dimmer

To unset a dimmer (or group of dimmers) and return it to normal operation, follow the procedure below. (**NOTE:** Setting a dimmer to level 00 is not the same as unsetting it and returning it to normal operation.)

<b>Keystrokes:</b>	<b>Action:</b>
1. Press [Setup].	Selects Setup display
2. Press [9], <b>ETCLink Functions</b> , [Enter].	Selects ETCLink Functions menu
3. Press [S6], <b>Unset Dimmer</b> .	Prompt reads: <b>Select dimmer number(s) to unset, then press ENTER</b> <b>(Enter 0 to unset all dimmers)</b>
4. Enter the dimmers you wish to unset and press [Enter]. Press [0] [Enter] to unset all set dimmers.	Prompt reads: <b>To confirm, press ENTER</b> <b>To cancel, press CLEAR</b>
5. Press [Enter].	Dimmers are unset



## Working with Sensor backup looks

A backup look is a recording of a selected look on stage stored in the Sensor CEM. The Sensor system allows you to use either your console or any CEM to bring that look up on stage. You may save and use up to 32 backup looks.

### Recording a backup look

To record a backup look, follow these steps:

<b>Keystrokes:</b>	<b>Action:</b>
1. Use your console to create the desired look on stage.	Creates look on stage
2. Press [Setup].	Selects Setup display
3. Select [9], <b>ETCLink Functions</b> , and press [Enter].	Selects ETCLink Functions menu
4. Press [1], <b>Dimming System Status</b> , [Enter].	Selects System Status display
5. Press [S3], <b>Record Backup</b> .	Prompt reads: <b>Select backup look to record, then press ENTER</b>
6. Enter the backup look number (1-32) and press [Enter].	Advisory reads: <b>Record Backup processing has completed. Press [Clear] to continue.</b>

## ***Playing a backup look***

Playing a backup look brings up the recorded look on stage. You may play back a backup look from the console or from a CEM.

Only one backup look may be on stage at a time. If there is a backup look on stage when you bring up a new one, the second look replaces the first.

Up and down fade times for backup looks are five seconds. They cannot be modified.

To use the console to play a recorded backup look, follow these steps:

### **Keystrokes:**

1. Press [Setup].
2. Select [9], **ETCLink Functions**, and press [Enter].
3. Press [1], **Dimming System Status**, [Enter].
4. Press [S2], **Play Backup**.
5. Enter the backup look number (1-32) and press [Enter].<sup>a</sup>

### **Action:**

- Selects Setup display
- Selects ETCLink Functions menu
- Selects Dimming System Status display
- Prompt reads:  
**Select backup look to play, then press ENTER (Enter 0 to return to normal operation)**
- Advisory reads:  
**Play Backup processing has completed. Press [Clear] to continue.**

- a. *To clear a playing backup look, enter [0] in step 5 as the backup look number. The currently playing backup look will be cleared from the stage.*

# *Chapter 24*

## *Control interfaces*

The console can control and be controlled by a wide variety of external devices. These control interfaces may be as simple as a switch and as complicated as another piece of electronic equipment. They may be timed or asynchronous.

Chapter 24 explains the following interfaces with the console:

- ETC MIDI
- MIDI Show Control
- Real Time Programs
- MIDI time code
- Remote Macros
- Remote Trigger
- Serial Interface

# MIDI

MIDI (Musical Instrument Digital Interface) is a digital communication protocol that allows you to interconnect musical instruments and digital electronic equipment, such as lighting control consoles. The console supports MIDI Show Control 1.0 (MSC) and a subset of MIDI known as ETC MIDI. If you are not familiar with MIDI and would like more information on how it works, *Control Systems for Live Entertainment*, by John Huntington, includes several sections that deal with the subject.

## ETC MIDI

The console both transmits and receives MIDI messages with any MIDI instrument. The MIDI protocol can control cues, macros, submaster bump switches and the level wheel.

ETC assumes that MIDI users have a working knowledge of MIDI. This section provides ETC MIDI interface information, message formats and message definitions. See [Installing MIDI, page 316](#) for installation information.

### Configuring ETC MIDI

The console operates at all times in MIDI Mode 3 or Omni = off/Poly. This means it only receives or transmits MIDI commands on the user-selected channel.

Configure the console for ETC MIDI by specifying the MIDI channel number. Be sure your MIDI gear is set to the same channel. The console remembers the selected MIDI channel the next time it is turned on. The procedure for selecting the MIDI channel is given below:

1. Press [Setup].                      Go to the setup display
2. Press [6] [Enter].                 Selects the Options Settings menu
3. Press [1] [Enter].                 Prompt reads:  
**Select MIDI channel (#1 through 16), or press DISABLE MIDI to disable MIDI**
4. Enter a number between 1 and 16.<sup>a</sup>    Specifies MIDI channel
5. Press [Enter].                      Completes the ETC MIDI setup

a. Press [S1], **Disable MIDI**, here to disable ETC MIDI.

## ***ETC MIDI message formats***

The following table lists MIDI message formats used to control the console. All numbers are in hexadecimal format.

### ***Note off message format***

<8n><kk><vv>  
8 Note off status  
n MIDI channel number (0-F)  
kk Key number (0-7F)  
vv Note off velocity (0-7F)

### ***Note on message format***

<9n><kk><vv>  
9 Note on status  
n MIDI channel number (0-F)  
kk Key number (0-7F)  
vv Note on velocity (0-7F)  
[00=Note off]

### ***Control change message format***

<Bn><kk><vv>  
B Control change status  
n MIDI channel number (0-F)  
kk Control number (70-92)  
vv Control value (0-7F)

### ***Program change message format***

<Cn><kk>  
C Program (patch) change status  
n MIDI channel number (0-F)  
kk Program number (0-7F)

### ***Pitch bend message format***

<En><ll><mm>  
E Pitch bend status  
n MIDI channel number (0-F)  
ll Least significant 7 bits of pitch bend value (0-7F)  
mm Most significant 7 bits of pitch bend value (0-7F)

## **MIDI Message definitions**

### **Submaster bump switch execution**

Submasters 1 - 12	C5 - B5	#60 - #71
Submasters 13 - 24	C6 - B6	#72 - #83

Note: C5 = MIDI note #60 or middle C.

### **Cue execution in AB fader pair**

Next cue	Program change 0
Cues 1 - 127	Program change 1 - 127
Cues 128 - 255	Controller change 70, parameters 0 - 127
Cues 256 - 383	Controller change 71, parameters 0 - 127
Cues 384 - 511	Controller change 72, parameters 0 - 127
Cues 512 - 639	Controller change 73, parameters 0 - 127
Cues 640 - 767	Controller change 74, parameters 0 - 127
Cues 768 - 895	Controller change 75, parameters 0 - 127
Cues 896 - 999	Controller change 76, parameters 0 - 103

### **Cue execution in CD fader pair**

Next cue	Controller change 77, parameter 0
Cues 1 - 127	Controller change 77, parameters 1- 127
Cues 128 - 255	Controller change 78, parameters 0 - 127
Cues 256 - 383	Controller change 79, parameters 0 - 127
Cues 384 - 511	Controller change 80, parameters 0 - 127
Cues 512 - 639	Controller change 81, parameters 0 - 127
Cues 640 - 767	Controller change 82, parameters 0 - 127
Cues 768 - 895	Controller change 83, parameters 0 - 127
Cues 896 - 999	Controller change 84, parameters 0 - 103

### **Macro execution**

Macros 1 - 127	Controller change 85, parameters 1 - 127
Macros 128 - 255	Controller change 86, parameters 0 - 127
Macros 256 - 383	Controller change 87, parameters 0 - 127
Macros 384 - 511	Controller change 88, parameters 0 - 127
Macros 512 - 639	Controller change 89, parameters 0 - 127
Macros 640 - 767	Controller change 90, parameters 0 - 127
Macros 768 - 895	Controller change 91, parameters 0 - 127
Macros 896 - 999	Controller change 92, parameters 0 - 103

### **Level change wheel**

<b><u>Wheel "ticks"</u></b>	<b><u>Pitch bend value (hexadecimal)</u></b>	<b><u>Message values (decimal)</u></b>	
0	2000	ll=0	mm=64
+1	2001	ll=1	mm=64
-1	1FFF	ll=127	mm=63
+8191 (+12.5%)	3FFF	ll=127	mm=127
-8192 (-12.5%)	0	ll=0	mm=0
+655 (+1%)	228F	ll=15	mm=69
-655 (-1%)	1D71	ll=113	mm=58

## ***MIDI Show Control (MSC)***

The consoles recognize the following MSC commands, which may be either transmitted or received (all other commands are ignored):

- Go
- Stop
- Resume
- Fire

### ***Configuring MIDI Show Control***

The console can receive MSC information, send MSC information, or both. Enable the sending and receiving of MSC information by specifying the device(s) that will act as the sender and receiver with respect to the console.

The sending and receiving device numbers are disabled by default. To enable these devices, proceed as follows:

1. Press [Setup]. Go to the setup display
2. Press [6] [Enter]. Selects the Options Settings menu
3. Press [2] [Enter]. Prompt reads:  
**Select MIDI receiver device (#0 - 126), or press DISABLE MIDI to disable MIDI Show Control**
4. Enter a number from 0 to 126.<sup>a</sup> Specifies the number of the device that will send to the console (console is the receiver)
5. Press [Enter]. Prompt reads:  
**Select MIDI transmitter device (#0 - 126), or press DISABLE MIDI to disable MIDI Show Control**
6. Enter a number from 0 to 126.<sup>b</sup> Specifies the number of the device that will transmit the MSC signal
7. Press [Enter]. Completes the setup

- a. If the MIDI receiver device had been previously specified, press [S1], **Disable MIDI**, here to remove that specification.*
- b. If the MIDI transmitter device had been previously specified, press [S1], **Disable MIDI**, here to remove that specification.*

## **MSC commands received by the console**

Consoles enabled for MSC accept the following MSC commands. When the console receives one of these commands, it executes the command immediately. In order to accept MSC commands, the console's receiver **Device ID** must match the target device ID for the MIDI device sending the signals.

<b>Go</b>	<ul style="list-style-type: none"><li>• If no cue number is sent, <b>Go</b> presses [A/B Go] on the console. The next cue on the cue list runs in the A/B fader.</li><li>• If a cue number is sent, the specified cue runs on the A/B fader.</li><li>• If a cue number is sent, and <b>2</b> is sent as the list entry, that cue runs on the C/D fader.</li><li>• If cue <b>0</b> is sent, and <b>2</b> is sent as the list entry, the command presses [C/D Go]. The pending cue runs in the C/D fader. You may also press [A/B Go] by sending <b>Go-Cue 0-1</b>.</li></ul>
<b>Stop</b>	<ul style="list-style-type: none"><li>• The <b>Stop</b> command by itself holds all fades in both fader pairs.</li><li>• If Stop is sent with a cue number and a list entry of 1, only the cue running in the A/B fader holds.</li><li>• If Stop is sent with a cue number and a list entry of 2, only the cue running in the C/D fader holds.</li><li>• The cue number field is ignored, but must be included if a list entry is sent.</li></ul>
<b>Resume</b>	<ul style="list-style-type: none"><li>• The <b>Resume</b> command by itself resumes all holding fades in both fader pairs.</li><li>• If Resume is sent with a cue number and a list entry of 1, only a cue holding in the A/B fader resumes.</li><li>• If Resume is sent with a cue number and a list entry of 2, only the cue holding in the C/D fader resumes.</li><li>• The cue number field is ignored, but must be included if a list entry is sent.</li></ul>
<b>Fire</b>	<ul style="list-style-type: none"><li>• The <b>Fire</b> command executes a specified macro. Macro number must be in the range 1-127. If no macro is specified, or if the macro number is out of range, the command is ignored.</li></ul>



## ***MSC commands transmitted by the console***

MIDI Show Control (MSC) allows the console to send the following commands to MIDI devices. If MSC output is enabled on the console, the console automatically sends the MSC commands. The console's transmitter **Device ID** must match the device ID for the MIDI device receiving the signals.

<b>[A/B Go]</b>	<ul style="list-style-type: none"><li>• If a cue is pending, the console transmits [A/B Go] with cue number and a list entry of 1.</li><li>• If a cue is holding, the console transmits [A/B Resume] with cue number and a list entry of 1.</li></ul>
<b>[C/D Go]</b>	<ul style="list-style-type: none"><li>• If a cue is pending, the console transmits [C/D Go] with cue number and a list entry of 2.</li><li>• If a cue is holding, the console transmits [C/D Resume] with cue number and a list entry of 2.</li></ul>
<b>[A/B Hold]</b>	<ul style="list-style-type: none"><li>• If a cue is running, the console transmits [A/B Stop] with cue number and a list entry of 1.</li></ul>
<b>[C/D Hold]</b>	<ul style="list-style-type: none"><li>• If a cue is running, the console transmits [C/D Stop] with cue number and a list entry of 2.</li></ul>
<b>Macros</b>	<ul style="list-style-type: none"><li>• For macros 1-127, the console transmits <b>Fire</b> with the macro number.</li></ul>

### ***MSC frame packet to run a cue:***

An MSC frame packet consists of several bytes. Byte types, their hexadecimal values and explanations are given in the table below.

<b>Byte type</b>	<b>Value (Hex)</b>	<b>Explanation</b>
Start Byte	<b>F0</b>	Start of System Exclusive Message
	<b>7F</b>	Start of message
Send Channel		Send transmit channel number or 7F = "All Call" for system wide broadcasts
System Exclusive Message	<b>2</b>	Indicates System Exclusive Message is MIDI Show Control
"Lighting" command format	<b>01</b>	User can send 7F = "All Types"
"GO" general command		
Cue number		Cues numbered 0–9 are represented in an MSC frame as hexadecimal 30–39. For decimal cues, the point character is represented by hexadecimal 2E.
Delimiter	<b>00</b>	
Faders	<b>31</b> <b>or</b> <b>32</b>	Console faders are toggled by changing the Cue List number, with fader A/B represented by 31 and fader C/D represented by 32, both hexadecimal.
Delimiter	<b>00</b>	
Stop Byte	<b>F7</b>	End of System Exclusive Message

## **Examples**

In the examples below, MSC frame packets are sent using transmit channel 66 (42 hexadecimal).

### **GO**

Go A/B:            F0 7F 42 02 01 02 30 00 31 00 31 F7  
Go C/D:            F0 7F 42 02 01 01 30 00 32 00 31 F7

### **GO CUE**

Cue1 A/B fader:    F0 7F 42 02 01 01 31 00 31 00 F7  
Cue 5.6 A/B fader: F0 7F 42 02 01 01 35 2E 36 00 31 00 F7  
Cue10 A/B fader:    F0 7F 42 02 01 01 31 30 00 31 00 F7  
Cue350 A/B fader:  F0 7F 42 02 01 01 33 35 30 00 31 00 F7  
Cue1 C/D fader:    F0 7F 42 02 01 01 31 00 32 00 F7  
Cue2 C/D fader:    F0 7F 42 02 01 01 32 00 32 00 F7  
Cue987 C/D fader:  F0 7F 42 02 01 01 39 38 37 00 32 00 F7

### **STOP**

Stop A/B:            F0 7F 42 02 01 02 30 00 31 00 31 F7  
Stop C/D:            F0 7F 42 02 01 02 30 00 32 00 31 F7

### **STOP CUE**

Cue 50 A/B Hold:    F0 7F 42 02 01 02 35 30 00 31 00 F7  
Cue 50 C/D Hold:    F0 7F 42 02 01 02 35 30 00 32 00 F7

### **RESUME**

Resume A/B:         F0 7F 42 02 01 03 30 00 31 00 31 F7  
Resume C/D:         F0 7F 42 02 01 03 30 00 32 00 31 F7

### **RESUME CUE**

Cue 50 A/B Resume: F0 7F 42 02 01 03 35 30 00 31 00 F7  
Cue 50 C/D Resume: F0 7F 42 02 01 03 35 30 00 32 00 F7

### **FIRE\_MACRO** (Macros are limited to 1 - 127)

Macro 3:            F0 7F 42 02 01 07 03 F7  
Macro124            F0 7F 42 02 01 07 7C F7

## Real time programs

The console allows you to create up to 500 real time programs that can run automatically when you're not there. For example, you may wish to turn on the work lights for a choir rehearsal between 7 PM and 9 PM on Monday and Wednesday. Or, warm the filaments of your studio instruments 15 minutes prior to your news program.



These programs run in real time, which means that they execute periodically when pre-set conditions arrive. These conditions include the time of day and either the day of the week or a date. The time settings can be absolute, such as 7:00 a.m., or they can be related to your local sunrise or sunset using the console's astronomical clock feature.

You must do two things before you can properly execute a real time program. First, you must set the real time clock. The procedure for setting the clock is given under [Setting the clock, page 30](#). Second, you must enable real time programs, which is explained in this chapter.

### Go to the Real Time Programs display

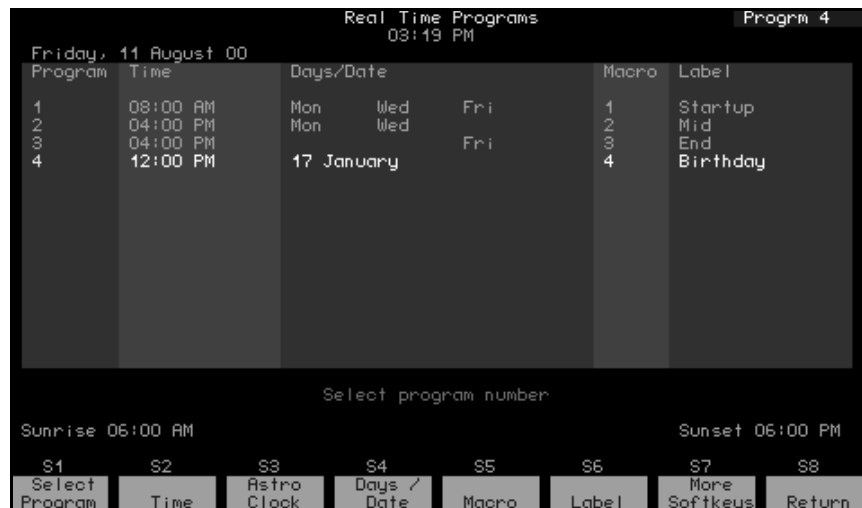
Press [Setup] [1][2], **Real Time Programs**, [Enter] to go to the Real Time Programs display.



Navigation and Feedback - Real Time Programs display					
		[S]			±
Select a program	X	X	X		X
Select a field to edit		X		X	
Select new field data					X
White row	Indicates program selected				
Yellow coloration	Indicates field selected				

## ***Enabling / disabling real time programs***

Real time programs are enabled by default. Follow the procedure below to enable or disable real time programs:

### **Keystrokes:**

1. Press [Setup].
2. Press [6] [Enter].
3. Press [1][1] [Enter].
4. Press [1] [Enter].

### **Action:**

- Selects Setup display mode
- Selects Options Settings menu
- Prompt reads:  
**Enable/Disable real time programs  
 (1 = enable, 0 = disable)**
- Enables Real Time Programs.

## Creating real time programs

You can create a real time program that references either the absolute local time or the astronomical times of sunrise or sunset. Also, you can specify either the days the program will run or a particular date.

### Days and absolute times

Use this procedure when you want to specify days of the week and absolute times. Note in the footnotes to this procedure the substitutions that allow you to specify a date rather than days of the week and sunrise or sunset rather than the absolute time.

Keystrokes:	Action:
1. Press [Setup].	Selects Setup display mode
2. Press [1][2] [Enter].	Selects Real Time Programs display
3. Press [S1], <b>Select Program</b> , [1] [Enter].	Prompt reads: <b>Enter time (12 hour clock)</b> <b>Press [+] to enter AM or PM</b>
4. Press [8][0][0] [Enter]. <sup>a</sup>	Enters time to run macro. Prompt reads: <b>Enter days of week (1=Mon, 2=Tue, 3=Wed, 4=Thu, 5=Fri, 6=Sat, 7=Sun)</b> <b>or press [Days/Date] softkey again for date</b>
5. Press [1] [And] [3] [Thru] [5] [Enter]. <sup>b</sup>	Enters days to run macro Prompt reads: <b>Enter macro number</b>
6. Press [5] [Enter]. <sup>c</sup>	Creates real time program 1 Prompt reads: <b>Type program label (F6 = clear to end, F7 = previous program label, F8 = next program label)</b>

- a. To reference sunrise or sunset rather than absolute time, substitute steps A–C given under [Referencing sunrise or sunset, page 283](#), for step 4 here. Then continue in this procedure.
- b. To reference a date rather than days, substitute steps A–D given under [Referencing a date, page 283](#), for step 5 here. Then continue in this procedure.
- c. Labels are allowed in Express showfiles but cannot be assigned there. To assign labels for Express showfiles, see [Expression Off-Line, page 306](#).

## Referencing sunrise or sunset

To reference sunrise or sunset rather than absolute time, substitute the partial procedure below as explained under [Days and absolute times, page 282](#). This example sets the time to 10 seconds before sunrise.

Keystrokes:	Action:
A. Press [S3], <b>Astro Clock</b> .	Prompt reads: <b>Select astronomical time of day (0 = none, 1 = before sunrise, 2 = after sunrise, 3 = before sunset, 4 = after sunset)</b> .
B. Press [1] [Enter].	Selects before sunrise. Prompt reads: <b>Enter time offset (hours/minutes)</b>
C. Press [1][0] [Enter].	Enters time offset before sunrise when the macro runs Prompt reads: <b>Enter days of week (1=Mon, 2=Tue, 3=Wed, 4=Thu, 5=Fri, 6=Sat, 7=Sun) or press [Days/Date] softkey again for date</b>

## Referencing a date

To specify a date rather than days of the week, substitute the partial procedure below as explained under [Days and absolute times, page 282](#). This example sets the date to 21 March 2000.

Keystrokes:	Action:
A. Press [S4], <b>Days/Date</b> .	Switches to date entry procedure Prompt reads: <b>Enter date (0=all days of month) or press [Days/Date] softkey again for days of week</b>
B. Press [2][1] [Enter].	Selects date=21. Prompt reads: <b>Enter month (#1-12)</b>
C. Press [3] [Enter].	Selects month=3. Prompt reads: <b>Enter last two digits of year or press [Thru] for all years</b>
D. Press [0] [Enter].	Selects year=2000 Prompt reads: <b>Enter macro number</b>

## Editing real time programs

Once you have created a real time program, you can easily make changes to it and others in the Real Time Programs display.<sup>7</sup> Press [↑] or [↓] to move from one program to the next. Press [←], [→] to move through program options. Although you cannot enter the label field in an Express console, you can label Express real time programs using Expression Off-Line. See [Expression Off-Line, page 306](#), for more information.

## Deleting real time programs

You can delete all real time programs as one of the Clear Functions reached from the Setup menu (option 12). Alternatively, you can delete one program at a time in the Real Time Programs display.

Delete a real time program with the following procedure:

Keystrokes:	Action:
1. Press [Setup].	Selects Setup display mode
2. Press [1][2] [Enter].	Selects Real Time Programs display
3. Press [S7], <b>More Softkeys</b> , [S6], <b>Delete Program</b> .	Prompt reads: <b>Select program number(s) to delete, then press ENTER</b> <b>To cancel, press CLEAR</b>
4. Press [5] [And] [6] [Enter].	Selects programs 5 and 6 to delete Prompt reads: <b>To confirm, press ENTER</b> <b>To cancel, press CLEAR</b>
5. Press [Enter].	Deletes programs 5 and 6

## Inserting real time programs

Keystrokes:	Action:
1. Press [Setup].	Selects Setup display mode
2. Press [1][2] [Enter].	Selects Real Time Programs display
3. Press [S7], <b>More Softkeys</b> , [S1], <b>Insert Program</b> , [4] [Enter].	Specify insertion at program 4 Prompt reads: <b>Select program number to insert, then press ENTER</b> <b>To cancel, press CLEAR</b>
4. Press [2] [Enter].	Inserts two new programs starting with number. All following programs are renumbered

---

<sup>7</sup> While editing a real time program, you can run it simultaneously because the editing procedure is buffered in memory. The changes are recorded once you leave the Real Time Programs display and/or sort the programs. See [Sorting/recording real time programs, page 285](#).



## ***Copying real time programs***

<b>Keystrokes:</b>	<b>Action:</b>
1. Press [Setup].	Selects Setup display mode
2. Press [1][2] [Enter].	Selects Real Time Programs display
3. Press [S7], <b>More Softkeys</b> , [S2], <b>Copy Program</b> .	Prompt reads: <b>Select program number(s) to copy, then press ENTER</b> <b>To cancel, press CLEAR</b>
4. Press [1] [Thru] [5] [Enter].	Selects programs 1 through 5 to copy Prompt reads: <b>To copy selected programs(s), select time and press ENTER</b> <b>Press [+] to enter AM or PM</b>
5. Press [7][0][0] [+] [Enter].	Copies program 1 to a new program starting at 7:00 AM; the rest of the programs maintain their original relationship in time

## ***Moving real time programs***

You may move one or more real time programs from one time slot to another. (To move a single program, you may also use the arrow keys to highlight the time for the program you want to move, use the keypad to enter the new time, then press [Enter].)

<b>Keystrokes:</b>	<b>Action:</b>
1. Press [Setup].	Selects Setup display mode
2. Press [1][2] [Enter].	Selects Real Time Programs display
3. Press [S7], <b>More Softkeys</b> , [S3], <b>Move Program</b> .	Prompt reads: <b>Select program number(s) to move, then press ENTER</b> <b>To cancel, press CLEAR</b>
4. Press [1] [Thru] [5] [Enter].	Selects programs 1 through 5 to move Prompt reads: <b>To move selected programs(s), select time and press ENTER</b> <b>Press [+] to enter AM or PM</b>
5. Press [5][0][0] [Enter].	Copies program 1 to a new program starting at 5:00 PM; the rest of the programs maintain their original relationship in time.

## ***Sorting/recording real time programs***

The console simultaneously sorts and records real time programs according to time of day when you exit the display or when you move, copy or delete programs. You can force a sort at any time you are in the display by pressing [S7], **More Softkeys**, [S8], **Sort**.

# Time Code

You can create and run shows that respond to programming based on a standardized time code protocol. The console responds to the Musical Instrument Digital Interface (MIDI) time code.

The console generates an internal time code in the MIDI protocol. The console also can run under external MIDI. You can have both clocks simultaneously enabled so that if ever the external time code signal stopped during a show, the internal clock would immediately take over preserving the continuity of your show.

Shows designed for time code control consist of a series of events that play back at specified times. A time code program also has a modifiable loop time that ranges from 5 seconds to 24 hours. There can be as many as 3,000 time code events, with each event having any combination of cues loaded in faders (one cue for each of two faders), a submaster bump button or a macro.

Up to 32 events may be executed in a single frame.<sup>8</sup> Event times are expressed in hours, minutes and seconds, with each second broken down into frames. For example, 01:25:30:17 is one hour, twenty-five minutes, thirty seconds and seventeen frames. Two frame rates are available in addition to the default rate, which is thirty frames per second.

## Setting time code frame rate

If you are running the time code program from an external clock with internal clock backup, make sure the internal clock has the same frame rate as the external clock. The default frame rate is 30 frames per second, but you can reset it to 24 or 25 frames per second. Reset it as follows:

Keystrokes:	Actions:
1. Press [Setup].	Selects Setup display
2. Press [6], <b>Options Settings</b> , and press [Enter].	Selects Options Settings menu
3. Press [6], <b>Time Code Frames Per Second</b> , [Enter].	Prompt reads: <b>Select Time Code frames per second, then press ENTER (1 = 30 fps, 2 = 25 fps, 3 = 24 fps)</b>
4. Press [2] [Enter].	Time code frame rate is set to 25 fps

---

<sup>8</sup> *If more than 32 events are assigned to the same frame, only the first 32 are executed in that frame, with the rest executing in the following frame or frames until all those assigned are used up. In manual mode, however, only one event is executed when step is pressed, regardless of how many are assigned.*

## Creating a time code program

You can create a time code program in either of two ways: by definition in the Time Code Events display or live after activating Learn Mode in the Time Code Events display. The cues, submasters or macros that you include in time code programs must be pre-recorded.



The screenshot shows the 'Time Code Events' display. At the top, it displays 'TimeCd: 11:34:59:23' and '11:42 AM'. Below this is a table with columns: Event, Time (30fps), A/B, Rate, C/D, Rate, Bump, Rate, Macro, and Label. The table contains five rows of event data. Below the table, there is a red instruction: 'Select Code Time (Press TIME to edit specific fields)'. At the bottom, there is a control panel with eight buttons labeled S1 through S8.

Event	Time (30fps)	A/B	Rate	C/D	Rate	Bump	Rate	Macro	Label
1	00:00:01:00	1		10					Event #1
2	00:01:00:00					16 On	150		Event #2
3	00:10:00:00	2		3		16 Off	150		Event #3
4	00:20:00:00							1	Event #4
5									

Select Code Time  
(Press TIME to edit specific fields)

S1 Internal Clock S2 Clock Disable S3 Manual Mode S4 Pause Mode S5 Step S6 Learn Mode S7 More Softkeys S8 Return

For all procedures in this chapter involving programming in the Time Code Events display, press [Setup] [1][3], **Time Code Events**, [Enter] [Enter] to go to that display. In the display:

- Press [Enter] to advance the cursor across the event line.
- Press horizontal arrows to move to other fields in the event line.
- Press vertical arrows to move up or down to other events.
- Press the right arrow at the end of an event line to move the pointer to the first field of the next event.
- Press the down arrow in the last event to create a new event.

## Creating a program by definition

Use the following procedure to define a time code program in the Time Code Events display. A time code program created in this manner is not recorded until you leave the Time Code Events display, which sorts the program's events as well.<sup>9</sup>

### Keystrokes:

1. Enter [1][0][0] [Enter].
2. Press [1] [Enter].
3. Press [1][2][5] [Enter].<sup>a</sup>
4. Press [Enter].
5. Repeat steps 1 through 4 for fader C/D.
6. Press [1][2] [+] [Enter].<sup>b</sup>
7. Press [Enter].
8. Press [5] [Enter].
9. Press [Enter].
10. Press [2] [Enter]. Enter the number of an event followed by [Enter].

### Actions:

- Selects one second as the time of the first event you want to create  
Prompt reads: **Select A/B Cue**
- Enters cue 1 for event 1 to play on the A/B fader. Prompt reads:  
**Select A/B Rate  
(0 to 2000, 100 = Normal)**
- Enters a rate of 125 percent of the recorded fade rate  
Corner reads:  
**Rate 125**
- Highlight moves to the **C/D** field  
Prompt reads:  
**Select C/D Cue**
- Moves the highlight to the **Bump** field.  
Prompt reads:  
**Select submaster number for bump event, then press [+] for ON, or [-] for OFF**
- Selects submaster 12 and turns the submaster ON. Prompt reads:  
**Select Bump Rate  
(0 to 2000, 100 = normal)**
- Leaves fade rate at normal and moves the highlight to the **Macro** field  
Prompt reads:  
**Select Macro**
- Selects macro 5 to run when event plays. Prompt reads:  
**Enter Label**
- You cannot enter a label from the console but can do so with Expression Off-Line. See [Expression Off-Line, page 306](#), for specific details. Prompt reads:  
**Select event number**
- Selects event 2. Repeat steps above for this and subsequent events

- a. Zero stops the fade; 50 runs the fade at half its recorded rate. If no rate is entered, the cue runs at its recorded rate.*
- b. Entering [+] sets the submaster ON; entering [-] sets the submaster OFF.*

## Creating a program using Learn Mode

Learn Mode allows you to record macro keys, submaster bump buttons and fader [Go] keys into time code events as you go along. Because you are making real-time decisions about the timing of events, you can record a program live in Learn mode without specifying code times. When you leave Learn Mode (press the Learn Mode softkey a second time), the program is recorded with sorted event times.

Follow these steps to record a time code program in Learn mode.

### Keystrokes:

### Actions:

1. Press [S7], until [S6] reads **Learn Mode**.
2. Press [S6], **Learn Mode**. **TimeCd Learn** flashes in red in the upper left corner of the screen
3. If using the internal clock to time the show, press [S2], **Clock Enable**, to start the clock.<sup>a</sup> The internal clock, in the upper right corner of the display, starts to run
4. Go to the Stage display
5. If using an external clock, start it now. You must have time code input enabled as explained under [External time code clock, page 298](#).
6. Select the cues, submasters and macros you want to record as time code events.
7. At the exact moment in the program that you want an event to begin, press [Go] for the fader in which you want the time code event to run the cue, press the submaster's bump button, or start the macro. Each button press is recorded as an event in your time code program
8. Press [Setup] [1][3] [Enter] [S6], **Learn Mode**. Returns to Time Code Events display and deactivates Learn mode; edit the events as necessary

a. After starting the clock, you may press [Record] to enter a blank event.

---

<sup>9.</sup> You can force an immediate sorting the events in the Time Code Events Display. Press [S8], Sort, to sort the events. The sort key is in the third tier of softkeys in this display, so if you don't see it, press [S7], More Softkeys, until it appears at [S8].

## ***Sorting/recording events***

Events are recorded when sorting is done. Sorting is done when you leave the Time Code Events display or you end the time code Learn Mode. You can also force sorting without leaving the Time Code Events display.

A reason for sorting before leaving the Time Code Events display arises when you are playing the program you are currently editing. If the program has not yet come to the place where you made the edits, those edits will be effective on that pass. If, however, the program has already passed the place where you made the edits, those edits will not be effective until the next pass of the program. In some cases, you may want to reset the event list pointer, which is explained below.

To sort, note if your softkeys show Sort at softkey [S8]. If not, press [S7], **More Softkeys**, one or two times until that softkey appears. Then press [S8], **Sort**.

## ***Editing time code programs***

Edit time code programs in the Time Code Events display. While editing a time code program, you can run it simultaneously because the editing procedure is buffered in memory. Your edits, however, may not be effective immediately upon leaving the Time Code Events display because the program is controlled by the events list pointer. If that pointer has already passed an event you edited, the edits don't take effect until the event list pointer is reset to the beginning of the program.

## ***Re-setting the event list pointer***

The event list pointer jumps through time code events regardless of what the time code signal is doing. For example, if the program's next event is 100 frames away, the event list pointer resets immediately to that frame while a steady time code signal moves to it uniformly, frame by frame.

You can interrupt the program by interrupting the time code signal that drives it. If you are using the console's internal clock, you only need to disable that. Likewise, if you are driving the program with an external time code clock, you need only disable the external clock. If using both clocks, you need to interrupt both the internal and the external time code signals to interrupt the program.

Please note that when you disable an external clock while relying on the internal clock for backup, the resynchronization of the clocks cannot occur in less than five seconds after the external signal is restored. Any events scheduled during that resynchronization period will be missed on that pass but will be picked up on the next pass of the program.

If you have been editing the program, the events list pointer may need to be reset. Without leaving the Time Code Event Display and without disabling the clock, you can force the event pointer to reset with the Learn Mode softkey. This works because when you leave Learn Mode by pressing softkey [S6] a second time, you force a resorting of time code events in the program and a reset of the event pointer. There is no need to actually use Learn Mode—just press the Learn Mode softkey twice in succession to do the job.

## Resetting loop time

A time code program loop plays from the first event time to the last event time, then resets and plays again. Any events with code times before the first time or after the last time are ignored. The resettable loop time can run from five seconds to 24 hours.<sup>10</sup>

If you are running a time code program from an external clock, the external clock will control the loop time with its own first event time and last event time settings. To provide synchronized internal clock backup, you must set the first event time and last event time in the Time Code Events display to correspond exactly with those times set for the external clock. Otherwise events might be missed until the two clocks synchronize. It takes at least 5 seconds for external and internal clocks to synchronize.

Use this procedure to set loop times either when running on the internal clock alone or when running from an external clock with internal clock backup.

### Keystrokes:

1. Press [S7] until [S8] reads **Reset Loop**.
2. Press [S8], **Reset Loop**.
3. Press [1][0][0][0].
4. Press [Enter].
5. Press [5][0][0][0] then press [Enter].

### Actions:

Prompt reads:

**Enter first valid frame of internal time, then press ENTER. (Press TIME to edit specific fields)**

Sets ten seconds as the starting time for the time code program

Prompt reads:

**Enter last valid frame of internal time, then press ENTER. (Press TIME to edit specific fields)**

Sets the time code program to reset at the five minute mark

---

<sup>10</sup> If the loop is set to less than five seconds, the internal clock resets it to five seconds from the loop's starting time.

## Deleting time code events

Follow these steps to delete time code events:<sup>11</sup>

Keystrokes:	Actions:
1. Press [S7] until [S6] reads <b>Delete Event.</b>	
2. Press [S6], <b>Delete Event.</b>	Prompt reads: <b>Select event number(s) to delete, then press ENTER To cancel, press CLEAR</b>
3. Press [5] [And] [6] [Enter].	Enters events 5 and 6 to delete Prompt reads: <b>To confirm, press ENTER To cancel, press CLEAR</b>
4. Press [Enter] to delete the event or [Clear] to leave it unchanged.	

## Inserting time code events

Insert a time code event into an existing time code program with this procedure:

Keystrokes:	Actions:
1. Press [S7] until [S1] reads <b>Insert Event.</b>	
2. Press [S1], <b>Insert Event.</b>	Prompt reads: <b>Select event number to insert, then press ENTER To cancel, press CLEAR</b>
3. Press [4] [Enter]. <sup>a</sup>	Prompt reads: <b>Select number of events to insert, then press ENTER To cancel, press CLEAR</b>
4. Press [2].	Indicates that you wish to insert two new events Corner reads: <b>Insert 2</b>
5. Press [Enter].	New events 4 and 5 are inserted; all following events are renumbered

*a. The new event(s) will be inserted before event 4.*

---

<sup>11.</sup> The **Clear Time Code Events** menu option on the Clear Functions menu allows you to delete all recorded time code events. To do so, press [Setup] [4] [Enter] [1][3] [Enter] [Enter].



## ***Copying time code events***

If you are creating a series of similar time code events, you may find it easier to create one event and then copy that as the basis for additional events. Follow the procedure below to copy a selected event or range of events to different code times:

### **Keystrokes:**

1. Press [S7] until [S2] reads  
**Copy Event.**
2. Press [S2], **Copy Event.**
3. Press [1] [Thru] [5] [Enter].
4. Press [Time] [Time] [2][5].
5. Press [Enter].

### **Actions:**

Prompt reads:

**Select event number(s) to copy, then press ENTER. To cancel, press CLEAR**

Selects events 1 through 5 to copy

Prompt reads:

**To copy selected event(s), select time and press ENTER. To cancel, press CLEAR**

Selects 25 seconds for the first event to copy

Copies event 1 to a new event starting at 25 seconds; the rest of the events maintain their original relationship in time

## ***Moving time code events***

Follow this procedure to move a selected event or range of events from one code time to another. The event will move to the new time when you sort the event list or leave the Time Code Events display.

<b>Keystrokes:</b>	<b>Actions:</b>
1. Press [S7] until [S3] reads <b>Move Event</b> .	
2. Press [S3], <b>Move Event</b> .	Prompt reads: <b>Select event number(s) to move, then press ENTER</b> <b>To cancel, press CLEAR</b>
3. Press [1] [Thru] [5] [Enter]. <sup>a</sup>	Selects events 1 through 5 to move Prompt reads: <b>To move selected event(s), select time and press ENTER. To cancel, press CLEAR</b>
4. Press [Time] [Time] [Time] [5].	Selects five minutes for the first event to move
5. Press [Enter].	Copies event 1 to a new event starting at the five minute point; the rest of the events maintain their original relationship in time

*a. To move a single event, you may also use the arrow keys to highlight the code time for the event you want to move, then press [+] or [-] until the new code time is displayed in the keypad prompt window, and press [Enter]. Or, use the keypad to enter the new time, then press [Enter].*

## Editing events

You may add, change or delete events in the Time Code Events display.<sup>12</sup> The changes are effective when you quit the Time Code Event display or press the Learn Mode softkey twice.<sup>13</sup>

Follow the procedure below to edit a time code program:

<b>Keystrokes:</b>	<b>Actions:</b>
1. Use the arrow keys to highlight the field of the item you want to edit.	Selects field to edit
2. Enter the new contents of the field. If you wish to delete the item, press [Clear].	
3. Press [Enter], or use the arrow keys to select another field.	

## Range editing

If you wish to apply a change to a range of events, you may select multiple events and edit them all in a single step. For example, if you wanted to set the rates for your first ten events to 50 percent, proceed as follows:

<b>Keystrokes:</b>	<b>Actions:</b>
1. Press [S7] until [S1] reads <b>Select Event</b> .	
2. Press [S1], <b>Select Event</b> .	Prompt reads: <b>Select event number</b>
3. Press [1] [Thru] [1][0].	
4. Press [S4], <b>Rate</b> . <sup>a</sup>	The first rate field is highlighted Prompt reads: <b>Select A/B Rate</b>
5. Press [5][0].	Sets the rate to 50 percent
6. Repeat steps 6 and 7 for the remaining rate fields.	

*a. Alternatively, you can press other softkeys at this point to edit code time, cue, submaster or macro settings.*

---

<sup>12.</sup> The console does not permit labeling directly. Insert labels or edit in the label field with Expression Off-Line. See [Expression Off-Line, page 306](#), for more information.

<sup>13.</sup> Pressing the Learn Mode key twice is a shortcut way to reset the event list pointer. See [Re-setting the event list pointer, page 290](#), for information.

Or, if you wanted to move ten events five seconds later in a program:

**Keystrokes:**

**Actions:**

- |  |  |
|--|--|
| 1. Press [S7] until [S1] reads<br><b>Select Event.</b> |  |
| 2. Press [S1], <b>Select Event.</b>                    | Prompt reads:<br><b>Select event number</b>  |
| 3. Press [1][1] [Thru] [2][0].                         |  |
| 4. Press [S2], <b>Code Time.</b>                       | The time field is highlighted<br>Prompt reads:<br><b>Select Code Time (Press TIME to edit specific fields)</b> |
| 5. Press [Time] [Time].                                | Selects the seconds field for all ten events<br>Prompt reads:<br><b>Select seconds</b>                         |
| 6. Press [+] five times.                               | Each time you press [+], the seconds field for each event increases by one second                              |
| 7. Press [Enter].                                      | Sets the new times   |

## Running a time code program

You can run a time code program in three ways: using the console's internal time code clock, using an external time code clock or manually.<sup>14</sup> When using the external time code source, the internal clock serves as a back up to continue the program if the external clock fails.

### Internal time code clock

Follow this procedure to run a time code program using the console's time code clock:

#### Keystrokes:

1. Press [S1], **Internal Clock**.
2. Use the keypad or the [+] and [-] keys to enter the code time of the first event you want to view, or enter zero to start at the beginning of the time code program.
3. Press [Enter].
4. Press [S2], **Clock Enable**, to start the internal clock running at the desired code time.<sup>a</sup>

#### Actions:

Prompt reads:  
**Set internal clock, then press ENTER (Press TIME to edit specific fields)**

Each time code event will run at its recorded time

- a. *This softkey toggles between Clock Enable and Clock Disable. A disabled clock is indicated by the message Clock Disabled in the upper left corner of the display and an unchanging **TimeCd** value. When the clock is enabled and runs, the **TimeCd** value runs up.*

---

<sup>14.</sup> *As you play a time code program, you may find it useful to include the Time Code List in the Stage and Blind displays. Display the Time Code List by pressing [Setup] [6] [Enter] [7] [Enter] [1] [Enter].*

## External time code clock

When running a real time program with an external clock, the event list pointer jumps to agree with the frame of the external clock. Sometimes the timing signal is not yet present even though the external clock is enabled, causing a delay in the execution of the program. When that happens, you will see a **Waiting for input** message at the upper left corner of the Time Code Events display. When the external signal begins, the message disappears and the **TimeCd** value begins to run.<sup>15</sup>

You can lose events on the first pass through the program if the external signal starts before the program is ready.<sup>16</sup> That happens because the event list pointer moves with the external signal and has already passed the code time of one or more events. These missed events, however, will be played in subsequent passes through the program.

Enable an external clock with the procedure below. Note that the procedure also enables the console's internal clock, which can then provide backup if the external clock signal fails. The order in which these two clocks is enabled is important. Also note that it takes at least five seconds for the external and internal clocks to come into synchronization, so any events during that initial synchronization period could be missed.

Keystrokes:	Actions:
1. Press [Setup].	Selects Setup display
2. Press [6], <b>Options Settings</b> , and press [Enter].	Selects Options Settings menu
3. Press [5], <b>Time Code Input</b> , [Enter].	Prompt reads: <b>Enable/disable external time code input</b> <b>0=Disable, 1 = Enable MIDI Time Code (MTC)</b>
4. Press [1] [Enter].	Enables the external MIDI time code clock
5. Press [S8], Return.	Returns to the Setup display
6. Press [1][3] [Enter].	Selects the Time Code Events option
7. Press [S2], <b>Enable Clock</b> .	Enables the internal time code clock

---

<sup>15.</sup> You can verify which clock is running the program by the color of the **Timecd** number in the upper left corner. A red number means the internal clock is running the program; a green number means that the external clock is running the program.

<sup>16.</sup> Losing events on the first pass can also happen if you edit a program that is running at the same time. To avoid that, see [Re-setting the event list pointer, page 290](#).

## Manual playback

The [Manual Mode], [Pause Mode], and [Step] softkeys allow you to manually control playback of time code events without a time code source enabled. Press [Time] to select an event out-of-sequence by specifying its code time. Use either the Manual Mode or Pause Mode softkeys to ensure that neither an internal nor an external time code clock can run events while you are creating or editing a time code program.

### Keystrokes:

1. Press [S3], **Manual Mode**  
or...  
Press [S4], **Pause Mode**.
2. Press [S5], **Step**.<sup>a</sup>
3. Repeat step 4 to advance sequentially through time code events.
4. If you are in Manual mode, press [S3], **Manual Mode**.  
If you are in Pause mode, press [S4], **Pause Mode**.

### Actions:

- Stops the time code input and resets the console to the first recorded time code event,  
or...  
Interrupts time code input at the current time code event
- Advances to the next recorded time code event,
- Returns to normal operation and the time code resumes

*a. In Manual mode, pressing [Step] starts with the first recorded time code event and proceeds in recorded order. Only one event is executed each time you press [Step].*

## ***Remote macros***

The remote macro feature provides the ability to control up to 4 console macros from locations up to 1,000 feet away. Typically the Remote Macro control device is a four button control station.

The remote macro terminals on the console rear panel control macros 1,901 through 1,904. To operate one of these console macros from a remote location, press the appropriate control.

ETC does not provide remote macro control units. However, the console does provide a 15-pin connector labeled **Remote Macro** to which you may attach a user-supplied, remote macro control device. See [Installing remote macros, page 317](#) for more information about connecting a remote macro controller to your console.

## ***Serial interface***

Please disregard option 13, Serial Protocol Baud Rate, on the Options Settings menu as well as the associated softkey in that menu, [S2], **ESP Baud Rate**. Those choices are intended for the Express Lighting Playback Controller which has a RS232 serial interface port that is reserved for future implementation.



## Remote trigger

The remote trigger function allows you to program a macro to send an On or Off signal to any external device that responds to a remote contact closure. This signal can control any external event (for example, a sound machine or a bubble machine).

To create a simple remote trigger macro, follow these steps:

<b>Keystrokes:</b>	<b>Action:</b>
1. Press [Setup].	Selects Setup display screen
2. Select 8, <b>Macro Editing</b> , and press [Enter].	Selects Macro display screen Prompt reads: <b>Select macro number, then press ENTER</b>
3. Press [1][0] [Enter].	Macro 10 created Prompt reads: <b>Select operation(s) for this macro – press ENTER MACRO when done (Wheels and sliders are not valid entries in macros)</b>
4. Press [S7] <b>More Softkeys</b> , [S3], <b>On Trigger</b> .	Enters an On Trigger command Macro contents line reads: <b>OnTrigger</b>
5. Press [S8], Macro Wait, [5] [Enter].	Enters a macro wait of 5 seconds Macro contents line reads: <b>OnTrigger Mwait-5</b>
6. Press [S4], Off Trigger.	Enters an Off Trigger command Macro contents line reads: <b>OnTrigger Mwait-5 OffTrigger</b>
7. Press [Enter Macro].	Saves macro. Macro 10 sends an On Trigger command, waits five seconds, then sends an Off Trigger command



# ***Chapter 25***

## ***Accessories***

Chapter 25 provides information about the following lighting system accessories:

- Remote Focus Unit (RFU)
- Alphanumeric keyboard
- Console lights
- Expression Off-Line

For accessory installation instructions, see [Appendix A Installation, page 307](#). For purchase information, please contact your local dealer or ETC.

# Remote Focus Unit (RFU)

The Remote Focus Unit (RFU) is a small, portable control panel you can use from a remote location, such as in the house, on your studio set or from backstage, with or without a remote monitor. You can control most console functions (not submasters) with an RFU. The console keypad and RFU are able to operate simultaneously. Changes made from both console and RFU are displayed immediately on both the console monitor and the RFU.

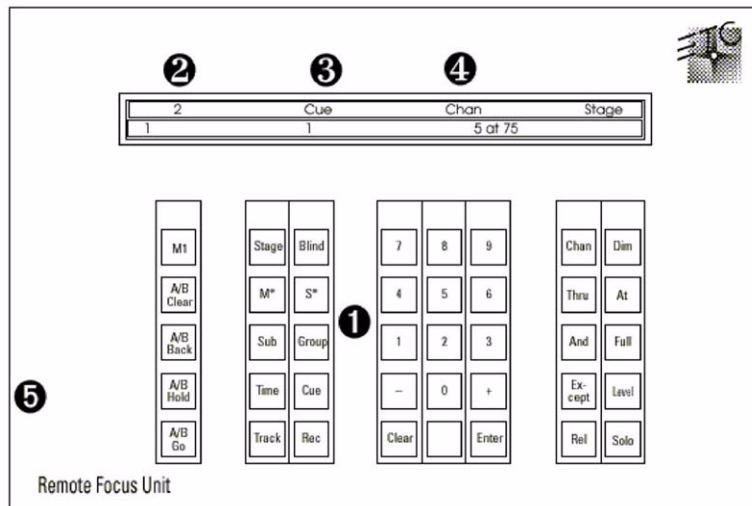

## ❶ Keypad

The keys on the RFU's keypad function exactly like their counterparts on the console.

## ❷ Fader window

The top line displays the next cue on the cue list. The bottom line displays the cue in the A/B fader on the left and the cue in the C/D fader on the right.

## ❸ Cue/channel number window

Displays the currently selected cue, group or submaster

## ❹ Keypad prompt window

Displays the same prompt that appears in the upper right corner of the Stage or Blind display.

## ❺ Power switch

Power is **ON** in the up position and **OFF** in the down position. To operate your installed RFU, move power switch to **ON**. **WARNING:** Do not connect or disconnect the RFU when it is turned on.

For RFU installation instructions see [Installing Remote Focus Unit, page 315](#). For instruction on installing a remote monitor, see [Installing remote video monitors, page 325](#).

# Alphanumeric keyboard

The Express console does not support an alphanumeric keyboard. However, if you have either a Remote Interface Unit or a Remote Video Interface unit attached to your console, you can attach an alphanumeric keyboard to that peripheral device and achieve the same results.<sup>17</sup>

The keyboard's function is to allow you to assign labels (also called names) to your show and to elements of it, including cues, submasters, groups, channels, dimmers, time code events and fixtures. Names may have up to 16 characters, composed of letters, numbers or the symbols **#, %, &, \*, (, ), +, ', -, [, ], /** as well as the comma and period.

## Labeling procedure

1. Go to the display in which you want to create a label. For example, go to [Stage] or [Blind] to label cues, submasters, groups or focus points. Go to the Time Code Events display to label an event.
2. At the console, select the item to label. For example, if you want to label cue 5, press [Cue] [5] [Enter] to make the selection.
3. Press [F5] on the keyboard to enter label mode. When in label mode, a blue band appears at the upper right corner of the monitor containing a prefix, such as **Label**, and a blinking cursor.
4. Type the desired label on the alphanumeric keyboard. You may use the [Home], [End] and [Insert] keys on the keyboard when entering a label. Home and End allow you to move directly to the beginning or end of the name, respectively. Insert is a toggle that allows you to choose between overwriting or inserting text. You may also use [F6] to clear the label from the point of the cursor to the end of the line.
5. Press [Enter] on the alphanumeric keyboard to record the label, or press [Esc] to quit and return to the original console display screen.
6. Press [F8] on the alphanumeric keyboard to advance to the next selection, such as the next cue, submaster or group. Press [F7] to go to the previous selection.

## Shows

To name a show, press [Setup], and use steps 3-5 of the *Labeling Procedure* above to enter the show's name.

---

<sup>17</sup>. See *Installing an alphanumeric keyboard, page 314*, for installation information.

## ***Console lights***

Express provides two 3-pin female XLR type connectors at the top rear of the console for the attachment of optional Littlite gooseneck console lights. Littlites come in 6-inch (6X-HI), 12-inch (12X-HI), and 18-inch (18X-HI) lengths. They are available from ETC or from your dealer.

**CAUTION:** Use of any other brand but Littlites is not recommended by ETC. The results may be unexpected.

After installing control lights, adjust light intensity with the knob located above the power switch on the console's rear panel.

The lamps provide a 5 watt, high intensity light source, operating at 12 volts AC or DC and 380 mA. Lamp life is rated at 12 volts and will decrease with higher voltage operation.

## ***Expression Off-Line***

When you want to create or modify a program but are not near your console, consider working off-line with Expression Off-Line. This handy program runs on a pc computer and emulates the function of Express consoles running version 3.03 system software.

With Expression Off-Line, you can do everything in the computer you could do at your console keyboard except run a show. When the show you produce in Expression Off-Line is ready, merely store it on a diskette, transfer the diskette to your console, read it and run it. Or, if you want to modify a show stored in the console, you can do it in Expression Off-line as well and free the console for other purposes.

One advantage of using Expression Off-Line is that you can print lists from your show without attaching a printer to the console. Another special benefit for Express users is that you can label show elements, such as dimmers, cues and the show itself, and the labels appear with the show when you run it in the console. Type the keyboard equivalent "B" in Expression Off-Line whenever you are in a display that allows labeling, such as in cue and spreadsheet lists or the Real Time Programs display.

Expression Off-Line is available without charge from ETC. It can be ordered through your dealer or directly from ETC at 800-775-4382. You can also download Expression Off-Line from the ETC website at [www.etcconnect.com](http://www.etcconnect.com).

# *Appendix A*

## *Installation*

This appendix includes instructions for installing your console and optional accessories. [Chapter 3 System settings](#) and [Chapter 4 Patching channels](#) include instructions for entering the software settings you will probably update before you begin a new show.

Appendix A includes the following installation procedures:

- Installing your console
- Installing your monitor
- Connecting your dimmers
- System configuration
- Installing the alphanumeric keyboard
- Installing a printer
- Installing Remote Focus Unit
- MIDI
- ETCNet
- Installing remote video monitors
- Installing Remote Macros
- Installing console lights

An illustration of the console's back panel is shown on the next page. Operating instructions for optional accessories are included in [Chapter 25 Accessories, page 303](#).

## Console's back panel

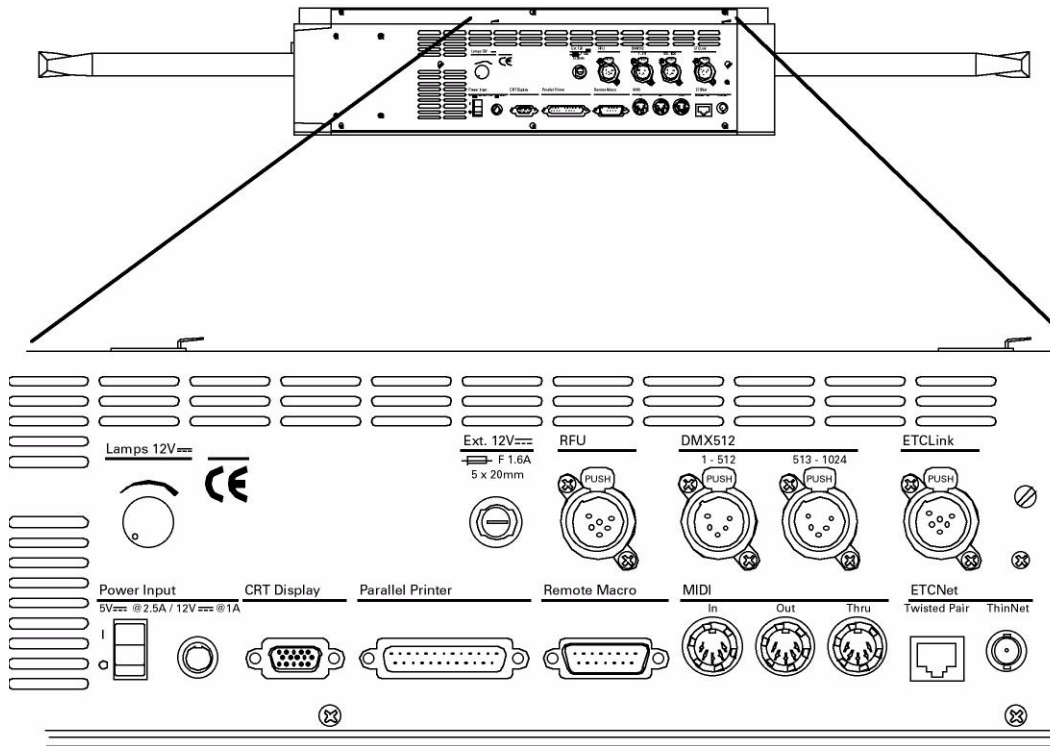

### External device fuse

If you have an external device such as console lights, an RFU or a remote macro controller connected to the console and it doesn't operate, check the External 12V fuse. This fuse is located in a pop-out receptacle located next to the RFU port.

1. Turn off the console.
2. Remove the power cord.
3. Remove the cover of the fuse receptacle with a flat blade screwdriver.
4. Remove and examine the fuse. Telltale signs of a blown fuse include discoloration or deposits on the glass envelope and/or a visibly broken fuse strip.
5. If you find a blown fuse, replace it with the fuse of the same size and type.
6. With a good fuse installed, reinsert the fuse into the rear panel holder and secure with the screwdriver.
7. Verify that the external device works properly. If still having problems, see [Help from ETC Technical Services, page 11](#), to get help from ETC.



## ***Installing the console and monitor***

Follow these steps to install the console and its monitor:

1. Place console on a hard, stable, flat surface. Leave at least six inches of space behind console for ventilation and cable clearance. Console should be at least six feet from dimmers and high-current AC lines.  
**CAUTION:** *Do not leave the console in a road case tray or on a soft surface. This will inhibit proper ventilation.*
2. Move console power switch (by fan on back panel) to the **Off** position.
3. Connect the video cable from the monitor to the console connector labeled **CRT Display** on the back panel.
4. Insert the female end of the console power cord into the connector on the power supply. Insert the round 6-pin connector on the power supply cord into the connector labeled **Power Input** on the console's back panel.
5. Insert the female end of the monitor power cord into the connector on the back of the monitor.
6. Insert the male end of the monitor power cord into a grounded power outlet.
7. Insert the male end of the console power cord into a grounded power outlet.

### ***VGA monitor connections***

#### ***Connector***

HD-DB15 female

#### ***VGA monitor pinout***

- 1 Red video
- 2 Green video
- 3 Blue video
- 4 Ground
- 5 Ground
- 6 Red ground
- 7 Green ground
- 8 Blue ground
- 9 not connected
- 10 Ground
- 11 Ground
- 12 not connected
- 13 Horizontal (H/V) sync
- 14 Vertical sync
- 15 not connected

*Note: In some installations you may need additional grounding. An additional grounding location is provided on the rear of the console for this purpose. This console is not certified for use in wet locations.*

## ***Understanding ETCNet***

The console is capable of operating with other devices in local area networks. ETC has two such networks, ETCNet and ETCNet2, and both operate using Ethernet protocols. None of the Expression-family consoles are capable of operating directly on ETCNet2. One exception is through the use of a ETCNet2 DMX Node as a DMX-to-ETCNet2 converter, but this network configuration will not be discussed in this User Manual.

When operating on ETCNet, any network interface device connected to the network mimics the output of the console. Your network devices can be the older-style Remote Interface Unit (RIU) devices or Remote Video Interface (RVI) devices. Or, they may be ETC's newest remote interface devices, including the ETCNet2 DMX Node and the ETCNet2 Video Node. You can mix and match old and new interface devices in your network. Only the newer nodes are capable of operating on ETCNet2.

### ***Installing interface devices***

To install RIU or RVI devices, follow the instructions given in the Reference appendix of this manual. To install an ETCNet2 node, see the separate Installation Guide for that device.

### ***Network wiring***

Your console may be connected to the network using either thinnet (BNC) or twisted pair (RJ45) wiring. If you are connecting your console directly to an ETCNet2 interface device, you must use twisted pair wiring. If you use more than one remote interface device, you must use a hub. If the hub has thinnet ports, you can connect the console and older interface devices to the hub using either twisted pair or thinnet, but you must use twisted pair when connecting any ETCNet2 interfaces to the network. If your network operates with twisted pair wiring, it may be necessary to change your twisted pair polarity. Press [Setup] [6] [Enter] [1][2] [Enter] to select the polarity. If you are using a hub, set the polarity to **Not Swapped**. Otherwise, set the polarity to **Swapped**.

### ***Preparing interface devices***

Every device operating on your ETC network must be running the same system software. If you have a new system, most likely the software installed in each device is compatible with all the others. But different versions of software can exist in different devices because of software upgrades that occurred while the device was being manufactured. You should make sure.

To verify the software running on your interface devices and upgrade it if necessary, go to the Remote Unit Upgrade Program display. You reach this display using the Remote Interface diskette supplied with your system or in a system software upgrade kit. Follow the procedure given under [Upgrading remote interface devices, page 319](#).

## ***Connecting dimmers to console***

These instructions explain how to connect DMX512 outputs and provide DMX512 connector pinout specifications. The console provides two DMX512 output ports for a total capacity of 1,024 outputs.

Follow these steps to connect dimmers to your console:

1. Verify that your dimmer connector pinout matches the pinout listed below. If your pinout does not match, contact your dealer or ETC.

*Caution: Your dimmer control common must be compatible with console control common; they must either be the same level, or the dimmer control common must float. Verify compatibility with your dealer if you are not sure.*

2. Connect up to two DMX512 cables to DMX512 output connectors on the console's back panel (shown under [Console's back panel, page 308](#)).

### ***DMX512 connector***

XLR 5-pin female  
512 digital multiplex dimmers

### ***DMX512 pinout***

- 1 Common
- 2 Data (-)
- 3 Data (+)
- 4 not connected
- 5 not connected

## Configuring the DMX512 ports

Once your console is installed, you may need to reset some hardware configuration settings. The Output Configuration screen allows you to reset the starting dimmer numbers for your DMX512 ports, set your ports for dimmer doubling and adjust the DMX512 signal speed if your dimming system requires a slower signal.



### Port starting dimmer numbers

Each port has a starting dimmer number which can be reset in the Output Configuration display. Shown above are the default starting dimmer numbers for Express consoles.

Unless using dimmer doubling,<sup>1</sup> you might want to set different starting numbers, such as when default port settings would result in some racks being connected to two ports. For example, if your system included 10 racks, each with 96 dimmers, you could set port 2 to start at **481**.

Set port starting numbers in the Output Configuration screen as follows:

1. Press [Setup] to display the Setup Menu.
2. Press [2], **Output Configuration**, and press [Enter].
3. Press [↓] to select the port to configure (port 1 or 2).
4. Press [S3], **Starting Dimmer**.
5. Enter the desired starting number for the port.
6. Press [Enter] twice to confirm your choice.

---

<sup>1</sup> You cannot change starting dimmer numbers when using Dimmer Doubling. See [Setting the port to Dimmer Doubling, page 313](#).

## Setting the port to Dimmer Doubling

If your console is controlling an ETC Sensor dimming system that can operate in Dimmer Doubling mode, each dimmer and the port to which the dimmer is connected must be individually set to support that feature. Moving light fixtures cannot be patched to a doubled port.

**WARNING:** Set the port mode using the procedure below *BEFORE* you create your patch. Changing a port to or from Dimmer Doubler mode unpatches all conventional lights and moving light fixtures controlled by that port.

Use the following procedure to set a port's mode to double. Use the procedure given under [Setting dimmers to Dimmer Doubling, page 48](#), to set the mode of individual dimmers to double.

1. Press [Setup] to display the Setup Menu.
2. Press [2], **Output Configuration**, and press [Enter].
3. Press [S1], **DMX512 Port**, enter the port to configure (port 1 or 2). You may also use [↓] to select a port.
4. Press [Enter].
5. Press [1] to set the port for Dimmer Double mode or [0] to set the port for Normal mode.
6. Press [Enter] twice to confirm your choice.
7. Display identifies mode as either **Normal** or **Double**.

## Setting DMX512 speed

If your console is controlling a dimming system that requires a slower DMX512 signal, specify this in the Output Configuration screen

The console is designed to run at the highest rate provided for in DMX512 specifications. Some dimming systems (including some Colortran ENR™ dimmers) may require a signal slower than the full DMX512 specification. If this proves necessary, you may reset the console's signal speed.

Speed choices are **Slow**, **Medium**, **Fast**, and **Max**. When installed, the console defaults to **Max**. If you have problems with outputs flashing, fades not running smoothly, or unselected dimmers rising spontaneously, experiment with slower speeds until the symptoms disappear. If the symptoms persist, please call ETC Technical Services at 800-775-4382.

To reset the DMX512 signal speed, follow these steps:

1. Press [Setup] to display the Setup Menu.
2. Select 2, **Output Configuration**, and press [Enter].
3. Press [S4], **DMX512 Speed**.
4. Press [0] for **Max**, [1] for **Fast**, [2] for **Medium**, or [3] for **Slow**. The speed you choose appears in the upper right corner of the display.
5. Press [Enter] to confirm your choice. The display shows the speed setting.

## ***Installing an alphanumeric keyboard***

Although your console does not support an alphanumeric keyboard, you can connect a keyboard to a Remote Interface Unit or Remote Video Interface. Use the optional keyboard to assign labels to many features of your shows, such as to name the show and the cues, submasters, groups, timed events and programs within it.

You can supply your own keyboard or order one from ETC. If you supply your own, it must be an AT compatible type or switchable to an AT-compatible mode. ETC recommends the Cherry G80-1800 and Keytronic 101 keyboards. Although you may use keyboards from other manufacturers, ETC does not guarantee compatibility.

**CAUTION:** *Do not connect or disconnect an alphanumeric keyboard while your system is turned on. Doing so may cause the keyboard to initialize improperly.*

Follow these steps to install an alphanumeric keyboard:

1. Be sure the selector switch is set to the AT position, if applicable.
2. Insert the keyboard cable into the connector labeled **Keyboard** on the remote interface unit.

### ***Console connector***

DIN 5-pin female

### ***Keyboard pinout***

- 1 Clock
- 2 Data
- 3 Reset
- 4 Ground
- 5 +5 Vdc

## Installing a printer

The console supports parallel printers, including most laser printers. Printer functions are described in [Chapter 21 Printing, page 249](#). Follow these steps to install the printer:

1. Insert the parallel printer cable into the connector labeled **Parallel Printer** on the back panel of the console.
2. Insert the opposite end of printer cable into printer.
3. Turn printer power switch on, and verify that printer is on line.

<b>Console connector</b>		<b>Printer connector</b>
DB25F	Centronics D36	
<b>Pinout</b>	<b>Signal</b>	<b>Pinout</b>
1	STRB	1
2	D0	2
3	D1	3
4	D2	4
5	D3	5
6	D4	6
7	D5	7
8	D6	8
9	D7	9
10	ACK	10
11	Busy	11
12, 13	Not used	12, 18
14 to 17	not connected	13 to 15, 17, 19 to 36
18 to 25	Ground	16

## Installing Remote Focus Unit

The Remote Focus Unit (RFU) allows you to set channel levels, check dimmers or run cues from remote locations.

To install the RFU, follow these steps:

1. Verify that RFU power switch is turned **Off**. (Unit is off when switch is in the position toward the bottom edge of the RFU.)
2. Insert the RFU cable into the connector on the back of the console or Remote Interface labeled, **RFU**.
3. Turn RFU power switch to **On**.

### **RFU console connector**

XLR 6-pin female

### **RFU pinout**

- 1 Data (+) (to RFU)
- 2 Data (-)
- 3 Data (+) (from RFU)
- 4 Data (-)
- 5 Common (AC ground)
- 6 +12 Vdc (fused, 2 amp)

## ***Installing MIDI***

Connect the console to any MIDI equipment using a standard MIDI cable.

There are three round, 5-pin, DIN-type connectors labeled **MIDI In**, **MIDI Out**, and **MIDI Thru** on the back of the console. Turn console power off, then connect the cable from the **MIDI Out** of the electronic instrument or sequencer to the **MIDI In** on the console. Connect the cable from the **MIDI In** on the instrument or sequencer to the connector labeled **MIDI Out**.

Follow these steps to connect MIDI equipment to the console:

1. Turn console power off.
2. Insert standard MIDI cable into the connector on the back of the console labeled **MIDI In**. 3. If you are sending MIDI commands from the console, insert another standard MIDI cable into the connector on the back of the console labeled **MIDI Out**.

### ***MIDI console connectors***

DIN 5 pin female

### ***MIDI pinout***

- |   |               |
|---|---------------|
| 1 | not connected |
| 2 | Ground        |
| 3 | not connected |
| 4 | MIDI +        |
| 5 | MIDI –        |

## ***Installing console lights***

Plug the two Littlites into the connectors at the top rear of the console. Bend the gooseneck of each to suit your needs.

**CAUTION:** Use of any other brand but Littlites is not recommended by ETC. The results may be unexpected.

### ***Connectors***

XLR 3 pin female

### ***Pinout for Littlites***

- |    |                |
|----|----------------|
| 1  | Chassis ground |
| 2  | Dimming leg    |
| 3. | + 12 Vdc       |

Connect the light between pins 2 and 3.



## ***Installing remote macros***

The console provides four remote macro inputs through the 15-pin connector on the back panel labeled **Remote Macro**. A user-supplied remote device connects to the console via a 24 AWG, aluminum-shielded, multi-conductor cable with one twisted pair designated for each switch (Belden 9507 S-R PCV Insulated or Alpha 5477 80 Deg. C 300 V PVC). The cable connector at the remote device will vary depending on the device itself.

### ***Console connector***

DB-15 female

### ***Remote connector***

Connector type depends on unit

<b><i>Pin</i></b>	<b><i>Function</i></b>
1	+Macro 1,901
2	-Macro 1,901
3	+Macro 1,902
4	-Macro 1,902
5	+Macro 1,903
6	-Macro 1,903
7	+Macro 1,904
8	-Macro 1,904
9	Remote Trigger - normally closed (30V 1 amp max)
10	Remote Trigger - normally open (30V 1 amp max)
11	Remote Trigger - common (30V 1 amp max)
12	Ground
13	Ground
14	+ 12 Vdc fused
15	+ 12 Vdc fused

## Wiring remote macros

There are three typical ways to wire the **Remote Go** function:

1. Connect all -Macro pins (pins 2, 4, 6, and 8) to ground (pins 12 and 13) and switch the leads connecting the +Macro pins (pins 1, 3, 5, and 7) to +12 Vdc (pins 14 and 15) as shown in the following diagram.

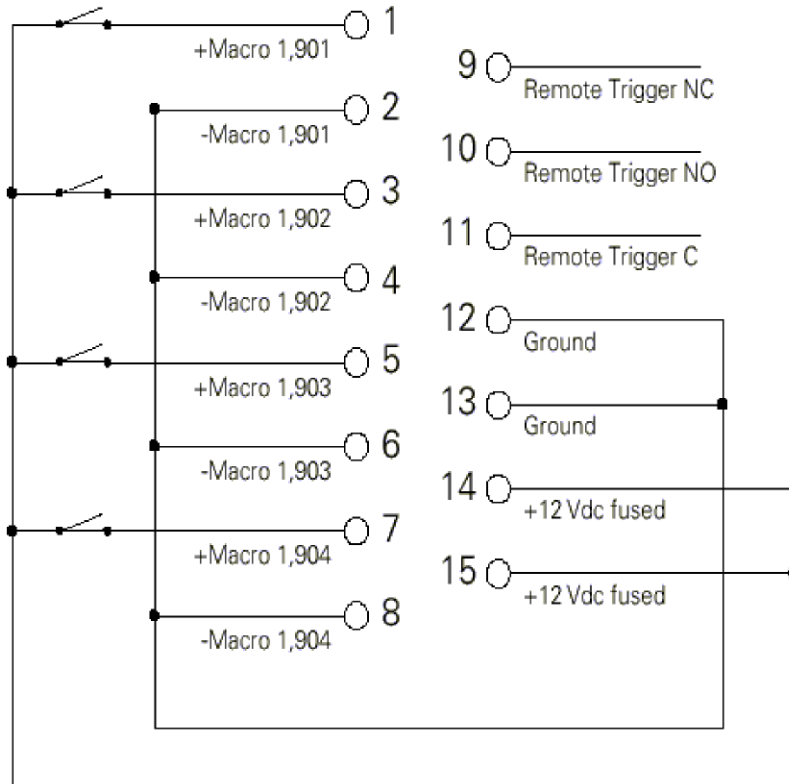

2. Connect all +Macro pins (pins 1, 3, 5, and 7) to the +12 Vdc pin (pins 14 and 15) and switch the leads connecting the -Macro pins (pins 2, 4, 6, and 8) to the ground (pins 12 and 13).
3. Provide your own power supply that generates a 12 Vdc potential between the +Macro and -Macro pins and switch either of these leads.

# Upgrading software

## Upgrading a console

**NOTE:** If upgrading system software in a lighting playback controller (LPC), some of the steps below are slightly different because LPC controls are different. See your LPC QuickGuide for information about these differences.

Express software upgrades are distributed in kits that contain one or more upgrade diskettes and usually an installation document. Follow these kit instructions when provided. When upgrading, make sure the diskette you use is marked for your console.

1. Installing new console software clears all system memory. Please save your current show!
2. Turn the console off.
3. Insert the console software diskette into your console's diskette drive.
4. Turn the console back on. The console displays the boot screen and automatically installs the software. This process takes approximately one minute. The console displays the following messages as the installation progresses: **Loading, Erasing Flash, Writing Flash**. Wait until the Stage display appears.
5. Press [Setup] to confirm that the new software has been successfully installed. The current software version is displayed in the lower right corner of the display. This version number should match the number on the diskette. If it does not, repeat the procedure.
6. Press [4] [Enter] [S1], **Reset System**, [Enter] to complete the upgrade.
7. Remove the diskette from the disk drive and store.

## Upgrading remote interface devices

If your console is connected through ETCNet to one or more remote units, you need to upgrade the system software in those units whenever you upgrade the console software. The reason is that every device operating on an ETC network must be using the same version of software.

If your network contains any of ETCNet2 nodes, you might need to set the network status before downloading the code. The reason is that these nodes can operate using either of two ETC local area protocols, ETCNet or ETCNet2, but Expression-family systems must use ETCNet. Setting the network configuration is covered in one of the following sections.

### Remote Unit Upgrade Program display

Verify and upgrade the software operating in remote interface devices in the Remote Unit Upgrade Program display. Enter that display as follows:

1. Save your current show. Installing a new version of software will **not** clear system memory, but it is always best to be cautious.
2. Turn off the console.
3. Turn on all remote interface devices.
4. Insert the Remote Unit Upgrade diskette into your console's diskette drive.
5. Turn the console back on. The console will display a boot screen with a loading counter. When the count reaches 100%, the Remote Unit Update Program display appears.

### **Characteristics of the display**

The display contains the following three elements: (1) the title line, (2) an inventory of network devices, and (3) the Remote Units list. The title line names the display and identifies the version of code on the diskette you used to bring up the display (the upgrade diskette). The device inventory, located below the title line, identifies all possible ETC network interface devices by type, version number and CRC number. For a device in your network to be compatible with the code on the upgrade diskette, both the version number and the CRC number must match.

Your console will detect remote interface devices operating on your network by listing them in the Remote Units list. From this list, you can make the following determinations.

- Are any interface devices in your network not showing up in the list?
- Does every device in your network display a software version that matches the version for that type in the device inventory?
- Does every device in your list display a CRC number that matches the CRC number for that type in the device inventory?

### **Devices missing from the Remote Units list**

There can be several problems preventing an interface device from showing up on the Remote Units list, most of which are easily correctable. First of all, verify power to a missing device as well as to the hub to which it is connected, if any. Second, verify all network connections along the network route along between the console and the missing device. If your network uses twisted pair wiring, press [S6], **Swap Twst Pair**, and wait ten seconds. If a missing device is an ETCNet2 node, set the protocol to ETCNet by pressing [S5], **Discover Nodes**, and wait ten seconds. If all efforts fail, see [Help from ETC Technical Services, page 11](#), for information about getting technical assistance.

### **Incorrect version or CRC number**

If one or more devices on your Remote Units list does not show the correct version or CRC number, perform a software upgrade for that device. You have three options.

- **Upgrade one unit**  
Use the console's arrow keys to move the cursor to the unit. Press [S3], **Update This Unit**.
- **Upgrade some units**  
Use the console's arrow keys to move the cursor to a unit you want upgraded. Press [S8], **Mark This Unit**, to select that unit. If you want to upgrade others at the same time, repeat this marking procedure for each unit. An M will appear in the lines of marked units. When finished marking, press [S2], **Update Marked**, to upgrade the marked units.
- **Upgrade all units**  
Press [S1], **Update All Units**, to download to all remote units at once.

While code is loading to a remote unit, the percent completion for that unit is shown in the display's Status column. When the word **Pass** appears, the upgrade for that unit is complete.

**NOTE:** *It is normal for software to load faster to an ETCNet2 device than to a Remote Interface Unit or to a Remote Video Interface device.*

### **Finish**

1. Remove the Remote Unit Upgrade disk from the console disk drive.
2. Turn the console off.

# Appendix B

## References

### Remote Interface devices

Until the appearance of ETC's ETCNet2 devices, the only way you could perform remote network operations was with ETC's Remote Interface Unit (RIU) and the Remote Video Interface (RVI). ETC continues to support the RIU and RVI devices but no longer sells them.

This section covers the installation of the RIU and RVI devices with your system. For information about installing ETCNet2 devices, including the ETCNet2 DMX Node and ETCNet2 Video Node, consult the separate Installation Guides for those products.

Install a Remote Interface Unit or Remote Video Interface as follows:

1. Plug the network connector into the appropriate back panel connector. Connections are available for ThinNet or Twisted Pair operation.
2. Plug the power cable into a grounded power outlet.
3. Set DIP switches and/or installing jumpers, as appropriate.
4. Install Remote Unit software (see [Upgrading remote interface devices, page 319](#)) for a discussion and procedure.

### Installing jumpers

A jumper is a small plastic connector used to join a pair of pins sticking out of a printed circuit board. The jumper is installed when it covers both pins. It is not installed when it covers one or none of the pins (see illustration below).

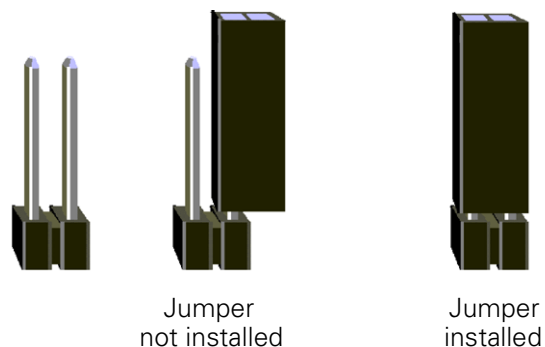

### Remote Interface Unit (RIU)

The illustration below shows the RIU's back panel and indicates the connector used by each accessory. The front panel includes a connector for a digitizer (not used with Express consoles) and an alphanumeric keyboard.

The RIU back panel contains connectors for up to two monitors (only CRT 1 is active), three DMX512 outputs and an RFU.

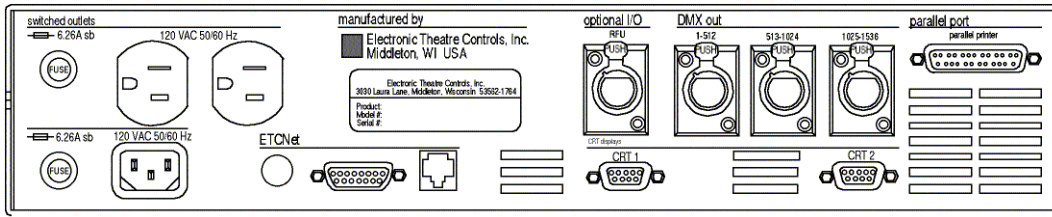

## RIU DIP switch and jumper settings

The RIU's main circuit board contains one 8-switch DIP at location S1 and a set of 14 jumpers at location J22, as shown in the illustration below.

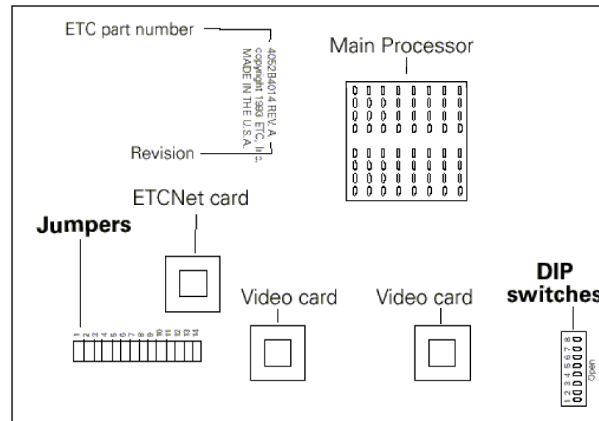

1. Remove the screws that secure the top panel.
2. Raise the top panel to expose the internal circuitry.
3. Locate jumpers 1 through 14. (location **J22**)
4. If your network cable is plugged into the BNC connector (ThinNet), install jumpers 1 through 6. Be certain jumpers 7 through 12 are not installed.
5. If your network cable is plugged into the RJ45 connector (Twisted Pair), install only jumpers 7 through 12. Be certain jumpers 1 through 6 are not installed.
6. Jumper 13 must always be off. Jumper 14 should always be installed.
7. Locate the DIP switches at location **S1** on the corner of the circuit board nearest the power switch. Switches are either **On (Closed)** or **Off (Open)**. **DIP switch 1 must be Off and 2 must be On or the Remote Interface will not start.** Adjust the settings as necessary to match the following table.

<b>DIP Switch</b>	<b>Position</b>	<b>Function</b>
1	Off (Open)	Normal operation, Factory Use Only
2	On (Closed)	Normal operation, Factory Use Only
3	Off (Open)	Normal operation, Factory Use Only
4	Off (Open)	Normal operation, Factory Use Only
5	Off (Open)	Normal operation, Factory Use Only
6	Off (Open)	Normal operation, Factory Use Only
7	Off (Open)	Normal operation, Factory Use Only
8	Off (Open)	Normal operation, Factory Use Only

8. Close the face panel and replace the screws.
9. The Remote Interface checks DIP switch settings when it is turned on. Restart the unit for new DIP switch settings to take effect.

## Replacing RIU fuses

The Remote Interface unit contains two pop-out 6.25 Amp fuses at the left side of the rear panel. Inspect and replace as explained below.

1. Turn off the device.
2. Remove the power cord.
3. Pull the fuse tray out of its holder by placing something sharp behind the tab on the bottom of the cover. The tray remains connected to the tray holder but rotates downward for convenience.

**CAUTION:** Operate the tray carefully to avoid damage.

4. Examine both fuses. Telltale signs of a blown fuse include discoloration or deposits on the glass envelope and/or a visibly broken fuse strip.
5. If you find a blown fuse, replace it with the fuse of the same type and size.
6. With good fuses installed, rotate the tray up and inward until it is again flush with the panel.
7. Replace the power cord and check the console for proper operation. If still having problems, see [Help from ETC Technical Services, page 11](#), to get assistance from ETC.

## Remote Video Interface (RVI)

The Remote Video Interface provides ports for remote accessories. It supports one monitor (the connector labeled **CRT 1** is active), an alphanumeric keyboard and an RFU, and provides a serial port for a digitizer (digitizer not used with Express). The illustrations below show the RVI's front and back panels and indicate the connector used by each accessory.

ETCNet Remote Video Interface back panel

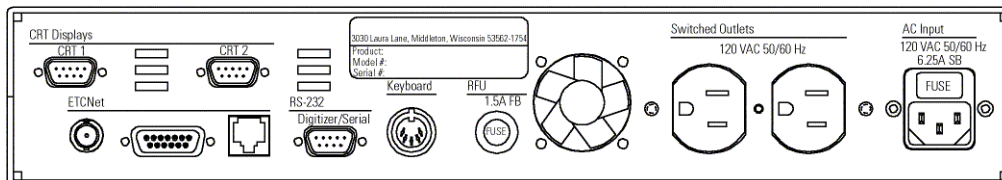

ETCNet Remote Video Interface front panel

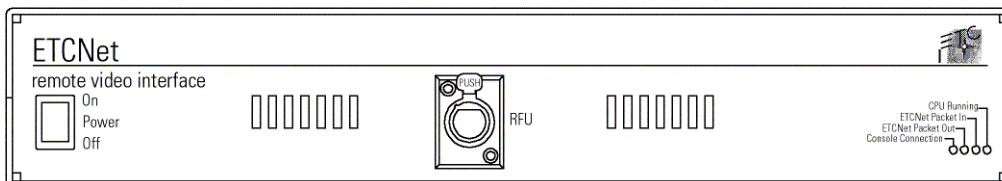

## Fuses

The RVI contains a 6.25 Amp power fuse in a recessed tray at the right side of the rear panel. Inspect and replace this fuse as explained in the section above entitled *Replacing RIU fuses*.

The RVI unit also contains a 1.5 Amp fuse to protect the RFU circuit. This fuse is contained in a pop-out receptacle located near the middle of the rear panel. Inspect and replace this fuse as explained under [External device fuse, page 308](#).

## Remote Video Interface settings

The RVI Processor Board is the lower circuit board in the Remote Video Interface (RVI). It contains one 8-switch DIP. Under normal conditions, these switches will never need to be changed.

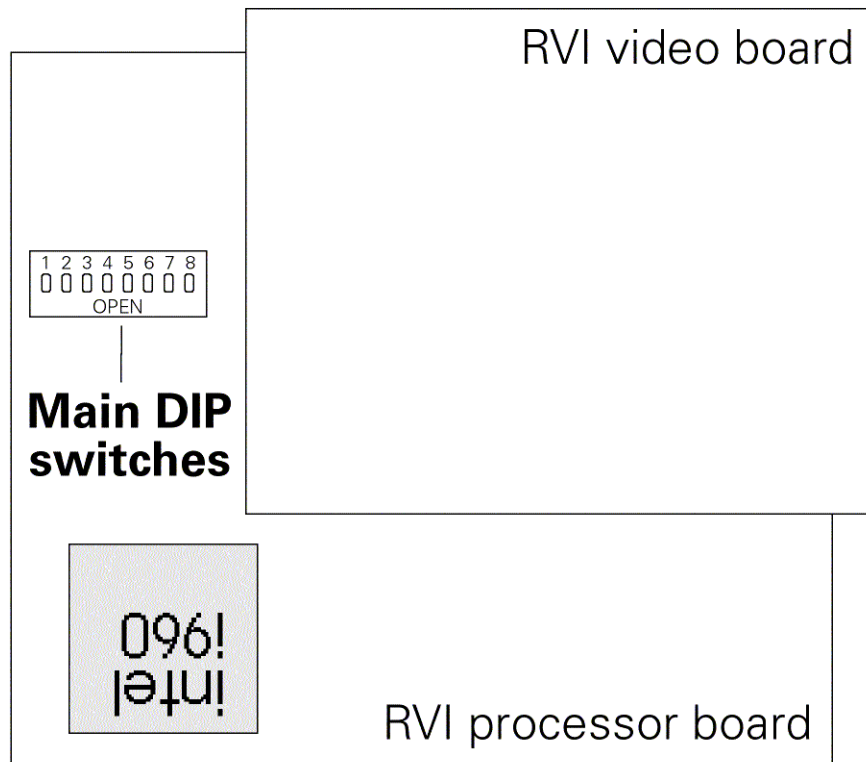

If the settings get changed and you need to restore them, find the switches at location **S4** and adjust the settings as listed below. The RVI checks DIP switch settings when the unit is turned on. You must restart the unit for the new settings to take effect.

<b><u>DIP Switch</u></b>	<b><u>Position</u></b>	<b><u>Function</u></b>
1	On (Closed)	Normal operation, Factory Use Only
2	Off (Open)	Normal operation, Factory Use Only
3	Off (Open)	Normal operation, Factory Use Only
4	Off (Open)	Normal operation, Factory Use Only
5	Off (Open)	Normal operation, Factory Use Only
6	On (Closed)	Normal operation, Factory Use Only
7	On (Closed)	Normal operation, Factory Use Only
8	Off (Open)	Normal operation, Factory Use Only

Switches are either **On (Closed)** or **Off (Open)**.



## ***RVI ETCNet DIP switch settings***

In order to enable the RVI for use on the ETCNet network, you must first adjust the settings of the two sets of ETCNet DIP switches. You will need to use a pin or a similar fine-pointed object to set the switches.

To set the switches, follow these steps.

1. Locate the two sets of DIP switches, visible through the right side panel of the RVI.
2. If the ETCNet cable is plugged into the BNC (ThinNet) connector, set the back six DIP switches to **Off** (up). Set the front six to **On** (down).
3. If the ETCNet cable is plugged into the RJ45 (Twisted Pair) connector or the DB15 (ThickNet) connector, set the front six switches to **Off** (up). Set the back six to **On** (down).

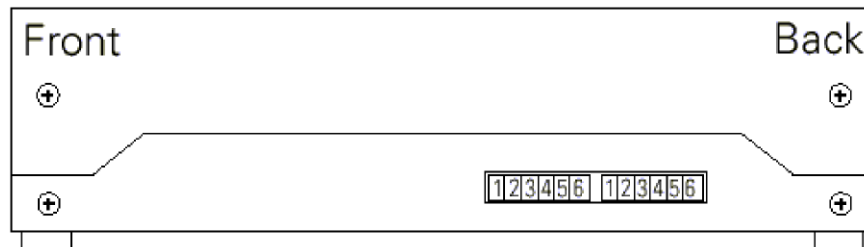

## ***Installing remote video monitors***

You can have additional monitors at remote locations. Connect them to RIUs or RVIs operating on ETCNet. These remote monitors duplicate the console's displays.

Connect monitors to interface devices by following these steps.

1. Insert the female end of the monitor power cord in the monitor connector, and the male end of the monitor power cord in the interface device connector labeled **Switched outlets**.
2. Connect the cable to the connector labeled **CRT 1** on the interface device.
3. Turn monitor power switch to its **On** position.

### ***VGA monitor console connector***

HD-DB15 female

#### ***VGA monitor pinout***

- |    |                       |
|----|-----------------------|
| 1  | Red video             |
| 2  | Green video           |
| 3  | Blue video            |
| 4  | Ground                |
| 5  | Ground                |
| 6  | Red ground            |
| 7  | Green ground          |
| 8  | Blue ground           |
| 9  | not connected         |
| 10 | Ground                |
| 11 | Ground                |
| 12 | not connected         |
| 13 | Horizontal (H/V) sync |
| 14 | Vertical sync         |
| 15 | not connected         |



# *Appendix C*

## *Error messages*

### *Diskette error messages*

***Bad Disk***

Disk is unformatted or defective. Try formatting it. If that doesn't work, try a different disk.

***Corrupted Disk***

This disk is defective. Try formatting it. If that doesn't work, try a different disk.

***Data not recorded on disk***

You cannot read the System Configuration settings from showfiles created with software Version 3.02 or earlier. You must save the show with 3.03 or later software to include System Configuration settings.

***Disk controller failure***

Call ETC Technical Service at 800-775-4382.

***Disk full***

Disk contains other files. Remove enough files to make room for show file.

***File not found***

This disk does not appear to have a show stored on it. Please confirm that you have inserted the correct disk.

***No disk in drive***

Show diskette must be inserted in the diskette drive before you can save or read a show.

***Unknown disk error - try again***

Try the diskette again. If it fails again, call ETC Technical Service at 800/775-4382.

***Write-protected disk***

The write-protect tab on this diskette is open. Close the tab to unprotect the diskette.

### *Other error messages*

***Out of memory***

You have used up all system memory allotted to the function with which you are working. Delete unnecessary parts of the show to free up memory. If this doesn't work, you may want to break the show into two shows, one for each act. This message may also appear if you attempt to run too many effects.

## ***ETCLink errors***

ETCLink is the communications software that serves the Dimmer Monitoring System, explained in [Chapter 23 Dimmer monitoring, page 257](#). ETCLink provides advisory messages for a wide variety of conditions, including information regarding your dimmers, racks, system, data, ports, and loads. These messages fall into two categories, fatal messages and secondary messages.

Fatal messages deal with anything that could potentially terminate or drastically change the look of your show. You may set fatal messages to be displayed even when secondary messages have been disabled.

Secondary messages deal with individual dimmer problems and warnings of potential rack temperature problems. These messages are generally less critical than the fatal messages. If you wish, secondary messages may be disabled without disabling fatal messages. See [Error messages, page 259](#), for more information.

### ***Fatal messages***

**Dimmer # has shut down due to an overtemperature condition. The dimmer will remain shut down until the condition is cleared at the dimmer rack. Use Dimmer Status to determine the rack number for the dimmer.**

**Rack # DMX port A/B failure. Either there is a problem with the DMX cabling/connections between the console and the rack, or the rack has been configured incorrectly.**

**Rack # A/B/C phase input (main) voltage is in error at #V.**

**Rack # input (main) frequency is out of spec at #Hz.**

**Rack # has shut down due to fan failure or other interruption of air flow. Please check the rack, looking for dirty air filters, blocked air passages, or fan failure.**

**ETCLink has failed. Please check cabling and connections. If the problem persists, please call a qualified service technician.**

**Rack # processor error.**

## ***Secondary Messages***

**Dimmer # has a load, but the recorded load is zero. Because the recorded load is zero, the Dimmer Monitoring system is unable to determine whether the dimmer has a load error.**

**The load on dimmer # has changed. Because the dimmer output is not at a high enough level, the Dimmer Monitoring system is unable to determine the size of the load. To correct the problem use [Check Loads] to determine the size of the load change.**

**The load on dimmer # has changed from #W to #W. A decreased load indicates lamp failure. An increased load indicates that a lamp has been added since the last [Record Load]. Correct the problem or, to prevent further error messages, use [Clear Load] or [Record Load].**

**DC output has been detected on dimmer #. If this condition persists, it may harm the connected load. Please check the connected load.**

**An SCR has failed On/Off in dimmer #. The dimmer should be replaced.**

**Dimmer # output has failed on. The dimmer should be replaced.**

**Dimmer # output has failed off. Either the circuit breaker has tripped or the dimmer needs to be replaced.**

**Dimmer #'s load has failed. The most likely cause is a lamp failure. Either replace the lamp or, to prevent further error messages, use [Clear Load] or [Record Load].**

**Data error on Rack # DMX port A/B. Please check DMX cabling and connections between the console and the rack.**

**Rack # ambient temperature is high at # degrees F. The temperature does not yet exceed acceptable operational limits, but the rack should be checked. Please check the cooling/ventilation in the dimmer room.**

**Rack # ambient temperature is low at # degrees F. Please check the heating/ventilation in the dimmer room.**

**Rack # ambient temperature is outside the acceptable operating range at # degrees F. Please check the cooling/ventilation in the dimmer room immediately.**

**A ground fault (GFI/RCD) error has occurred in dimmer #. Use Dimmer status to determine the rack number for the dimmer.**

**The phasing in Rack # is not allowed. The rack has been shut down. Please check the input power service.**



# ***Appendix D***

## ***Showfile***

Each showfile saved with version 3.03 (or later) system software contains recordings or settings in two general programming classifications. Some programming pertains directly to the show, such as recordings of cues, groups and focus points. Other programming pertains to your system configuration, such as clock or MIDI settings that seldom if ever change.

At your option, you can read show and configuration contents separately or at the same time using the console's diskette read operations. If you read show contents only from the diskette, your console's system configuration at that time will not change. Conversely, if you read only the system configuration contents from the diskette, the show information in console memory does not change.

The portion of a showfile that represents show contents is identified below. There are some configuration settings, however, that are also considered part of the show contents. These are identified on the next page. Also identified on the next page is the portion of the showfile that represents configuration contents, and which can be read separately.

### ***Show contents***

- Bump button status
- Channel attribute settings
- Cues and their settings
- Dimmer profile and proportional settings
- Dimmer profile revisions
- Doubled dimmers
- Encoder setup
- Fixture attribute setup
- Focus points
- Groups
- Link lists
- Macros
- Parked channels and dimmers
- Patching for conventional lights
- Patching for ML fixtures
- Show name
- Personalities loaded
- Submasters and their settings
- Time code events

# ***Configuration settings***

## ***Read show results***

Certain configuration information is included with show contents information when you do a *Read Show From Disk* operation. These items are identified below by the display in which each may be edited.

### **Setup display**

Show name

### **System Settings display**

Number of channels

Number of dimmers

Default fade time

Default level

Default fader clear time

Default Sneak Time

### **Output Configuration display**

DMX512 mode

Starting Dimmer

DMX512 speed

### **Options Settings display**

Time code input

Time code frames per second

Display Cue / Time Code list

Powerup macro

### **Time Code Events display**

Clock enable / disable

## ***Read system configuration results***

Certain configuration information is retrieved when you perform a *Read System Configuration From Disk* operation. These configuration items are identified by the display in which each may be edited.

### **System Settings display**

Blackout key

Flexichannel

Master type

Record lockout

Bump keys

### **Options Settings display**

ETC MIDI channel

ETC MIDI show control device IDs

ETCLink (enable)

ETCLink address

Real Time Programs (enable)

External port

Twisted pair polarity

Baud rate

### **ETCLink Functions display**

Display advisories

### **Clock Functions display**

12 / 24 hour clock

Latitude

Longitude

Time zone



# Appendix E

## Softkeys

Stage		
	[Stage]	Stage 2
S1	Sneak	Enable/Disable Quickstep
S2	Update	Sub List
S3	Background Overrides	Solo
S4	Only	Previous Page
S5	Follow	Next Page
S6	Park	Delete
S7	More Softkeys>Stage 2	More Softkeys>Stage 3
S8	Fixture	Flash

Stage		
	Stage 3	[Stage] [Fixture] [Only]
S1	Part	Position
S2	Load Sub	Image
S3		Color
S4	Fader	Beam
S5	Rate	None
S6		Attribute
S7	More Softkeys>Stage	Return
S8	Step	Fixture

Blind/Cue		
	[Blind] [Cue]	Cue 2
S1	Select Cue	Part
S2	Cue List>Cue List	Follow
S3	Spreadsheet>Cue SS	Solo
S4	Only	Previous Page
S5	Rate	Next Page
S6	Delete Cue	
S7	More Softkeys>Cue 2	More Softkeys>Cue
S8	Fixture	

Blind/Cue		
	Cue List	Cue SS
S1	Part	Select Cue
S2	Follow	Create Cue
S3	Rate	Replace Level
S4	Previous Page	Previous Page
S5	Next Page	Next Page
S6	Delete Cue	Delete Cue
S7		Enable/Disable Tracking
S8	Return>Cue	Return>Cue

<b>Blind/Group</b>			
	<b>[Blind] [Group]</b>	<b>Group List</b>	<b>Group SS</b>
<b>1</b>	Select Group		Select Group
<b>2</b>	Group List>Group List		Create Group
<b>3</b>	Spreadsheet>Group SS		Replace Level
<b>4</b>	Previous Page	Previous Page	Previous Page
<b>5</b>	Next Page	Next Page	Next Page
<b>6</b>	Delete Group	Delete Group	Delete Group
<b>7</b>	Only		
<b>8</b>	Fixture	Return>Group	Return>Group

<b>Blind/Focus</b>			
	<b>[Blind] [Focus Point]</b>	<b>Focus List</b>	<b>Focus SS</b>
<b>1</b>	Select Focus		Select Focus
<b>2</b>	Focus List>Focus List		Create Focus
<b>3</b>	Spreadsheet>Focus SS		Replace Level
<b>4</b>	Previous Page	Previous Page	Previous Page
<b>5</b>	Next Page	Next Page	Next Page
<b>6</b>	Delete Focus	Delete Focus	Delete Focus
<b>7</b>	Only		
<b>8</b>	Fixture	Return>Focus	Return>Focus

<b>Blind/Submaster</b>		
	<b>[Blind] [Sub]</b>	<b>Sub 2</b>
<b>1</b>	Select Sub	Bump Status
<b>2</b>	Sub List>Sub List	
<b>3</b>	Spreadsheet>Sub SS	Solo
<b>4</b>	Only	Previous Page
<b>5</b>	Rate	Next Page
<b>6</b>	Delete Sub	
<b>7</b>	More Softkeys>Sub 2	More Softkeys>Sub
<b>8</b>	Fixture	

<b>Blind/Submaster</b>		
	<b>Sub List</b>	<b>Sub SS</b>
<b>1</b>	Bump Status	Select Sub
<b>2</b>	Hold	
<b>3</b>	Rate	Replace Level
<b>4</b>	Previous Page	Previous Page
<b>5</b>	Next Page	Next Page
<b>6</b>	Delete Sub	Delete Sub
<b>7</b>		
<b>8</b>	Return>Sub	Return>Sub

<b>Blind/Cue/Effect</b>			
	<b>[Blind] [Cue /Effect] (CE)</b>	<b>CE 2</b>	<b>CE 3</b>
<b>1</b>	Step	Step	
<b>2</b>	Cue List>Cue List	Step Time	Follow
<b>3</b>	Spread Sheet>Cue SS	In/Dwell/Out	
<b>4</b>	Previous Page	Low/High	
<b>5</b>	Next Page	Insert Step	Rate
<b>6</b>	Delete Cue	Delete Step	
<b>7</b>	More Softkeys>CE 2	More Softkeys>CE 3	More Softkeys>CE
<b>8</b>	Add Channels	Attribute>Attributes	

<b>Blind/(Cue or Sub)/Effect</b>	
	<b>Attributes</b>
<b>1</b>	Positive/Negative
<b>2</b>	Alternate
<b>3</b>	Reverse
<b>4</b>	Bounce
<b>5</b>	Build
<b>6</b>	Random
<b>7</b>	Random Rate
<b>8</b>	Return>CE

<b>Blind/Submaster/Effect</b>			
	<b>[Blind] [Sub/Effect] (SE)</b>	<b>SE 2</b>	<b>SE 3</b>
<b>1</b>	Step	Step	Bump Status
<b>2</b>	Sub List>Sub List	Step Time	
<b>3</b>	Spread Sheet>Sub SS	In/Dwell/Out	
<b>4</b>	Previous Page	Low/High	
<b>5</b>	Next Page	Insert Step	Rate
<b>6</b>	Delete Sub	Delete Step	
<b>7</b>	More Softkeys>SE 2	More Softkeys>SE 3	More Softkeys>SE
<b>8</b>	Add Channels	Attribute>Attributes	

Blind/Subroutine		
	[Blind] [Cue/Subr]	Subr 2
1	Step	Step
2	Cue List>Cue List	Select Cue
3	Spread Sheet>Cue SS	Rate
4	Previous Page	Type/Level
5	Next Page	Insert Step
6	Delete Cue	Delete Step
7	More Softkeys>Subr 2	More Softkeys>Subr
8	Style	Up/Down/Follow

Stage/Fader			
	[Fader]	Fader 2	Fader 3
1	Select Fader	Enable/Disable Quickstep	
2	Update	Load Sub	Part
3	Background Overrides	Solo	
4	Only	Previous Page	
5	Follow	Next Page	Rate
6	Park	Delete	
7	More Softkeys>Fader 2	More Softkeys>Fader 3	More Softkeys>Fader
8	Return	Fixture	Step

Stage/Park	
	[Park]
1	
2	A
3	B
4	Previous Page
5	Next Page
6	
7	
8	Return

Patch		
	[Patch]	Patch 2
1	Dimmer Double	
2	A	
3	B	
4	Previous Page	
5	Next Page	
6	Unpatch	Profile
7	More Softkeys>Patch 2	More Softkeys>Patch
8	Fixture Patch>Fixture Patch	Show/Hide Labels

<b>Setup - System Settings (1), Output Config (2) and Clear (4)</b>			
	<b>System Settings (1)</b>	<b>Output Configuration</b>	<b>Clear Functions</b>
1	Purge Flexi	DMX512 Port	Reset System
2		DMX512 Mode	
3		Starting Dimmer	
4		DMX512 Speed	
5			
6			
7			
8	Return>Setup	Return>Setup	Return>Setup

<b>Setup - Print (5) and Options (6)</b>			
	<b>Print Functions</b>	<b>Options</b>	<b>ESP</b>
1	Stop Printer	Disable MIDI	9,600 Baud
2	Pause Printer	ESP Baud Rate > ESP	14,400 Baud
3			19,200 Baud
4			28,800 Baud
5			38,400 Baud
6			57,600 Baud
7			115,200 Baud
8	Return>Setup	Return>Setup	Return>Options

<b>Setup - Macro Editing (8)</b>		
	<b>Macro Editing</b>	<b>Macro 2</b>
1	Select Macro	On Sub-Bump
2	Insert/Replace	Off Sub-Bump
3	Delete Entry	On Trigger
4		Off Trigger
5		Copy Macro
6	Delete Macro	Macro Enter
7	More Softkeys>Macro 2	More Softkeys>Macro
8	Return>Setup	Macro Wait

<b>Setup - ETC Link Functions (9)</b>			
	<b>ETC Link Functions</b>	<b>System Status (1)</b>	<b>Rack Status (2)</b>
1	Enable/Disable ETCLink	Dimmer Double / Normal Fire Mode	
2	A	Play Backup	
3	B	Record Backup	
4			System Status
5		Dimmer Status	Dimmer Status
6	Unset Dimmer	Rack Status	Select Rack
7	Set Dimmer		
8	Return>Setup	Return>ETC Link	Return>ETC Link

<b>Setup - ETC Link Functions (9)</b>		
	<b>Dimmer Status (3)</b>	<b>Load Management (4)</b>
<b>1</b>		Print Screen
<b>2</b>		
<b>3</b>		
<b>4</b>	System Status	Load Check
<b>5</b>	Select Dimmer	Record Loads
<b>6</b>	Rack Status	Clear Loads
<b>7</b>		Cancel
<b>8</b>	Return>ETC Link	Return>ETC Link

<b>Setup - Profiles (10), Channel Attributes (11)</b>			
	<b>Profiles</b>	<b>Channel Attributes</b>	<b>LL</b>
<b>1</b>	Profile	Independent	Link
<b>2</b>	Percent	Flip	X Channel
<b>3</b>	Clear All	16 Bit	Y Channel
<b>4</b>	Clear to End	Previous Page	Position
<b>5</b>	Fill Between	Next Page	Insert Link
<b>6</b>	Copy to Profile	LTP	Delete Link
<b>7</b>	Reset Profile	Link List>LL	Move Link
<b>8</b>	Return>Setup	Return>Setup	Return>Chan Att

<b>Setup - Real Time Programs (12)</b>		
	<b>Real Time Programs</b>	<b>RTP 2</b>
<b>1</b>	Select Program	Insert Program
<b>2</b>	Time	Copy Program
<b>3</b>	Astro Clock	Move Program
<b>4</b>	Days / Date	Previous Page
<b>5</b>	Macro	Next Page
<b>6</b>		Delete Program
<b>7</b>	More Softkeys>RTP 2	More Softkeys>RTP
<b>8</b>	Return>Setup	Sort

<b>Setup - Time Code (13)</b>			
	<b>Time Code (TC)</b>	<b>TC 2</b>	<b>TC 3</b>
<b>1</b>	Internal Clock	Select Event	Insert Event
<b>2</b>	Clock Enable/Disable	Code Time	Copy Event
<b>3</b>	Manual Mode	Cue	Move Event
<b>4</b>	Pause Mode	Rate	Previous Page
<b>5</b>	Step	Bump	Next Page
<b>6</b>	Learn Mode	Macro	Delete Event
<b>7</b>	More Softkeys>TC 2	More Softkeys>TC 3	More Softkeys>TC
<b>8</b>	Return>Setup	Reset Loop	Sort

<b>Setup - Moving Light Functions (15)</b>			
	<b>Personality Setup</b>	<b>Fixture Patch</b>	<b>FP 2</b>
<b>1</b>	From Disk	Select Fixture	Select Fixture
<b>2</b>			Start Channel
<b>3</b>	View Personality	Personality	DMX512 Port/Start
<b>4</b>		Previous Page	Remote Dimmer
<b>5</b>		Next Page	Swap Focus
<b>6</b>	Delete Personality	Delete Fixture	Flip
<b>7</b>	Reset Defaults	More Softkeys>FP2	More Softkeys >FP
<b>8</b>	Return>Moving Light Ftns	Return>Moving Light Ftns	Autoload Encoders

<b>Setup - Moving Light Functions (15)</b>		
	<b>Attribute Setup</b>	<b>Encoder Setup</b>
<b>1</b>	Select Attribute	Select Encoder
<b>2</b>	Category	Page
<b>3</b>		Attribute
<b>4</b>	Previous Page	
<b>5</b>	Next Page	
<b>6</b>		Autoload Encoders
<b>7</b>	Reset Defaults	Reset Defaults
<b>8</b>	Return>Moving Light Ftns	Return>Moving Light Ftns





# Appendix F

## Time and location

### United States cities

<b>City, State</b>	<b>Time Zone (Standard)</b>	<b>Latitude</b>	<b>Longitude</b>
Albuquerque, NM	+ 7 West	35° 03' N	106° 37' W
Anchorage, AK	+ 10 West	61° 10' N	149° 11' W
Atlanta, GA	+ 5 West	33° 39' N	84° 26' W
Baltimore, MD	+ 5 West	39° 11' N	76° 40' W
Augusta, ME	+ 5 West	44° 19' N	69° 48' W
Billings, MT	+ 7 West	45° 47' N	108° 32' W
Boise, ID	+ 7 West	43° 36' N	116° 13' W
Boston, MA	+ 5 West	42° 20' N	71° 01' W
Buffalo, NY	+ 5 West	42° 53' N	78° 51' W
Burlington, VT	+ 5 West	44° 29' N	73° 13' W
Charleston, SC	+ 5 West	32° 47' N	79° 59' W
Cheyenne WY	+ 6 West	41° 08' N	104° 47' W
Chicago, IL	+ 6 West	41° 50' N	87° 41' W
Columbus, OH	+ 5 West	40° 00' N	82° 53' W
Dallas, TX	+ 6 West	32° 47' N	96° 45' W
Denver, CO	+ 7 West	39° 46' N	104° 52' W
Des Moines, IA	+ 6 West	41° 34' N	93° 37' W
Detroit, MI	+ 5 West	42° 22' N	83° 06' W
Fargo, ND	+ 6 West	46° 52' N	96° 49' W
Hartford, CT	+ 5 West	41° 45' N	72° 41' W
Honolulu, HI	+ 10 West	21° 79' N	157° 48' W
Kansas City, MO	+ 6 West	39° 07' N	94° 33' W
Las Vegas, NV	+ 7 West	36° 12' N	115° 13' W
Lincoln, NE	+ 6 West	40° 48' N	96° 41' W
Little Rock, AR	+ 6 West	34° 43' N	92° 21' W
Los Angeles, CA	+ 8 West	34° 05' N	118° 24' W
Indianapolis, IN	+ 5 West	39° 44' N	86° 17' W
Madison, WI	+ 6 West	43° 04' N	89° 23' W
Nashville, TN	+ 6 West	36° 07' N	86° 41' W
Miami, FL	+ 5 West	25° 49' N	80° 13' W
Minneapolis, MN	+ 6 West	44° 57' N	93° 16' W
Montgomery, AL	+ 6 West	32° 21' N	86° 17' W
New Orleans, LA	+ 6 West	30° 03' N	89° 55' W
New York, NY	+ 5 West	40° 46' N	73° 58' W
Oklahoma City, OK	+ 6 West	35° 28' N	97° 30' W
Philadelphia, PA	+ 5 West	40° 00' N	75° 08' W
Phoenix, AZ	+ 7 West	33° 32' N	112° 04' W
Portland, OR	+ 8 West	45° 32' N	122° 39' W
Raleigh, NC	+ 5 West	35° 52' N	78° 47' W
Salt Lake City, UT	+ 7 West	40° 46' N	111° 55' W
San Francisco, CA	+ 8 West	37° 47' N	122° 33' W
Seattle, WA	+ 8 West	47° 37' N	122° 21' W
Sioux Falls, SD	+ 6 West	43° 32' N	96° 43' W
Washington D.C.	+ 5 West	38° 54' N	77° 00' W

## ***Cities outside the United States***

<b>City, State</b>	<b>Time Zone (Standard)</b>	<b>Latitude</b>	<b>Longitude</b>
Abuja, Nigeria.....	- 1 East	9° 12' N	7° 11' E
Algiers, Algeria.....	- 1 East	36° 47' N	3° 3' E
Amsterdam, Netherlands.....	- 1 East	52° 17' N	4° 57' E
Ankara, Turkey.....	- 2 East	39° 56' N	32° 52' E
Athens, Greece.....	- 2 East	37° 58' N	23° 43' E
Bangkok, Thailand.....	- 7 East	13° 44' N	100° 31' E
Berlin, Germany.....	- 1 East	52° 27' N	13° 22' E
Berna, Switzerland.....	- 1 East	46° 57' N	7° 26' E
Bombay, India.....	- 6 East	18° 54' N	72° 49' E
Brussels, Belgium.....	- 1 East	50° 50' N	4° 20' E
Buenos Aires, Argentina.....	+ 3 West	34° 36' S	58° 27' W
Cairo, Egypt.....	- 2 East	30° 03' N	31° 15' E
Cape Town, South Africa.....	- 2 East	33° 55' S	18° 22' E
Casablanca, Morocco.....	0	33° 39' N	7° 35' W
Copenhagen, Denmark.....	- 1 East	55° 40' N	12° 35' E
Dublin, Ireland.....	0	53° 20' N	6° 15' W
Edinburgh, Scotland.....	0	55° 57' N	3° 13' W
Edmonton, Alberta, Canada.....	- 7 West	53° 33' N	113° 28' W
Fukuoka, Japan.....	- 9 East	33° 35' N	130° 24' E
Helsinki, Finland.....	- 2 East	60° 10' N	24° 58' E
Hong Kong.....	- 8 East	22° 18' N	114° 09' E
Jakarta, Indonesia.....	- 7 East	6° 10' S	106° 48' E
Lima, Peru.....	+ 5 West	12° 03' S	77° 03' W
Lisbon, Portugal.....	0	38° 43' N	9° 8' W
London, England.....	0	51° 30' N	0° 0' W
Madrid, Spain.....	- 1 East	40° 24' N	3° 41' W
Marseilles, France.....	- 1 East	43° 18' N	5° 23' E
Mexico City, Mexico.....	+ 6 West	19° 24' N	99° 09' W
Montreal, Quebec, Canada.....	+ 5 West	45° 30' N	73° 36' W
Moscow, Russia.....	- 3 East	55° 46' N	37° 20' E
Munich, Germany.....	- 1 East	48° 09' N	11° 34' E
Oslo, Norway.....	- 1 East	59° 56' N	10° 44' E
Paris, France.....	- 1 East	48° 49' N	2° 29' E
Prague, Czechoslovakia.....	- 1 East	50° 05' N	14° 25' E
Reykjavik, Iceland.....	0	64° 08' N	21° 56' E
Riga, Latvia.....	- 3 East	56° 40' N	106° 10' E
Rio De Janeiro, Brazil.....	+ 3 West	22° 55' S	43° 12' W
Rome, Italy.....	- 1 East	41° 48' N	12° 36' E
San Juan, Puerto Rico.....	+ 4 West	18° 29' N	66° 07' W
Santiago, Chile.....	+ 4 West	33° 27' S	70° 42' W
Sapporo, Japan.....	- 9 East	43° 04' N	141° 21' E
Seoul, Korea.....	- 9 East	37° 34' N	126° 58' E
Singapore, Malaysia.....	- 8 East	1° 14' N	103° 55' E
Stockholm, Sweden.....	- 1 East	59° 21' N	18° 04' E
Sydney, Australia.....	- 10 East	33° 52' S	151° 12' E
Taipei, Taiwan.....	- 8 East	25° 02' N	121° 31' E
Tokyo, Japan.....	- 9 East	35° 41' N	139° 46' E
Toronto, Ontario, Canada.....	+ 5 West	43° 39' N	79° 23' W
Vancouver, B.C., Canada.....	+ 8 West	49° 15' N	123° 07' W
Vienna, Austria.....	- 1 East	48° 15' N	16° 22' E
Warsaw, Poland.....	- 1 East	52° 13' N	21° 02' E
Wellington, New Zealand.....	- 12 East	41° 71' S	174° 46' E

# ***Appendix G***

## ***Specifications***

### ***Electrical***

- Voltage input 100-240 VAC, 50-60 Hz
- Maximum current 0.8 amps

### ***Built-in interfaces***

- 1,024 DMX512 outputs
- Parallel printer
- Remote Focus Unit
- Remote Macro control
- Remote Trigger option
- MIDI Time code control
- ETCLink
- Console lights

### ***System capacity***

- 600 cues per show
- 125 or 250 control channels
- Proportional patching of up to 1,024 DMX512 dimmers
- Eight-part multipart cues
- Thirty-three dimmer profiles, all but one of which are editable
- 500 groups
- 99 focus points
- 2,000 macros
- 24 overlapping submasters
- Ten pages of submaster memory
- Two timed/manual fader pairs

### ***Fader functions***

- Fade times programmable from 0.1 seconds to 99:59 minutes
- Manual override of upfade and/or downfade
- Rate override
- Split time fades
- Manual fades
- Background fades with LTP channels
- User selectable default fade times
- Hold/Back functions

### ***Playback controls***

- Two timed/manual fader pairs
- Two [Go] buttons
- Two [Hold] buttons
- Two [Back] buttons
- Two [Rate] buttons

- Two [Clear] buttons
- 24 submasters
- Programmable Master on 100mm potentiometer
- Blackout function
- Trackpad
- Eight softkeys to streamline operations

### ***Timed control***

- Internal or external clock
- 12-hour or 24-hour timing
- References sunrise and sunset with astronomical clock
- Up to 500 user-created, Real Time Programs

### ***Display functions***

- VGA video output
- Extensive online Help displays available for all functions
- Stage
- Blind
- Fader
- Effects
- Spreadsheets: Cues, Submasters, Groups and Focus Points
- Patch
- Park
- Setup
- Flexichannel (displays only recorded channels)
- Channel attributes

### ***Submaster functions***

- Ten pages of recorded submasters each
- Fully overlapping channel assignments
- Proportional channel levels
- The bump buttons for all submasters may be enabled, disabled or placed in solo mode as a group or individually
- Integral LEDs on all submasters
- Programmable fade and wait times
- Live and programmed rate control
- Submasters either overlapping pile-on or inhibitive
- All submasters programmable with effects
- Update function
- Control keypad features
- Spreadsheet editing
- Submaster list

## ***Channel functions***

- 8-bit and 16-bit data types
- Both highest level (Highest Takes Precedence) and last action (Latest Takes Precedence) channel types
- Group function to proportionally manipulate channels
- [And], [Except], [Only], and [Thru] functions for selection of control lists
- [Full] function
- [Level] sets a channel to an editable default value
- Independent channels
- Flip channel
- Link List allows channels to be linked together for control by the trackpad

## ***Moving light functions***

- Fixture personalities may be loaded from diskette
- Patch fixtures by assigning personalities, starting channels, starting DMX512 address, remote dimmer, swap focus, pan or tilt flip
- Five attribute categories
- Fixture box level adjustment
- Fixture focus with Solo

## ***Cue functions***

- Up to 600 cues in the range 0.1 to 999.9
- Discrete upfade and downfade times (00:00-99:59) for each cue
- Linked cue sequences
- Effect cues
- Split wait times
- Follow time
- Link to cue or macro
- Eight-part multipart cues
- Selective cue recording
- Update cue command
- Attribute range editing
- Subroutines, with cue or style steps
- Spreadsheet editing
- Cue list

### ***Group functions***

- Up to 500 groups
- Any cue or submaster may be accessed as a group
- Spreadsheet editing
- Group list

### ***Focus point functions***

- up to 99 preset focus points
- Hard key for quick access
- Update cues and submasters when focus point changes
- Record level of focus point without link
- Available in effects
- Printout available
- Spreadsheet editing
- Focus point list

### ***Diskette functions***

- 3.5-inch high-density diskette drive for show storage
- One show per disk
- Software updates installed through diskette drive
- Retrieve show and configuration contents separately or together

### ***Macro functions***

- Up to 2,000 macro selections for programming
- Macros may activate any key except [Enter Macro]
- Live Learn mode
- Macro editing
- Macros programmable for **Macro wait**
- Can include in real time programs
- Can include in time code events
- Four macros operated by remote switches
- Powerup macro
- Remote Trigger function

### ***Effects functions***

- Effects may be recorded as cues or submasters
- Up to 100 steps each
- Live effects recording
- Spreadsheet editing
- 8-bit and 16-bit data types
- Variability of rate during playback
- Step times
- In/Dwell/Out Step fade times
- High/Low Levels
- In/Dwell/Out Effect fade times
- Range editing of effect attributes and step values

### ***Profile functions***

- Profiles may be assigned to dimmers
- Ten preset profiles, nine of which are editable
- Twenty-three additional profiles that may be programmed

### ***Options***

- Parallel printer
- Remote Focus Unit
- Lighting Playback Controller
- Remote Interface Unit
- Remote Video Interface
- Remote Macro controls
- Console lights

### ***Size and weight***

- 35 x 15 x 6 inches
- 21 pounds





# Appendix H

## Declaration of Conformity



### DECLARATION OF CONFORMITY

We, Electronic Theatre Controls, Europe Limited  
Unit 5, Victoria Industrial Estate, London W3 6UU United Kingdom  
declare under sole responsibility that the product

Product name: Express Lighting Control Console  
Product type/model: Express 24/48, Express 48/96, Express 72/144,  
Express 125 and Express 250  
Lot: n/a  
Batch / Serial number: n/a  
Item numbers: one of each model

to which this declaration relates is in conformity with the following standards:

EN60950 Safety of Information Technology Equipment  
following the provisions of EU LV Directive(s) 73/23/EEC  
EN55022 Emissions standard for IT equipment (class B environment)  
EN50081-1 Generic emissions standard for residential, commercial and  
light industrial applications  
EN50082-2 Generic immunity standard for industrial applications  
following the provisions of EU EMC Directive(s) 89/336/EEC and 92/31/EEC

London, United Kingdom  
(Place of issue)

3<sup>rd</sup> Oct 1997  
(Date of Issue)

Mr Adam Bennette  
(Name of authorised person)

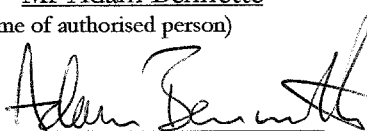
  
(signature of authorised person)



# *Appendix I*

## *Limited Warranty*

Electronic Theatre Controls, Inc. (ETC™) warrants to the original owner or retail customer (Customer) that during the warranty period ETC will repair or replace its products that are defective in materials or workmanship under normal use and service, subject to the terms of this limited warranty. The warranty period shall begin on the date of delivery of a portable system or on the date of energization of a permanently installed system, and shall continue for the following periods: (a) one year, for all Irideon products, and (b) two years, for all other ETC products. Warranty is limited to (60) days from shipment for purchase of demo or loaner products.

Warranty does not cover any product or part of a product subject to accident, negligence, alteration, abuse or misuse, or any accessories or parts not supplied by ETC. Warranty does not cover "consumable" parts such as fuses, lamps, color media or components warranted directly to the owner by the original manufacturer. ETC's warranty does not extend to items not manufactured by us. Freight terms on warranty repairs are FOB ETC factory or designated repair facility. Collect shipments or freight allowances will not be accepted.

ETC's sole responsibility under this warranty shall be to repair or replace at ETC's option such parts as shall be determined to be defective on ETC's inspection. ETC will not assume any responsibility for any labor expended or materials used to repair any equipment without ETC's prior written authorization. ETC SHALL NOT BE RESPONSIBLE FOR ANY INCIDENTAL, GENERAL OR CONSEQUENTIAL DAMAGES, DAMAGES TO PROPERTY, DAMAGES FOR LOSS OF USE, TIME, PROFITS OR INCOME, OR ANY OTHER DAMAGES.

The customer's obligations during the warranty period under this warranty are to notify ETC at ETC's address within one week of any suspected defect, and to return the goods prepaid to ETC at their factory or authorized service center.

THIS WARRANTY IS CONTINGENT ON THE CUSTOMER'S FULL AND TIMELY COMPLIANCE WITH THE TERMS OF PAYMENT SET FORTH IN THE "TERMS AND CONDITIONS." THIS WARRANTY IS EXPRESSLY IN LIEU OF ANY AND ALL OTHER WARRANTIES EXPRESSED OR IMPLIED, INCLUDING THE WARRANTIES OF MERCHANTABILITY AND FITNESS FOR A PARTICULAR PURPOSE AND OF OTHER OBLIGATIONS AND LIABILITIES ON OUR PART. THE CUSTOMER ACKNOWLEDGES THAT NO OTHER REPRESENTATIONS WERE MADE TO HIM OR RELIED UPON BY HIM WITH RESPECT TO THE QUALITY AND FUNCTION OF THE GOODS SOLD.

This written warranty is intended as a complete and exclusive statement of the terms thereof. Prior dealings or trade usage shall not be relevant to modify, explain or vary this warranty. Acceptance of, or acquiescing in, a course of performance under this warranty shall not modify the meaning of this agreement even though either party has knowledge of the performance and a chance to object.

### **Terms and Conditions**

The following terms and conditions, and those on the face hereof, shall control as to any order accepted by Electronic Theatre Controls, Inc. (ETC), notwithstanding any terms and conditions that may be contained in any purchase order or other document of Customer, and ETC's acceptance of any order is expressly made conditional on Customer's assent to such terms and conditions. Such terms and conditions will constitute the entire agreement between the parties as to any order and will supersede any prior understandings, agreements, representations, or warranties. Such terms and conditions will not be modified, added to, superseded or otherwise altered except by written document signed by an authorized representative of ETC, notwithstanding any terms and conditions contained in the purchase order or other document of Customer. ETC's

commencement of performance and/or delivery shall not constitute a waiver of these terms and conditions or any acceptance of any terms and conditions contained in the Customer's order or other documents. Acceptance of any product or service by the Customer will be construed as acceptance of ETC's terms and conditions. Any dispute or questions of construction with respect to any order placed with ETC shall be governed by the laws of the State of Wisconsin.

All prices are in US Dollars, FOB ETC's factory or warehouse. Prices, models and specifications are subject to change without notice. Orders must be in writing. Phone orders will be accepted from established accounts when followed by written confirmation. The acceptance of any order does not imply conformance with plans and specifications unless the plans and specifications accompany the order and are accepted as binding by ETC. Equipment ordered which differs in any way from our standard catalog items will require drawings approved in writing by the Customer. When drawings are approved, they shall take precedence over all other written or verbal instructions. Orders are effective only when accepted and acknowledged by the factory. Minimum order is \$25.00 net, exclusive of freight.

Price protection will be given on orders entered for immediate shipment and for project orders entered before the effective date of a price increase. All other orders will be billed at the current price at time of shipment. Quotations for custom products are valid for thirty (30) days.

ETC will attempt to ship goods for delivery on or about the times stated on the reverse side hereof, although time shall not be the essence in this contract. ETC will attempt to follow customer's written instructions as to mode and routing of shipments. In absence of such instructions, ETC shall have absolute discretion as to mode and routing of shipments, including express or parcel post for small shipments. Where the customer has requested expedited freight, the customer will be responsible for the incurred additional charges.

ETC shall not be liable for late delivery and/or inability to perform due to unforeseen circumstances or conditions, including our

ability to obtain supplies and raw materials, government regulations, labor stoppages, casualties, fire, and other causes beyond our control. When such circumstances or conditions have been remedied, ETC will make and Customer will accept delivery/performance. Equipment is shipped at the Customer's risk and our obligation to deliver equipment is discharged upon their delivery in good condition to the carrier. Shipments are FOB ETC factory or warehouse. ETC will prepay and bill freight on UPS shipments. Freight and air are sent collect unless specifically quoted otherwise. Unless specifically prohibited, partial shipments will be made. Federal, state and/or local taxes, duties and other charges are the responsibility of the purchaser.

Any changes in engineering drawings, specifications, or in other terms of manufacture, assembly or shipment, requested by customer, must be in writing and approved by ETC. If any such change by Customer causes an increase in the cost of, or in the time required for performance of, any part of the contract, then ETC shall make a reasonable adjustment to the price of the goods.

If purchaser cancels any portion of a Purchase Order prior to shipment, Purchaser shall be liable to ETC for a cancellation charge equal to ETC's actual costs incurred in connection with that portion of the Purchase Order that is cancelled, including, without limitation, labor and materials. Customer represents that it is solvent. ETC retains a security interest in the goods to secure payment of the purchase price and all other indebtedness now or hereafter owed by the customer to ETC. At ETC's request, customer will execute a financing statement or statements evidencing such security interest and will take any other action necessary to perfect the same.

Payment terms are net 30 days after date of invoice. If ETC in good faith doubts customer's ability or willingness to pay, ETC may in its discretion complete its performance of this contract upon a cash in advance basis or make deliveries only upon a C.O.D. basis or file a UCC filing or suspend all or part of its performance hereunder. All payments are applied to the oldest outstanding invoice. Accounts over thirty (30) days are subject to a 1 1/2% (one

and one-half percent) per month late payment penalty. ETC will have the option of withholding performance under any and all orders from the Customer if an invoice remains unpaid after 30 days. All disputes otherwise unresolved between ETC and Customer shall be resolved in a court of competent jurisdiction in the location of ETC's offices, Dane County, Wisconsin. If suit or action is instituted by ETC to enforce payment or performance by the Customer, the Customer agrees to pay all costs and attorney's fees incurred.

Claims for shortage or damaged goods must be made within ten (10) days. Equipment is carefully packed and delivered in good condition to the carrier. All claims for loss or damage in transit must be made by the consignee directly to the carrier. ETC will render every aid and assistance in the presentation and enforcement of such claims without waiver of our rights to have compliance with the terms of payment of our invoices.

Equipment returned without ETC's written permission will not be accepted. Equipment returned for credit must be in accordance with established RMA procedures. Equipment must be unused, in original cartons and in saleable condition, subject to ETC's quality control and test inspection. Restocking charges of \$25.00 or 25% of invoice (whichever is greater) plus any repacking or reconditioning costs will be deducted from the credit. Returns for warranty work will be via warranty procedures. In no case will permission be granted to return specially-modified or custom equipment, or merchandise invoiced more than six (6) months prior to date of Customer's return request.

No failure of ETC to insist upon or compel compliance by the customer with any of these terms and conditions shall be construed as a waiver by ETC of its right to insist upon compliance. No waiver by ETC of any breach by customer shall be effective unless in writing signed by ETC, and no waiver by ETC of any breach by customer shall be deemed a waiver of any other breach.

If ETC shall fail to repair or replace defective goods within a reasonable time after they are returned to ETC, or if ETC shall wrongfully fail to make delivery or shall wrongfully repudiate this contract, then customer shall be entitled to recover from ETC such part of the purchase price as has been paid by customer to ETC. The remedy stated in the preceding sentence shall be customer's exclusive remedy for any breach, non delivery, or repudiation by ETC or for any other liability of ETC to customer. This exclusive remedy shall not be deemed to have failed its essential purpose so long as ETC is willing and able to repair or replace defective parts in the prescribed manner.



# Index

## Numerics

- 16-bit
  - About Channel . . . . . 60
  - Enable . . . . . 53
- 1-to-1 Patch . . . . . 36

## A

- A/B display
  - Status . . . . . 16
- About Channel
  - Background overrides . . . . . 5
  - Explained . . . . . 60
- About Dimmer
  - Error reporting . . . . . 259
  - Explained . . . . . 46–47
- About Show . . . . . 33
- Accessories
  - Remote Focus Unit . . . . . 304
- Allfade cue
  - Blackout cue . . . . . 108
  - Cue type . . . . . 80
  - Subroutine step . . . . . 220
- Alphanumeric keyboard
  - Function
  - Installation . . . . . 314
- Astronomical Clock . . . . . 32

## B

- Back key . . . . . 121
- Back panel diagram . . . . . 308
- Background
  - Channel . . . . . 17
  - Fader . . . . . 4
  - Override . . . . . 5
- Backup looks
  - Playing . . . . . 270
  - Recording . . . . . 269
  - System Status display . . . . . 261
- Backup, power fail . . . . . 10
- Baud Rate . . . . . 300
- Blackout cue . . . . . 108
- Blackout key
  - Enable/Disable . . . . . 27
  - With Park . . . . . 189
- Blind
  - Cue List . . . . . 172
  - Display . . . . . 16
  - Multipart cues . . . . . 115
- Blocking cue
  - Cue type . . . . . 80
  - Explained . . . . . 6

- Bump buttons
  - Enable/Disable . . . . . 29
  - Status . . . . . 155

## C

- C/D display
  - Status . . . . . 16
- Captured channels
  - Defined . . . . . 52
  - In Patch . . . . . 44
- Category
  - Default assignments . . . . . 71
  - Definition . . . . . 7
  - Reset defaults . . . . . 72
- CD80 . . . . . 49
- Channel
  - About . . . . . 60
  - Captured . . . . . 52
  - Captured in Patch . . . . . 44
  - Channel check . . . . . 59
  - Channel levels . . . . . 51
  - Color . . . . . 14
  - Flash . . . . . 57
  - Full . . . . . 57
  - Match to submasters . . . . . 28
  - Modes . . . . . 52
  - Moving . . . . . 52
  - Park . . . . . 192
  - Recorded . . . . . 52
  - Release captured . . . . . 52
  - Selected . . . . . 52
  - Selecting channels . . . . . 56
  - Set number . . . . . 23
  - Sneak . . . . . 58
  - Specifications . . . . . 345
  - System settings . . . . . 23
  - Tracked . . . . . 52
- Channel Attributes
  - Clear . . . . . 255
  - Print . . . . . 251
  - Settings . . . . . 53–55
- Channel zero
  - Setting dimmer count . . . . . 22
  - Unpatching dimmers . . . . . 39
- Check
  - Channel . . . . . 59
  - Cue . . . . . 127
  - Dimmer . . . . . 45
  - Dimmer loads . . . . . 266
- Clear
  - Channel attributes . . . . . 255
  - Clear Functions menu . . . . . 254

Fader	121	Cue check	127
Functions	254	Cue/Command	172
Groups	137, 149	Default Fade Time	24
Loads	267	Delete	98
Macros	233	Follow	89
Moving lights	255	Go	121
Patch	255	Go to	124
Real time programs	255	Hold	121
Reset system	254	Insert	100
Show	255	Label	305
SMPTE events	292	Link cues	88
Submasters	170	Link to macro	91
Time code events	255	Load to sub	169
Clock		Maximum number	79
Real time	30–32	Modify	103
Time code, external	298	Modify attributes	95
Time code, internal	297	Multipart, defined	111
Color		Parked cue	194
Channel/Fixture	14	Play cue	124
LEDs	156	Print	251
Submasters	172	Quickstep	127
Tracked channels defined	52	Record	87
Color scrollers	239	Record from stage	83
Configuration		Record in Blind	84
Read from disk	247	Record with fade time	85
Saved to showfile	331	Record with split fades	86
Write to diskette	245	Recording with solo	92, 131
Connectors		Select cue	124
Alphanumeric keyboard	314	Specifications	345
Dimmer	311	Spreadsheet	179
Monitor	325	Stage	83
Printer	315	Subroutine	80
RFU	315	Subroutine steps	220
Copy		Type	80
Cue or group to sub	170	Update	96–97
Cues	99	View	81
Macro	234	Custom patch	37
SMPTE events	293	<b>D</b>	
Submasters	169, 170	Data Type	55
Crossfade cue		Date, set clock	30
Cue type	80	Default	
Subroutine step	220	Channel/Submaster link	28
Cue	79	Dimmer profiles	43
Allfade	80	Encoder	74
Back key	121	Fade Time	24
Blackout	108	Fader Clear Time	25
Blackout cue	108	Level	25
Blind	84	Submaster times	157
Blocking	6	Delete	
Clear	255	Cues	98
Command display list	172	Fixture	70
Convert to multipart	113	Focus point	149
Copy	99	Group	137
Copy to sub	170	Link	242
Crossfade	80	Macro	233



Part of multipart cue . . . . .	115	Write showfile . . . . .	245
SMPTE events . . . . .	292	Display	
Submaster . . . . .	170	Blind . . . . .	16, 84
Dimmer		Channel Attributes . . . . .	53
About Dimmer . . . . .	46	Clear Functions . . . . .	254
About with ETCLink . . . . .	47	Cue List . . . . .	172
Check . . . . .	45	Dimmer System Status . . . . .	261
Clear loads . . . . .	267	Diskette Functions . . . . .	243
Dimmer check . . . . .	45	ETCLink Functions . . . . .	257
Dimmer Status display . . . . .	263	Fixture patch . . . . .	68
DMX512 port start . . . . .	312	Flexichannel . . . . .	18
DMX512 speed . . . . .	313	General features . . . . .	15
Error messages . . . . .	259	Macro . . . . .	228
Installation . . . . .	311	Output Configuration . . . . .	312
Load check . . . . .	266	Patch . . . . .	19
Park dimmer . . . . .	190	Print Functions . . . . .	250
Patch . . . . .	35, 37	Rack status . . . . .	262
Pinout . . . . .	311	SMPTE Edit . . . . .	288
Port setup . . . . .	312	Specifications . . . . .	344
Rack status . . . . .	262	Stage . . . . .	16
Record loads . . . . .	265	Time Code Events . . . . .	287
Sensor . . . . .	257	DMX512	
Set . . . . .	268	About Dimmer . . . . .	46, 47
Strand CD80 rack . . . . .	49	Connecting . . . . .	311
Unpatch . . . . .	39	Set port start . . . . .	312
Unset . . . . .	268	Set signal speed . . . . .	313
Dimmer Double		Double mode . . . . .	9
Set dimmers . . . . .	48	Dwell time	
Set DMX512 port . . . . .	312	Changing for submaster . . . . .	158
System Status display . . . . .	261	Effects . . . . .	216
Dimmer profiles		Submaster Hold/Manual . . . . .	159
Assign to dimmer . . . . .	41	<b>E</b>	
Programming . . . . .	42–43	Edit	
Reset defaults . . . . .	43	Clear submasters . . . . .	170
DIP switch		Copy cues . . . . .	99
ETCNet . . . . .	325	Copy submaster . . . . .	169, 170
Remote Interface . . . . .	322	Cue List . . . . .	172
Remote Video Interface . . . . .	324–325	Delete cue . . . . .	98
Disable		Delete part from multipart . . . . .	115
Blackout key . . . . .	27	Events . . . . .	288
Bump buttons . . . . .	29	Load submaster . . . . .	169
Flexichannel . . . . .	27	Macro . . . . .	233
MIDI Show Control . . . . .	275	Range of submasters . . . . .	174
Record Lockout . . . . .	29	Effect	
Discover nodes . . . . .	320	Create in Blind . . . . .	200
Diskette		Create in Stage . . . . .	204
Drive specifications . . . . .	346	Cue type . . . . .	80
Erase diskette . . . . .	244	Fade times . . . . .	214
Error messages . . . . .	327	Insert steps . . . . .	210
Format . . . . .	244	LTP channels in . . . . .	6
Management . . . . .	244	Specifications . . . . .	346
Read all . . . . .	246	Submaster . . . . .	217
Read configuration only . . . . .	247	Submaster type . . . . .	152
Read show only . . . . .	247	Update . . . . .	207
Write configuration . . . . .	245	Effect submaster defined . . . . .	152

Enable	
Blackout key . . . . .	27
Bump buttons . . . . .	29
ETCLink . . . . .	258
Flexichannel . . . . .	27
Record Lockout . . . . .	29
Encoder	
Autoload . . . . .	74
Print setup . . . . .	251
Reset defaults . . . . .	74
Setup . . . . .	73–74
Error messages	
About Dimmer . . . . .	47
Diskette . . . . .	327
Other . . . . .	327
ETC locations . . . . .	11
ETC MIDI	
<i>(See, also, MIDI Show Control)</i>	
Message format . . . . .	273
ETCLink	
About Dimmer . . . . .	47
Backup looks . . . . .	269
Clear Loads . . . . .	267
Dimmer status . . . . .	261
Enable . . . . .	258
Error messages, general . . . . .	259
Fatal messages . . . . .	328
Load check . . . . .	266
Record loads . . . . .	265
Secondary messages . . . . .	329
Set dimmer . . . . .	268
Unset dimmer . . . . .	268
ETCLink address . . . . .	258
ETCNet	
Install remote monitor . . . . .	325
Using ETCNet2 devices . . . . .	310
Wiring . . . . .	310
ETCNet2 devices	
Discover nodes . . . . .	320
Using on ETCNet . . . . .	310
Wiring . . . . .	310
ETCNet2 DMX Node . . . . .	310
ETCNet2 Video Node . . . . .	310
Events, Edit . . . . .	288
Express Serial Protocol (ESP) . . . . .	300
<b>F</b>	
Fade	
Multipart . . . . .	117
Rate . . . . .	126
Type . . . . .	80
Fade time	
Changing for submaster . . . . .	158
Effect . . . . .	214
Recording cue . . . . .	85, 86
Set cue default . . . . .	24
Subroutine . . . . .	221
Fader	
Back key . . . . .	121
Background . . . . .	4
Clear . . . . .	121
Default Clear Time . . . . .	25
Go . . . . .	121
Hold . . . . .	121
Manual . . . . .	125
Specifications . . . . .	343
Timed . . . . .	120
Fixture	
Definition . . . . .	7
Delete . . . . .	70
Label . . . . .	69
Only . . . . .	8
Release captured channels . . . . .	52
Solo check . . . . .	78
Fixture attribute	
About Channel . . . . .	60
Category . . . . .	71
Definition . . . . .	7
Print setup . . . . .	251
Reset defaults . . . . .	72
Setup . . . . .	72
Fixture box . . . . .	75
Fixture patch	
<i>(See, also, Patch)</i>	
DMX512 start . . . . .	69
Fixture box . . . . .	75
Flip . . . . .	69
Personality . . . . .	69
Print . . . . .	251
Remote dimmer . . . . .	69
Start channel . . . . .	69
Swap focus . . . . .	69
Flash . . . . .	57
Flexichannel	
Enable/Disable . . . . .	27
Purge Flexi . . . . .	18, 56
Sample macro . . . . .	235
Selecting channels . . . . .	56
Update . . . . .	18
Flip	
About Channel . . . . .	60
Explained . . . . .	53
Fixture patch . . . . .	69
Set . . . . .	54
Focus point	
Clear . . . . .	255
Defined . . . . .	141
Delete . . . . .	149
Maximum number . . . . .	141
Print . . . . .	251
Recording with solo . . . . .	143

Setting linked levels . . . . .	150	Installation	
Show/hide link . . . . .	144	Alphanumeric keyboard . . . . .	314
Spreadsheet . . . . .	186	Console lights . . . . .	316
Update . . . . .	145–146	Dimmers . . . . .	311
Use to park . . . . .	192, 195	ETCNet . . . . .	310
Use to set levels . . . . .	150	MIDI Show Control . . . . .	316
View on stage . . . . .	144	Printer . . . . .	315
Follow time, subroutine . . . . .	221	Remote Interface . . . . .	321
Follow, cue playback . . . . .	89	Remote macro . . . . .	317
Format diskette . . . . .	244	Remote monitors . . . . .	325
Frame rate . . . . .	286	RFU . . . . .	315
Full key . . . . .	57		
<b>G</b>		<b>J</b>	
Grandmaster . . . . .	28	Jumpers	
Group		Remote Interface . . . . .	322
Blind . . . . .	131	Jump-to-cue . . . . .	221
Clear . . . . .	255		
Copy to sub . . . . .	170	<b>K</b>	
Delete . . . . .	137	Keys	
Displaying . . . . .	133, 144	Back . . . . .	121
Group Editing mode . . . . .	131, 132	Clear . . . . .	121
Group mode . . . . .	131	Follow . . . . .	89
Label . . . . .	136, 305	Full . . . . .	57
List . . . . .	176	Go . . . . .	121
Load to sub . . . . .	169	Hold . . . . .	121
Modify cue or sub . . . . .	139	Learn . . . . .	226
Park . . . . .	194	Level . . . . .	57
Print . . . . .	251	Link . . . . .	88
Spreadsheet . . . . .	184	Rate . . . . .	126
Update . . . . .	134–135	Sub Page . . . . .	154
View on stage . . . . .	133	Type . . . . .	153
<b>H</b>		<b>L</b>	
Help . . . . .	2	Label	
Highest Takes Precedence (HTP)		Acceptable characters . . . . .	305
Explained . . . . .	4	Channel Attribute display . . . . .	53
Set . . . . .	55	Cue . . . . .	93
Hold		Fixture . . . . .	69
Fader key . . . . .	121	Focus point . . . . .	148
Submaster dwell . . . . .	159	Group . . . . .	136
Hold-for-Go (subroutine) . . . . .	221	Submasters . . . . .	168
Home position . . . . .	152	Latest Takes Precedence (LTP)	
<b>I</b>		About Channel . . . . .	60
Independent channel		Background override . . . . .	5
Explained . . . . .	53	Blocking cue . . . . .	6
Release . . . . .	52	Enable . . . . .	5
Set . . . . .	54	Overview . . . . .	4–6
Inhibitive submaster		Set . . . . .	55
defined . . . . .	152	Learn	
Programming . . . . .	162–163	Macro . . . . .	226
Insert		Time code events . . . . .	289
Cue, using record . . . . .	100, 105	LEDs	
Cue, using track . . . . .	106	Submaster . . . . .	156
Empty channel link . . . . .	240	Submaster type change . . . . .	153
		Level	
		In subroutines . . . . .	221

Set by focus point . . . . .	150	Master slider . . . . .	28
Level key		Master type setting . . . . .	28
Explained . . . . .	57	Memory . . . . .	33
Set . . . . .	25	Memory utilization . . . . .	33
Setting unlinked levels . . . . .	150	Menu	
Link		Clear Functions . . . . .	254
Creating . . . . .	239	Diskette Functions . . . . .	243
Cue to cue . . . . .	88	Print Functions . . . . .	250
Cues in playback . . . . .	88	MIDI	
Delete . . . . .	242	(See, also, <i>Time code program</i> )	
Insert . . . . .	240	MIDI Show Control	
Macro to cue . . . . .	91	(See, also, <i>ETC MIDI</i> )	
Macro to macro . . . . .	230	Commands . . . . .	276
Merge . . . . .	241	Configuring . . . . .	275
Move . . . . .	241	Disable . . . . .	275
Using . . . . .	242	Installation . . . . .	316
List		Interfacing with . . . . .	316
Cue/Command . . . . .	172	Message definitions . . . . .	274
Focus point . . . . .	177	Modify	
Group . . . . .	176	Cue attributes . . . . .	95
Submaster/Command . . . . .	173	Macro . . . . .	233
Littlites . . . . .	306	Multipart fade and wait . . . . .	117
Console lights . . . . .	306	Submaster . . . . .	164
Install . . . . .	316	Move Link . . . . .	241
Load		Moving channels, defined . . . . .	52
Cue or group to sub . . . . .	169	Moving light	
Load Check . . . . .	266	(See, also, <i>Fixture</i> )	
Personality . . . . .	66	Clear . . . . .	255
Lockout Record . . . . .	29	Fixture box . . . . .	75
Loop		Patching . . . . .	68–69
In subroutines . . . . .	221	Print . . . . .	251
Of cues . . . . .	90	Multipart cue	
<b>M</b>		Converting regular cue to . . . . .	113
Macro		Create . . . . .	112
Cancel . . . . .	232	Defined . . . . .	111
Clear . . . . .	233, 255	Editing . . . . .	115–117
Copy . . . . .	234	Modify fade/wait . . . . .	117
Creating . . . . .	226–228	Update part . . . . .	116
Display mode . . . . .	228	Wait time . . . . .	114
Edit . . . . .	233	Multipart cues	
Learn . . . . .	226	Definition . . . . .	111
Link to cue . . . . .	91	Delete part . . . . .	115
Link to macro . . . . .	230	Recording . . . . .	112
Macro Wait . . . . .	229	<b>N</b>	
Modify . . . . .	233	Name	
Play . . . . .	232	(See <i>Label</i> )	
Print . . . . .	251	Navigation	
Remote . . . . .	318	Attribute setup . . . . .	72
Remote Trigger . . . . .	301	Effect . . . . .	200
Samples . . . . .	234	Encoder setup . . . . .	74
Specifications . . . . .	346	Explained . . . . .	3
Sub-Bump . . . . .	231	Fixture Box, no encoders . . . . .	77
Manual		Fixture patch . . . . .	68, 70
Override cue . . . . .	125	Personality setup . . . . .	65
Override submaster fade . . . . .	167	Real time programs . . . . .	281

Submaster list . . . . .	174	Reset defaults . . . . .	67
Network requirements . . . . .	310	Setup . . . . .	65–67
<b>O</b>		View . . . . .	66
One-to-one patch . . . . .	36	Pile-on submaster, defined . . . . .	152
Only		Pinout	
Explained . . . . .	8	Alphanumeric keyboard . . . . .	314
Recall channels . . . . .	8	Dimmer . . . . .	311
Updating cue . . . . .	96–97	Monitor . . . . .	325
Updating effect . . . . .	207	Printer . . . . .	315
Updating group . . . . .	134–135	Remote Macro . . . . .	317
Optional equipment		Remote macros . . . . .	318
Alphanumeric keyboard . . . . .	314	RFU . . . . .	315
Remote Focus Unit . . . . .	315	Playback	
Output level conventions . . . . .	4	Cues . . . . .	119, 124
<b>P</b>		Groups . . . . .	133, 144
Page		Macro . . . . .	232
Channel . . . . .	14	Manual override . . . . .	125
Submasters . . . . .	154, 161	Specifications . . . . .	343
Paging through displays . . . . .	14	Playback display	
Park		Time Code list . . . . .	297
At focus point . . . . .	192	Port	
Channel . . . . .	192	Set Dimmer Doubling . . . . .	313
Cue . . . . .	194	Set DMX512 start . . . . .	312
Dimmer . . . . .	190	Print	
Fixture . . . . .	195	Options . . . . .	250
Group . . . . .	194	Printer . . . . .	315
Submaster . . . . .	194	Profile	
Unpark channel . . . . .	193	Assign . . . . .	41
Unpark dimmer . . . . .	191	Create . . . . .	42
Part		Pre-defined . . . . .	40
Create . . . . .	112	Reset . . . . .	255
Delete from multipart cue . . . . .	115	Proportional patching . . . . .	38
Modify fade/wait . . . . .	117	Purge Flexi . . . . .	18, 56
Update . . . . .	116	<b>Q</b>	
Parts . . . . .	112	Quickstep . . . . .	127
Patch		<b>R</b>	
(See, also, <i>Fixture patch</i> )		Rack Status . . . . .	262
1-to-1 . . . . .	36	Rate	
Captured channels . . . . .	44	Override . . . . .	126
Custom . . . . .	37	Submaster . . . . .	160, 167
Dimmer . . . . .	37	Update . . . . .	98
Display . . . . .	19	Real Time Clock	
Editing . . . . .	70	Set . . . . .	30–32
Proportional patch . . . . .	38	Using . . . . .	280
Reset 1-to-1 . . . . .	255	Real time programs	
Pause fade . . . . .	121	About . . . . .	280
Pending cues . . . . .	124	Astronomical clock . . . . .	283
Personality		Clear . . . . .	255
About Channel . . . . .	60	Create . . . . .	282
Defaults . . . . .	65	Enable/Disable . . . . .	281
Definition . . . . .	7	Print . . . . .	251
Fixture patch . . . . .	69	Record	
Load . . . . .	66	Cue . . . . .	87
Print . . . . .	251	Dimmer loads . . . . .	265

Disable with Lockout . . . . .	29
Explanation . . . . .	81
Follow . . . . .	89
Link cues . . . . .	88
Multipart cues . . . . .	112–115
Record Lockout . . . . .	29
Recorded channels . . . . .	52
Recording cue with Solo . . . . .	92, 131
Recording focus point with Solo . . . . .	143
Sub minus sub . . . . .	161
Submasters . . . . .	155, 157
Recorded channels defined . . . . .	52
Release captured channels . . . . .	52
Remote dimmer, patching . . . . .	69
Remote Focus Unit (RFU)	
About . . . . .	304
Installation . . . . .	315
Remote Interface	
DIP switches/jumpers . . . . .	322
Installation . . . . .	321
Software upgrade . . . . .	319
Remote Macro	
Installation . . . . .	317
Remote Macro connectors . . . . .	317
Remote Trigger . . . . .	301
Remote Unit Upgrade display . . . . .	320
Remote Video Interface	
DIP switch settings . . . . .	324–325
Software upgrade . . . . .	319
Reset	
Categories . . . . .	72
Dimmer profiles . . . . .	43
Encoders . . . . .	74
Fixture attributes . . . . .	72
Profiles . . . . .	255
Reset system . . . . .	254
<b>S</b>	
Selected channels defined . . . . .	52
Sensor	
Backup looks . . . . .	269
Dimmer Doubling . . . . .	48
Monitoring . . . . .	257, 264
System status . . . . .	261
Serial interface . . . . .	300
Set	
Channel levels . . . . .	51, 59
Channels to submasters . . . . .	28
Clock . . . . .	30–32
Default fade time . . . . .	24
Default fader clear time . . . . .	25
Default level . . . . .	25
Default sneak time . . . . .	26
Dimmer . . . . .	268
Dimmer levels . . . . .	45
Grandmaster type . . . . .	28
Latitude . . . . .	32
Level key . . . . .	25
Longitude . . . . .	32
LTP/HTP channel . . . . .	55
Master type . . . . .	28
Time zone . . . . .	32
Show	
Clear . . . . .	255
Showfile	
Configuration contents . . . . .	331
Explained . . . . .	245
Show contents . . . . .	331
Single mode . . . . .	9
Slider	
Master . . . . .	28
Slider, Master . . . . .	28
SMPTÉ	
<i>(See Time code program)</i>	
Sneak	
Set default time . . . . .	26
Use . . . . .	58
Softkeys	
About . . . . .	15
Flash . . . . .	57
Quickstep . . . . .	127
Unload sub . . . . .	170
Software	
Upgrading a console . . . . .	319
Upgrading remote interfaces . . . . .	319
Solo	
Fixture focus . . . . .	78
Recording a cue . . . . .	92, 131
Recording a focus point . . . . .	143
Specifications . . . . .	343–347
Split fade times . . . . .	86
Spreadsheet	
Cue . . . . .	179
Focus point . . . . .	186
Group . . . . .	184
Submaster . . . . .	182
Step	
Delete . . . . .	212
Insert . . . . .	210
Subroutine . . . . .	220
Strand CD80 . . . . .	49
Style step . . . . .	221
Sub Grandmaster . . . . .	28
Submaster	
Changing shows . . . . .	154
Changing type . . . . .	153
Clear . . . . .	170, 255
Command display list . . . . .	173
Copy . . . . .	169
Copy cue or group . . . . .	170
Default match to channels . . . . .	28

Dwell hold	159
Effect	152, 217
Except	161
Fade and dwell times	157
Fade times	158, 167
Home position	152
In macros	231
Inhibitive	152, 162
Label	168, 305
LEDs	154, 156, 162
List	167
Load cue or group	169
Load effect	217
Manual fade	167
Modifying	164
Override fade time	167
Pages	154, 161
Park	194
Pile-on	152
Print	251
Range edit in Submaster List	174
Rate	160, 167
Record	157
Recording	161
Sliders	167
Specifications	344
Spreadsheet	182
Types	152
Subroutine	
About	80
Allfade cue steps	220
Bounce style steps	221
Creating	222
Crossfade cue steps	220
Cue steps	220
Deleting step	224
Editing	224
Hold for go style steps	221
Inserting step	224
Level	221
Loop	221
Style steps	221
Times, fade and follow	221
Swap focus, fixture	69
Swap twisted pair	310, 320
System settings	
Default Fade Time	24
Default fade time	24
Default Fader Clear Time	25
Default level	25
Flexichannel	27
Number of channels	23
Number of dimmers	22
Record Lockout	29
Set Channels/Subs 1-to-1	28
Set time and date	31
System software upgrade	319
System Status	261
<b>T</b>	
Technical Services	11
Thinnet	310
Time	
Default fade	24
Effect fade time	214
Effect Up/Dwell/Down	214–215
Follow time	89
Macro Wait	229
Set clock	30
Set system	32
Submaster	157–161
Subroutine fade and follow	221
Wait	87
Wait time in multipart cue	114
Time code event	
Clear all	255
Delete	292
Learn Mode	289
Print	251
Time Code list	297
Time code program	
Copy event	293
Edit event	295
External clock	298
Insert an event	292
Internal clock	297
Manual Mode	299
Manual playback	299
Move event	294
Pause Mode	299
Playback	297
Range edit	295
Reset loop	291
Setting frame rate	286
Step softkey	299
Timed fader	120
Track	
About	101
Allfade	108
Channel color	52
Explanation	81
Trackpad	9
Sensitivity	9
Troubleshooting	10
Twisted pair wiring	310
Type	
Cue	80
Submaster	152
<b>U</b>	
Unload submaster	170

Unpark	
Channel	193
Dimmer	191
Fixture	196
Unpatch dimmer	39
Unset Dimmer	268
Update	
Channel 0	8
Cue	96–97
Effect	207
Flexichannel	18, 56
Focus point	145–146
Group	134–135
Only	8
Rate	98
Upgrading software	319
Using remote keyboard	305
<b>V</b>	
Viewing cues	81
<b>W</b>	
Wait time	
Assign to part	114
Edit for part	117
Record cue	87
Website	11
Wheel	
Link channels	242
Pan and tilt	77
Worklights	306
<b>X</b>	
XY mode	9