

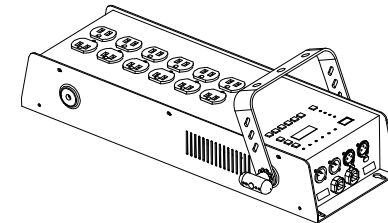

DP-640B



Instruction Manual

Notes

Technical Specifications

Technical Specifications

Power Input	2x20A, AC 120V~50/60Hz
Line cord.....	2x12AGWx3C VW-1 105 C
Load.....	2400W Channels 1~3, 2400W Channels 4~6
MCB (x2)	20A Each
Dimensions	19.7"x6.57"x3.66"(500x167x93mm)
Weight(approx.)	7.5lbs.(3.4 kg)

Dimensions in detail: (mm)

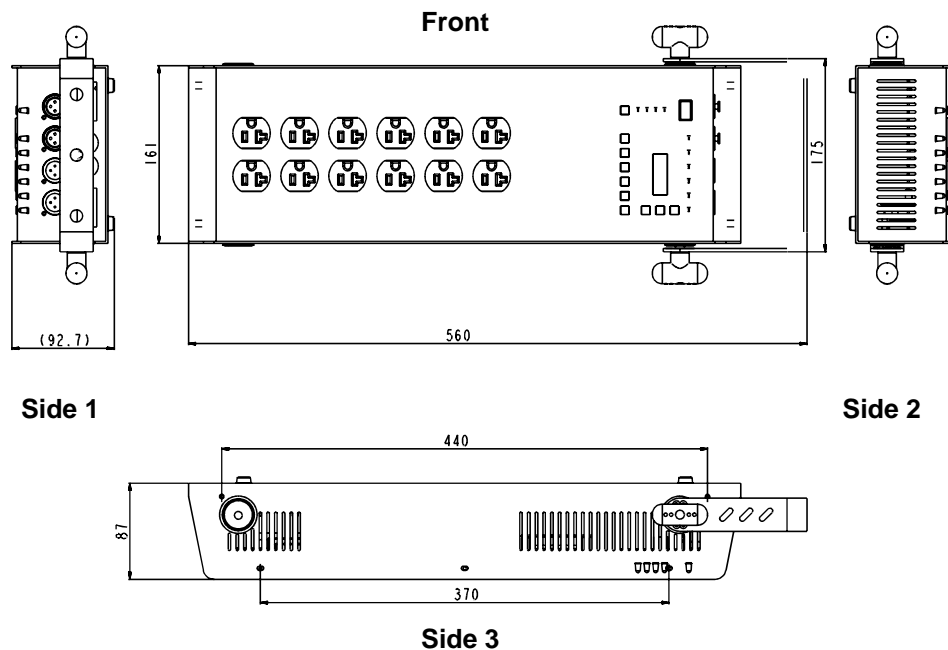

Table of Contents

Features	1
General Instruction.....	2
Warnings.....	2
Cautions.....	2
Control and Functions.....	3
Front View.....	3
Rear View.....	4
LED-display & Control buttons.....	4
Operation Guide.....	5
Function Mode 1: DMX Address (001~512).....	5
Function Mode 2: Patch Address (001~512).....	6
Function Mode 3: Local Control (000~100).....	7
Function Mode 4: Dimmer/Switch.....	8
Operation, Installation & Connections.....	9
PANIC dip-switches 1~6.....	9
Installation/Mounting.....	9
Connections.....	9
Troubleshooting.....	10
Technical Specifications	11

Features

Thank you for purchasing the DP-640B hybrid pack. This product includes the following features:

- 6 channel hybrid pack with dual Edison sockets per channel.
- 3 & 5 pin XLR inputs and outputs.
- Each channel can be assigned to Dim or Switch modes.
- 4 function LED's for DMX Address, Patch Address, Local Control and Dim/Switch modes.
- On board Local Control allows for dim intensity adjustment, from 0-100%, for each individual channel.
- Panic function dip switches.
- Dual 20A/AC120V Power line cords.
- Digital LED-display.
- Two 20 Amp circuit breakers.

Every effort has been made to design dependable and reliable products. New products are constantly being designed to meet the needs of the entertainment lighting industry. Your comments regarding our products and services are welcome. Please send any comment to info@elationlighting.com and let us know how we can improve to better serve you.

It is both a privilege and a pleasure to serve you.

Troubleshooting

Troubleshooting

No Power to the pack:

Disconnect the main power line cord. Reconnect the line cord to ensure proper connection. If the problem still persists, check the building service panel and make sure the circuit breakers are in the ON position.

No Channel output:

Disconnect the main power line cords. Check the circuit breakers to ensure they are in the ON position. Reconnect line cords. If controlling via DMX, ensure that you are receiving DMX signal at the pack. Indicator in the display should be flashing when signal is present. If signal is not present, check the XLR connections from console or previous fixture in line. If problem still persists, replace XLR cable between previous device and pack and try again.

Undesired 100% channel switch output:

Flip all "PANIC" dip switches to the OFF position. If problem still persists, check the "LOCAL CONTROL" settings and reset channels by pressing the corresponding channel button two times so that the channel LED turns OFF. Then press the "OK" Button store the settings.

If you've tried the above and the unit continues to malfunction, please contact ELATION® customer service at (323) 582-3322, your unit will require service. Once you describe your problem to the customer service representative, you will be issued a return authorization number that must accompany the package when sent in. Please write this RA# on the outside of the box with a black marker and also write it on any packing list that may be included with the package.

Operation Guide

PANIC dip-switches 1~6:

The Panic feature allows you to select desired channels, via dip switches 1-6, to be constantly on.

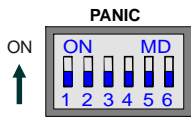

Flip the dip switches of the desired channels to the "ON" position. The selected channels will output 100%. Note: When operating with DMX control, corresponding channels, with dip switches set to "ON", will output 100% while channels with dip switches set to the "OFF" position can be controlled from the DMX console.

Installation / Mounting

The DP-640B was designed to be mounted or free standing. It is recommended that you use a suitable mounting clamp and safety cable when mounting clamp and rigging to a truss structure. There are two sets of threads on the DP-640B. They are in place for the mounting bracket. Use the bracket knobs and washers to secure the mounting bracket to either side of the pack. For cooling purposes, it is necessary to mount the pack so that air is free to circulate around the dimmer. There should be at least 12 inches of clearance between the pack and anything surrounding it.

Connections

The DP-640B is supplied with dual 20 Amp Edison plugs attached to 12 gauge line cords. These cords should be connected to a service capable of supplying 20 amps per line cord and be protected by a properly sized main circuit breaker. Lamp loads should be plugged into the dual 20 Amp Edison sockets which are supplied on the face of the pack. 3 & 5 pin XLR's are supplied for the DMX input and output of the data link. Connect out of the DMX controller or previous fixture in line and into the input of the DP-640B. Connect out of the DP-640B and into the input of next pack or fixture in line. It is recommended that the last pack or fixture in line include a DMX terminator into the output. A DMX terminator consists of a 120 ohm, 1/4 watt resistor soldered across pins 2 & 3 of a standard 3 or 5 pin XLR connector.

General Instruction

This is a 6 channel portable dimmer/pack. Each channel can individually be set to dim or switch as well as accept separate DMX Addresses. For your convenience, each channel can manually be controlled via our simple to use, digital display and function buttons. The Panic function allows you to select desired channels to switch ON constantly via the six dip switch settings. The unit is also supplied with 3 & 5 pin XLR connectors. The aluminum case makes the DP-640B one of the lightest portable dimmers of its kind.

To optimize performance of this product, please read these instructions carefully to familiarize yourself with the basic operations.

⚠ Warnings

- Be sure that this unit is properly grounded.
- Keep this unit dry, do not expose it to water or high levels of humidity.
- Do not allow for any flammable liquids to come in close contact with this unit.
- Handle this unit carefully, any strong shocks or vibration may result in damage.
- Do not operate this unit if the internal components are exposed.
- Only use an AC source that complies with the local building and electrical codes.

⚠ Cautions

- When unpacking, please check the unit for the damages. Should you find something wrong with the unit, please contact the dealer that you purchased it from immediately.
- All rights reserved. No part of this manual may be reproduced, in any form or by any means, without permission in writing from Elation Professional.

Notice:

Specifications and improvements in the design of this product and this manual are subject to change without written prior notice.

Control and Functions

Overall Layout

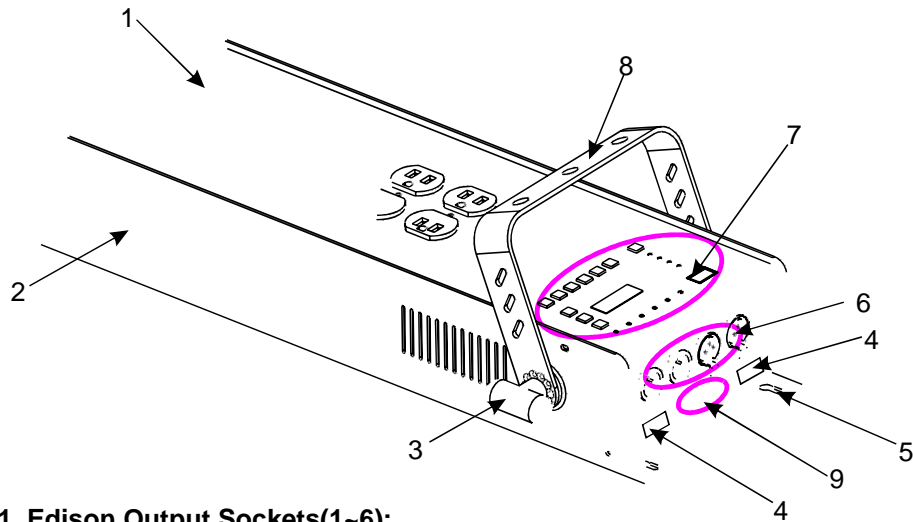

1. Edison Output Sockets(1~6):

These are dual 120V Edison sockets for output. Each socket is labeled with the relevant channel number. Up to 20Amps can be connected into each channel.

2. Threaded Openings:

These openings are supplied so the user can fasten the mounting bracket to the desired side.

3. Bracket Knobs:

These knobs are used to fasten the hanging bracket to the chassis.

4. Resetable Circuit Breakers(x2pcs):

These two 20A circuit breakers, protect the corresponding internal components from damage if there were ever a short circuit or voltage spike.

5. Mounting Slots:

These slots are in place so the user could permanently mount the unit if desired.

6. Connectors:

These are the DMX Input/Output connectors. There are 3 & 5 pin XLR inputs and outputs.

7. Control Section:

These buttons are used to adjust relevant settings within the display.

8. Mounting Bracket:

This mounting bracket is used to fasten the unit to a truss structure.

9. Power Inputs:

These supply power to the relevant channels when connect. Line cord 1 supplies power to channels 1-3 and line cord 2 to channels 4-6.

Operation Guide

Function Mode 4: Dimmer/Switch

This menu option allows you to set the pack's channels to dim or switch. Each channel can be individually set to do one or the other. When a channel is set to switch, then that channel will activate when the channel level exceeds 50%. When a channel is set to dim, then that channels intensity can manually be adjusted from 0 to 100%.

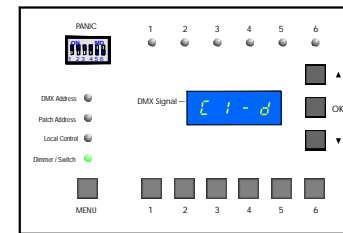

Press the MENU button until the "Dimmer/Switch" LED illuminates. The display will read either "C 1 - d" or "C 1 - s" depending on the current setting. The "C" indicates "Channel". The number that follows is the pack's channel number. The "d" indicates "Dim" and "S" indicates "Switch". In the example to the left, it shows channel 1 is currently set to dim.

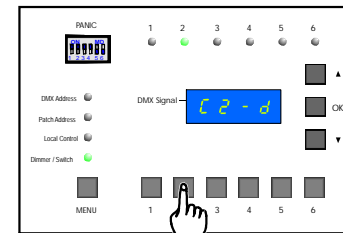

(1) Select the channel that you wish to assign by selecting from buttons 1-6. Only one channel can be assigned at a time.

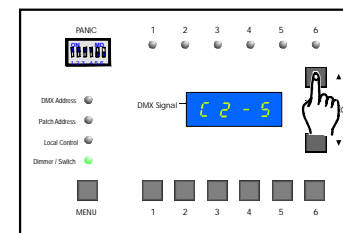

(2) Press the UP/ Down button to change the current setting. d="Dim"/s="Switch"

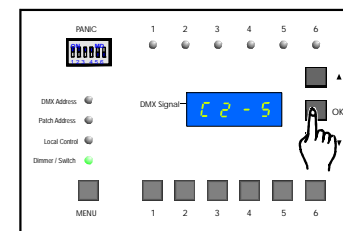

(3) Press "OK" button to confirm and save your setting. The display will momentarily flash confirming that your setting was stored. Repeat steps 1, 2 and 3 to assign additional channels. These settings will be stored to memory.

Operation Guide

Function Mode 3: Local Control (Manual)

The Local Control option allows for manual control of the packs six channels via the on-board buttons.

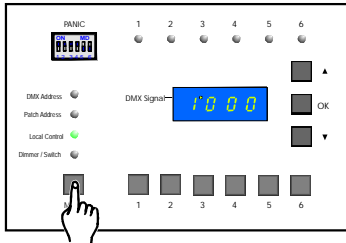

Press the MENU button until the "Local Control" LED illuminates. The display will read **1000**. This means that channel 1 output level is currently set to 0.

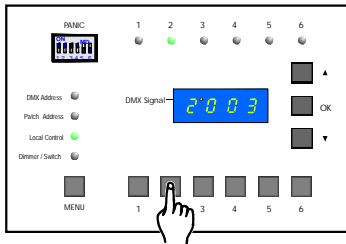

(1) Select the channel that you wish to manually control by selecting from buttons 1-6. Only one channel can be selected at a time.

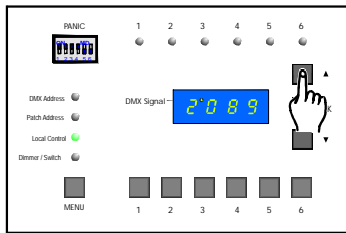

(2) Press the UP/ Down button to adjust the dim value to your desired setting. The dim range is from 000 to 100%.

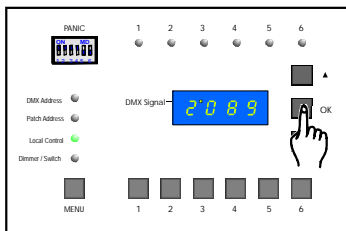

(3) Press the "OK" button to confirm and save your setting, the display will momentarily flash confirming that your setting was stored. Repeat steps 1, 2 and 3 to manually set additional channel levels and store them. These settings will be stored to memory until you dis-engage the set channels.

Control and Functions

Data & Power Connections

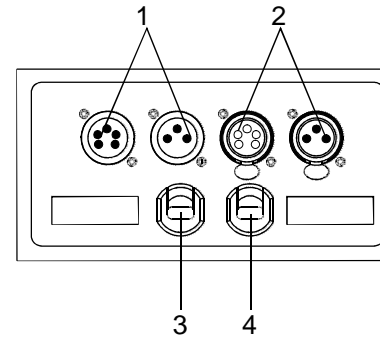

- DMX IN:**
3 & 5 Pin (male) input socket.
- DMX OUT:**
3 & 5 Pin (female) output socket.
- Power 1:**
Power cord 1- powers channels 1~3, 2400 watts.
- Power 2:**
Power cord 2- powers channels 4~6, 2400 watts.

LED-display & Control buttons

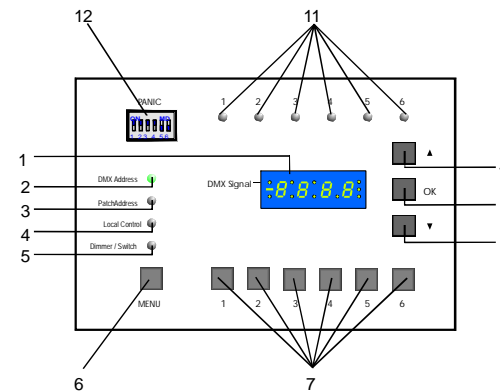

- LED-display:** displays the current value and function mode-including a DMX signal indicator.
- DMX Address LED:** this LED illuminates when in DMX mode.
- Patch Address LED:** this LED illuminates when in Patch mode.
- Local Control LED:** this LED illuminates when in Manual Control mode.
- Dimmer/Switch LED:** this LED illuminates when assigning dim/switch modes.
- Menu Button:** The menu button allows you navigate through function modes.
- Channel Buttons 1~6:** These buttons are used to select relevant channels.
- Down Button:** This button decreases values and selects desired function modes.
- OK Button:** This button confirms and saves relevant settings.
- UP Button:** This button increases values and selects desired function modes.
- Channel 1~6 LEDs:** Indicate output for relevant channels.
- Panic dip-switches:** These switches are used to activate selected channels to full ON when DMX signal is not present.

Operation Guide

***Note:** Abbreviations within the display represent the following:
A=Address, **C**=Channel, **d**= Display, **s**=Switch.
 Press the MENU button to navigate through the menu options. Continually pressing the MENU button will loop through the four options as illustrated below. When in each function mode, its LED will illuminate.

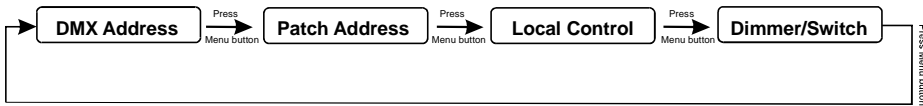

Function Mode 1: DMX Address (Block)

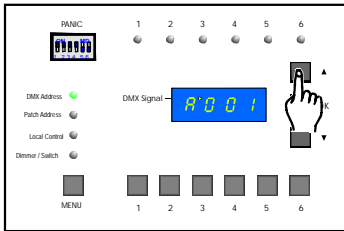

(1) This function is used when setting the starting DMX address channel for the pack. Use the UP/DOWN buttons to adjust to a desired setting. The selected DMX channel will be the DMX starting address for the pack. A total of six DMX channels will be occupied by the DP-640B in sequence, starting with the set channel.

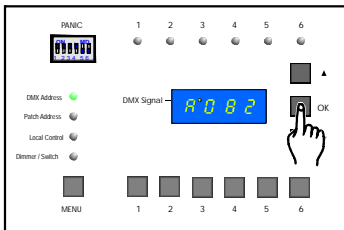

(2) Press the "OK" button to confirm and save your setting, the LED-display will momentarily flash confirming that your address was stored.

Operation Guide

Function Mode 2: Patch Address (Individual)

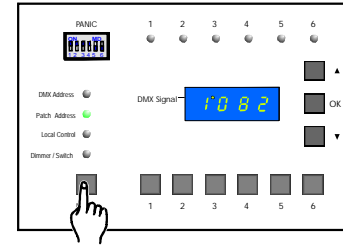

Press the MENU button until the Patch Address LED illuminates. The display will show you the current patch setting for channel 1. For example, if channel 1 was set to DMX channel 82, the display would read the following: '1'082'. The number 1 in the display indicates channel 1 of the pack. The next three digits indicate the current DMX address for the selected channel.

Note: If you set a starting DMX address channel in the DMX address option, channel one from the pack will assume that address channel and channels 2 through 6 will automatically be assigned a sequential DMX channel based on the channel 1 address.

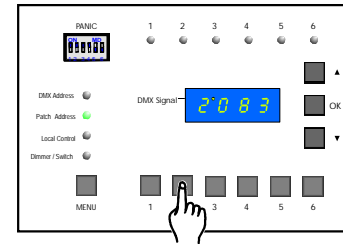

(1) Select a channel button that you want to address. Use the UP/DOWN button to adjust the channel setting. The address can be set anywhere between 001-512.

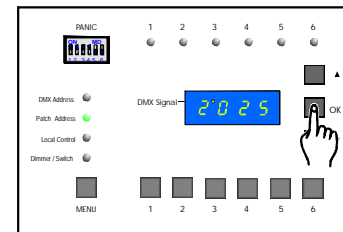

(3) Press the "OK" button to save your setting. The display will momentarily flash confirming that your patch setting has been stored. Repeat setp1 & 2 to patch additional channels.